

موقع دروس تعليمية اون لاين

How to master

English letters



• Primary •
Stage

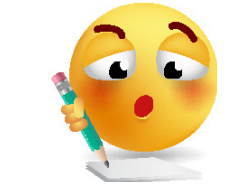

انقذ عبقرية ابنك

Mr. Mahmoud Mandouh

www.droos4online.com

01015219549

01015219549



الهدف من تمارين التشابهات والإختلافات هي تنمية عامل التركيز
لدي الأطفال في هذا السن المبكر.
ساعد الطفل في إيجاد الصورة التي لانتطابق مع الصور الأخرى.

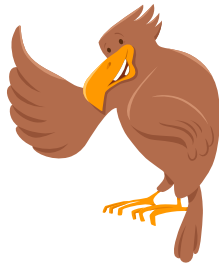
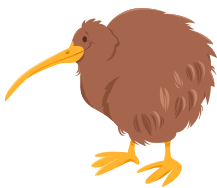



هام جداً

تعتبر عملية ما قبل تعلم مهارات الكتابة مرحلة هامة جداً عند الأطفال للأسباب التالية :

- يُمكن للطفل أن يمسك القلم الرصاص أو الجاف بطريقة صحيحة.
- يُمكن للطفل السيطرة الجيدة علي القلم الرصاص أو الجاف.
- يتعلم الطفل الكتابة من جهة اليسار إلي الجهة اليمني.
- هُنَاكَ تعاون بين يد الطفل وبين عينيهِ ويكتسب الطفل مهارات مرئية جيدة من خلال تعاون بعض أعضاء جسمه معاً.



Activity 2

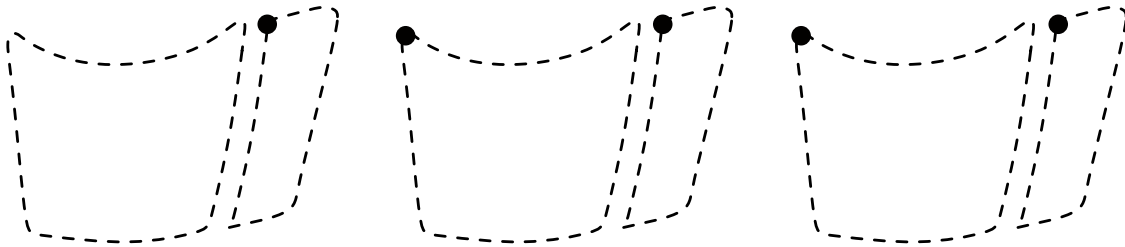
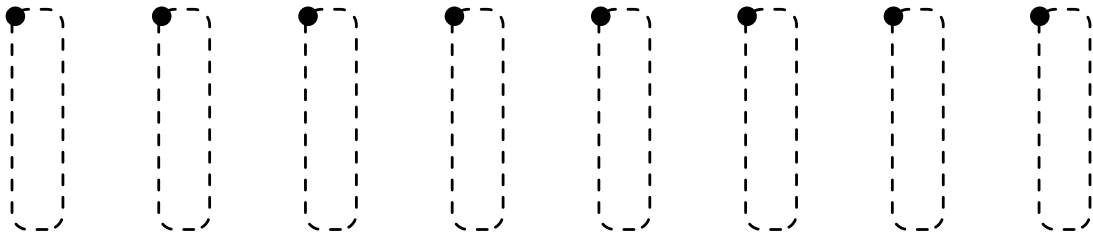
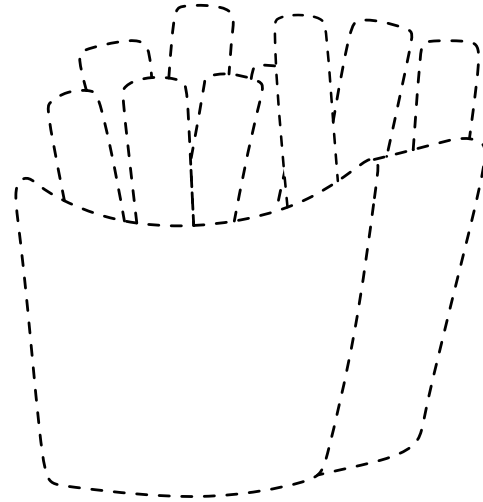
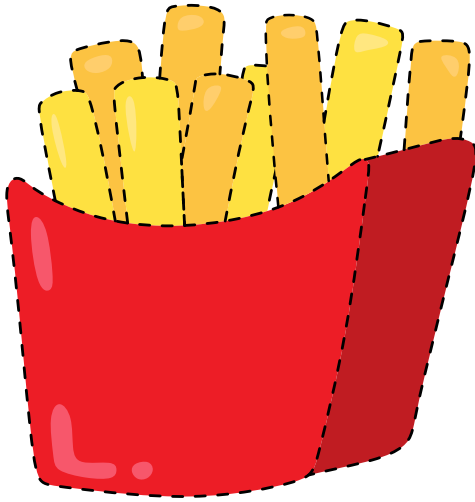



- تحتوي اللغة الإنجليزية على ٢٦ حرفاً هي مجموع الرموز المتعارف عليها والمستخدمه في عملية الكتابة ولكل نوع استخداماته.
- **لاحظ أن:** صوت الحرف، هو الصوت الذي نسمعه عند نطقنا لحرف محدد داخل كلمة تحتوي على هذا الحرف.



Aa Bb Cc Dd Ee
Ff Gg Hh Ii Jj Kk
Ll Mm Nn Oo Pp
Qq Rr Ss Tt Uu
Vv Ww Xx Yy Zz



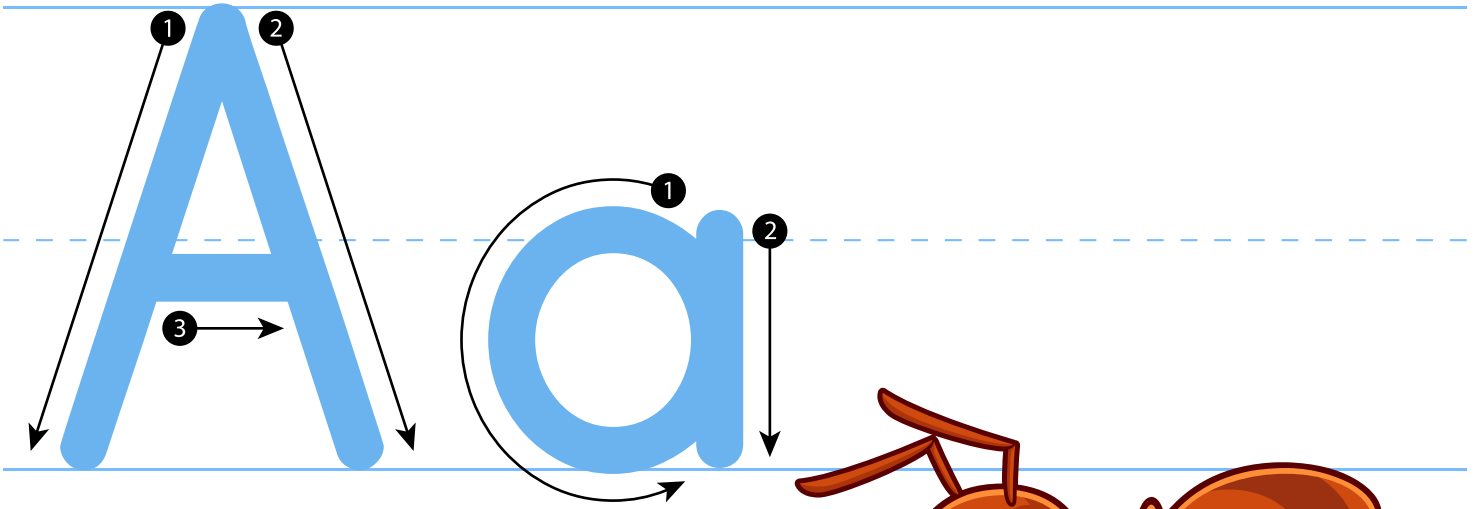

A is for Ant

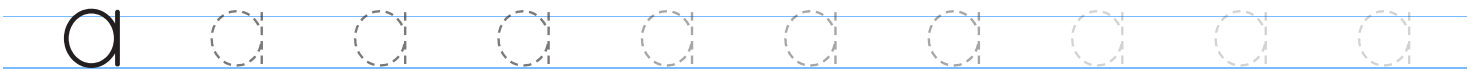
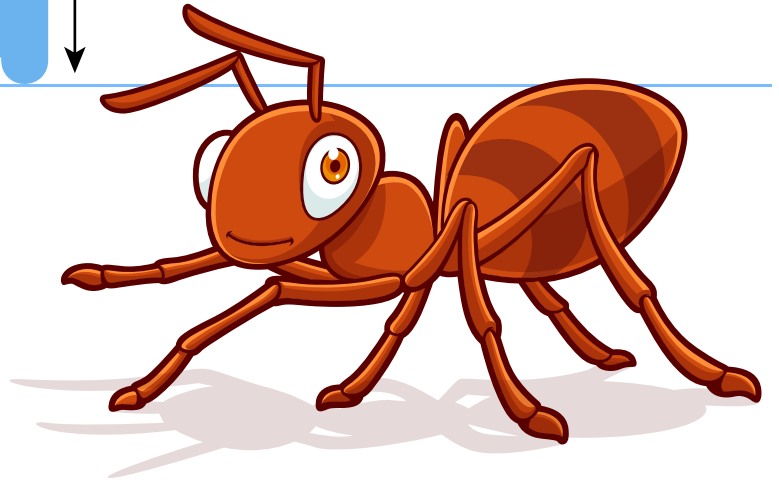

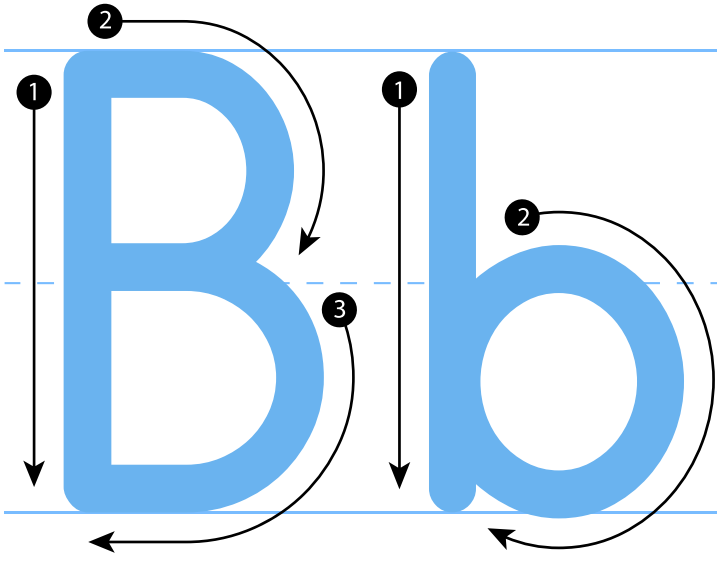

B is for Bear

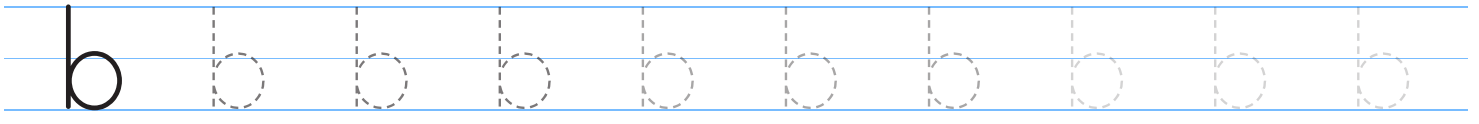
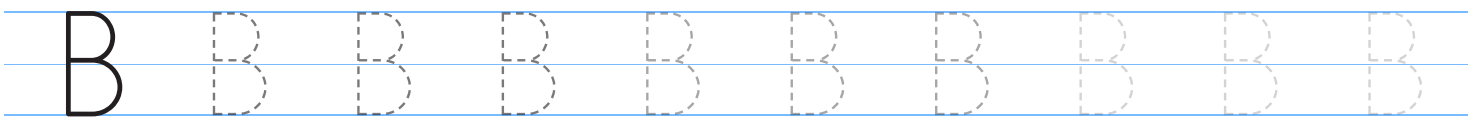

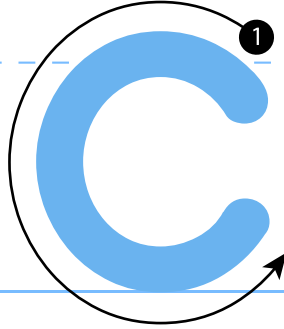
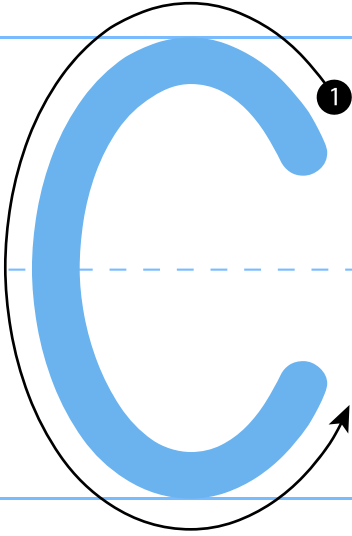

C is for Crab

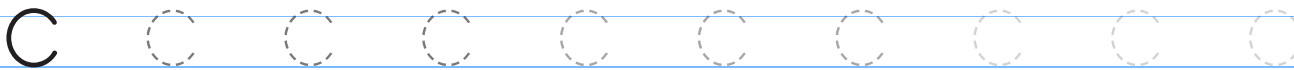
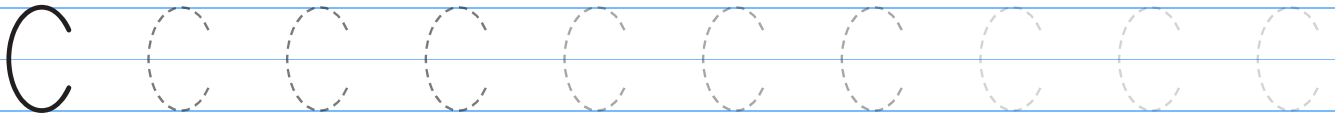

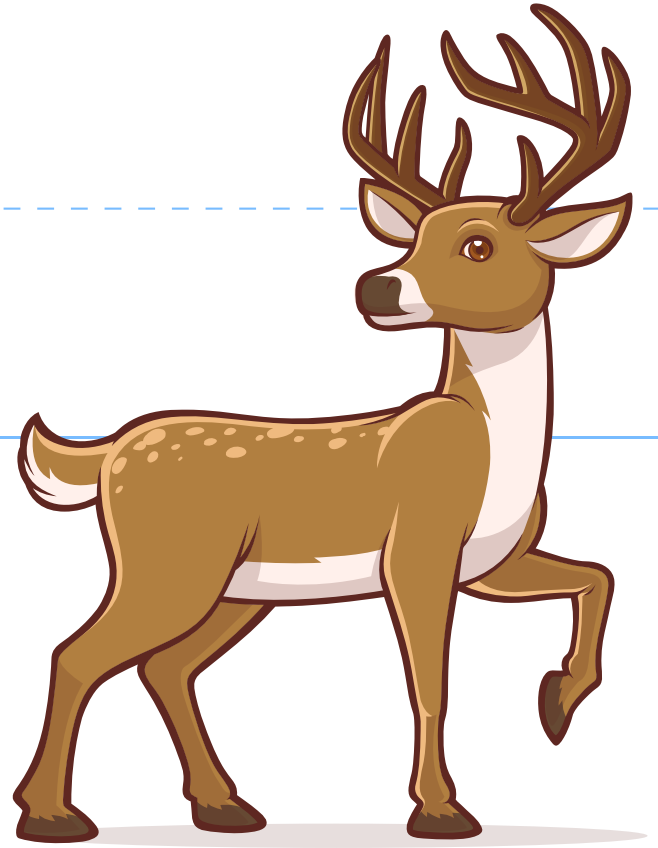
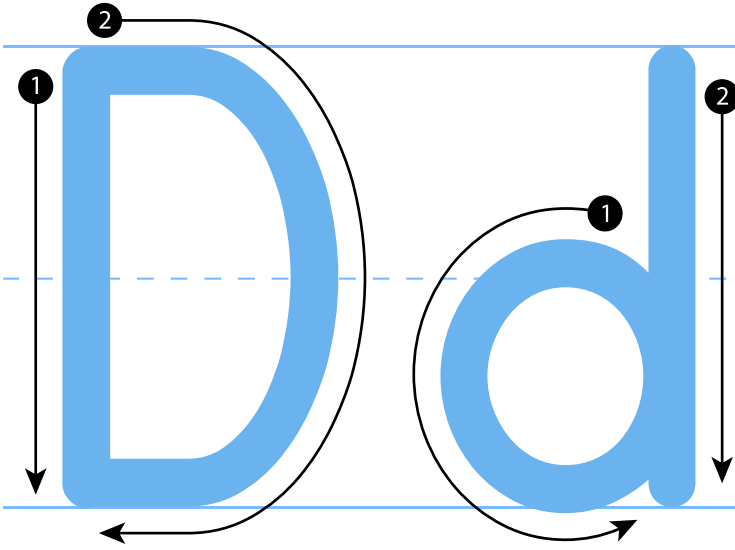

D is for Deer

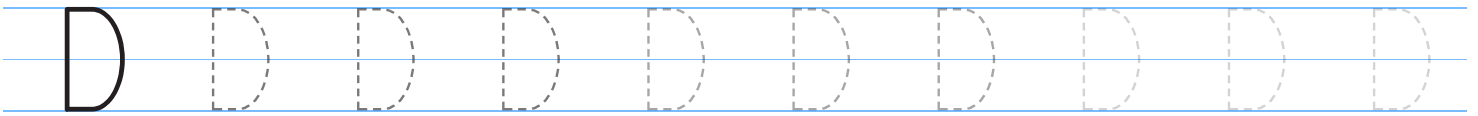

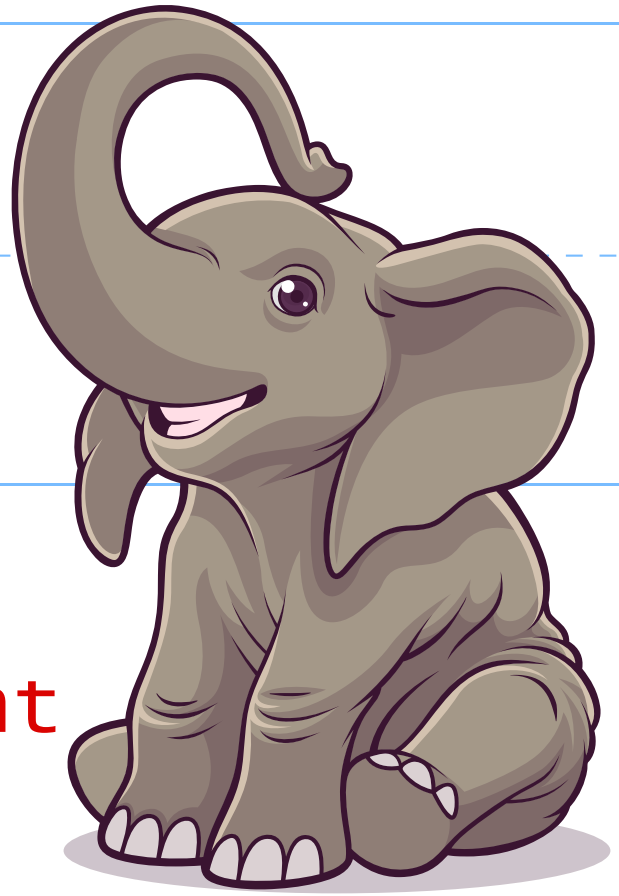
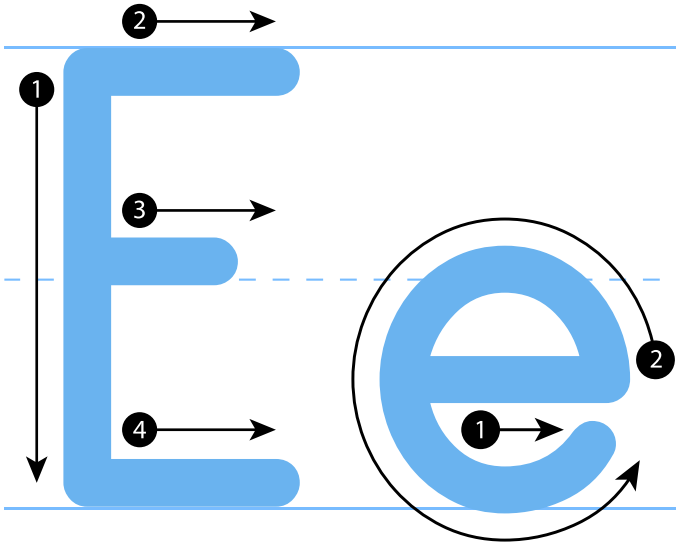

E is for Elephant

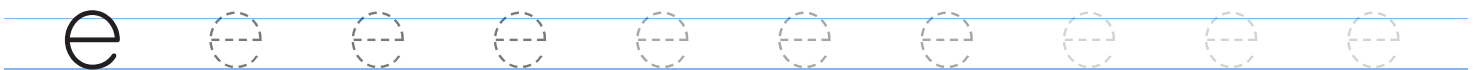

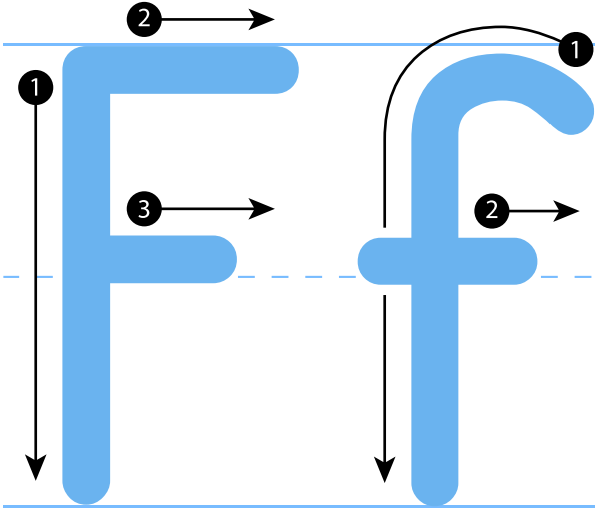

F is for Frog



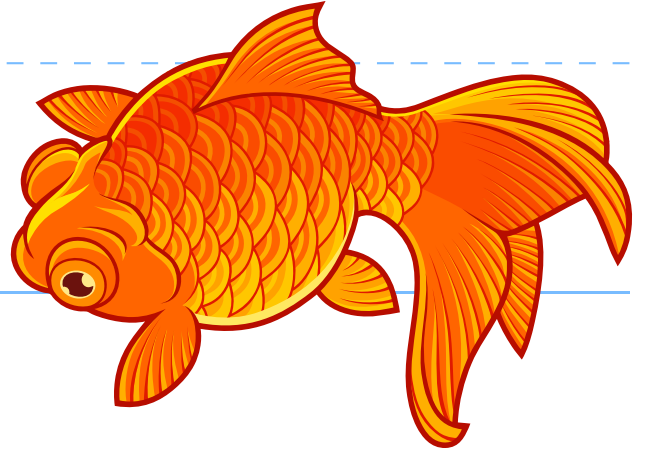
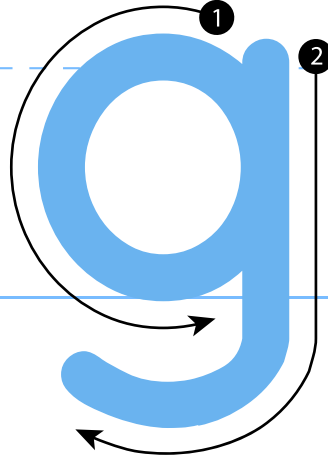
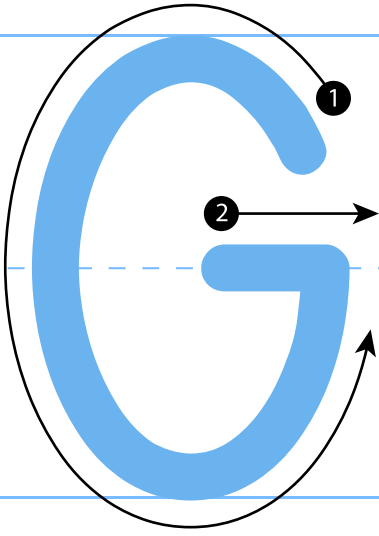

G is for Goldfish



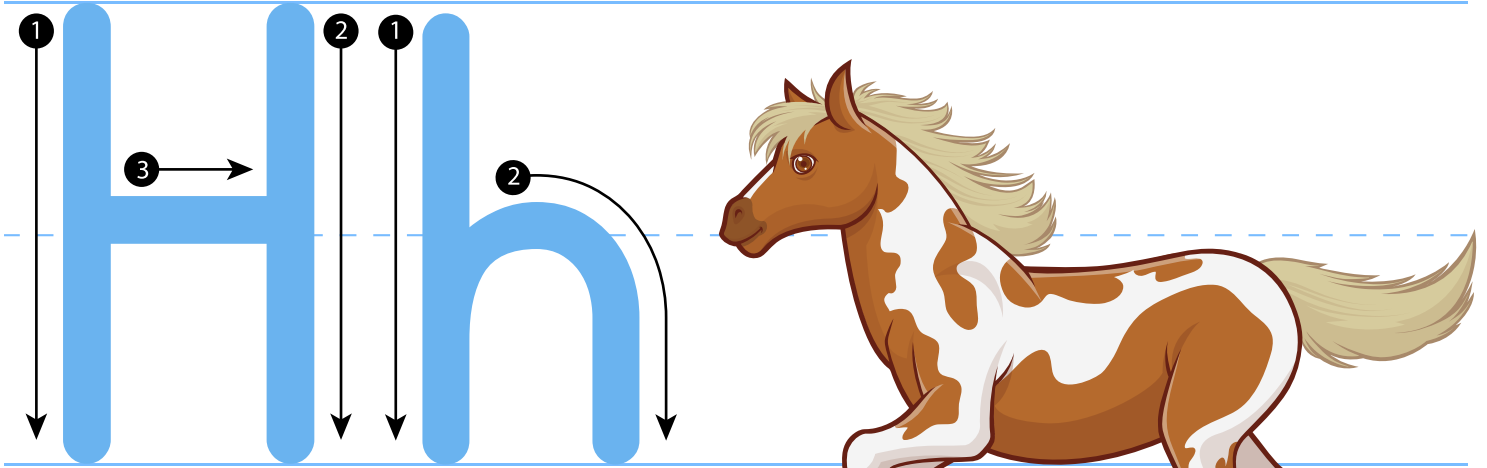

H is for Horse

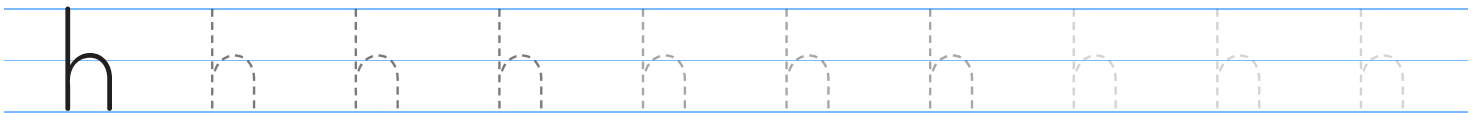
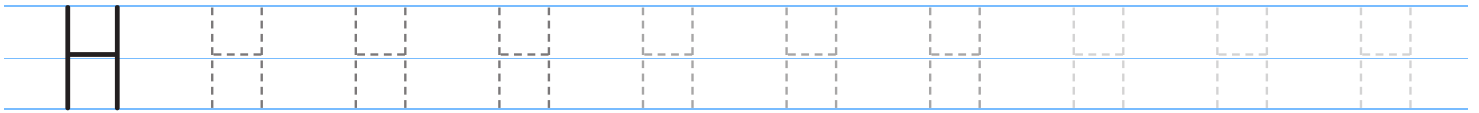

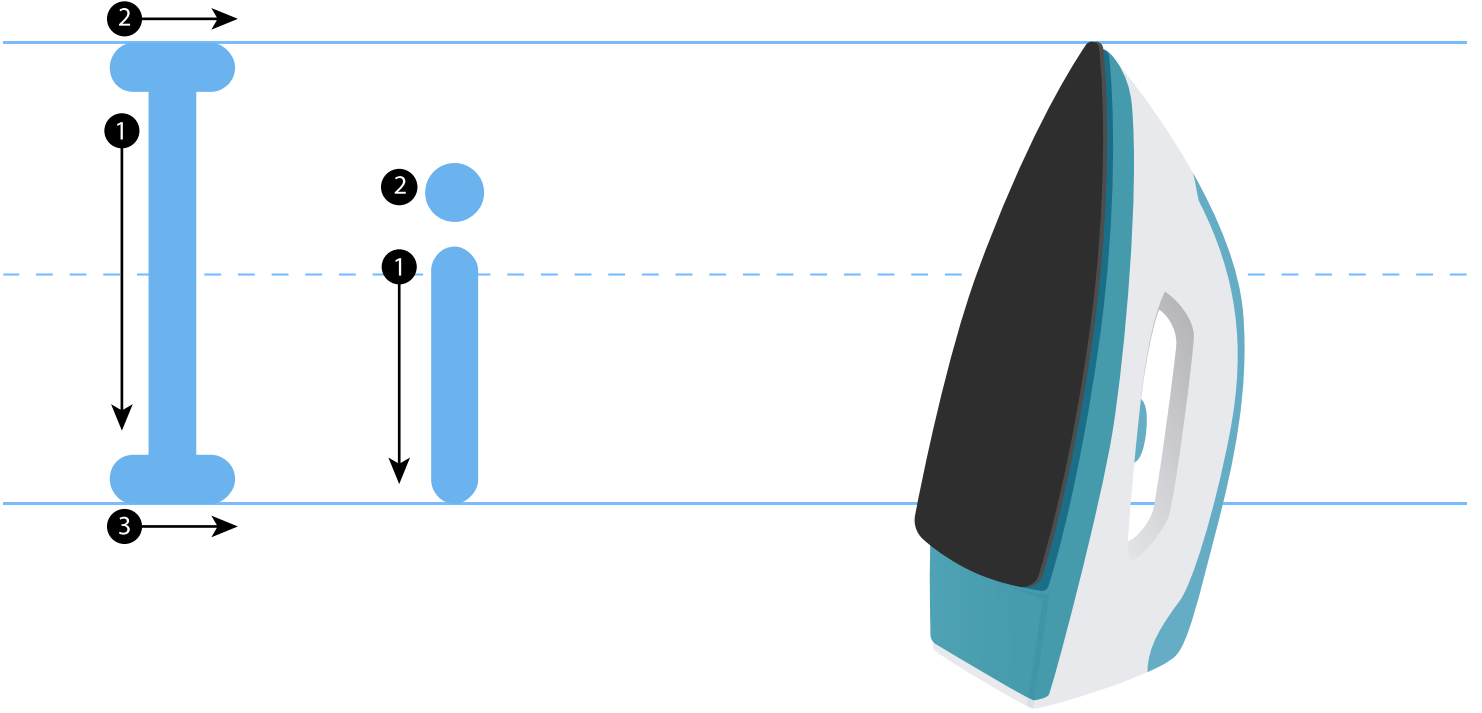

I is for Iron

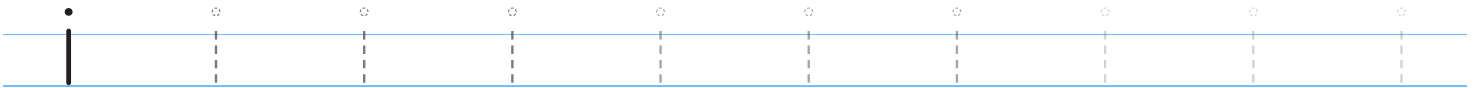
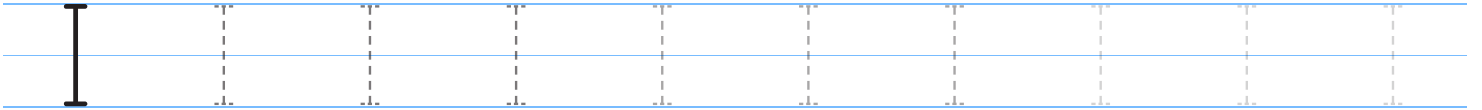

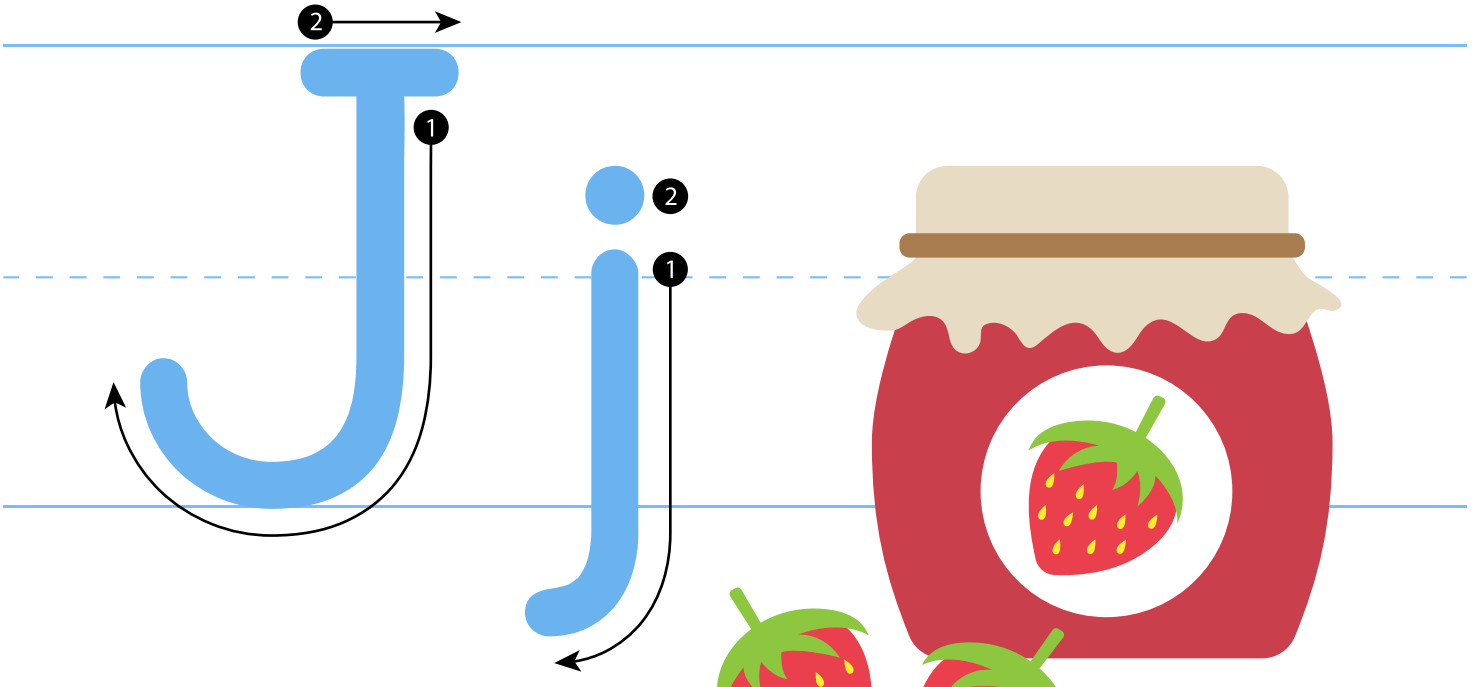

J is for Jam

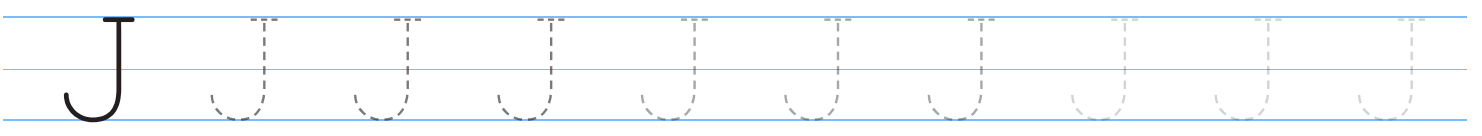

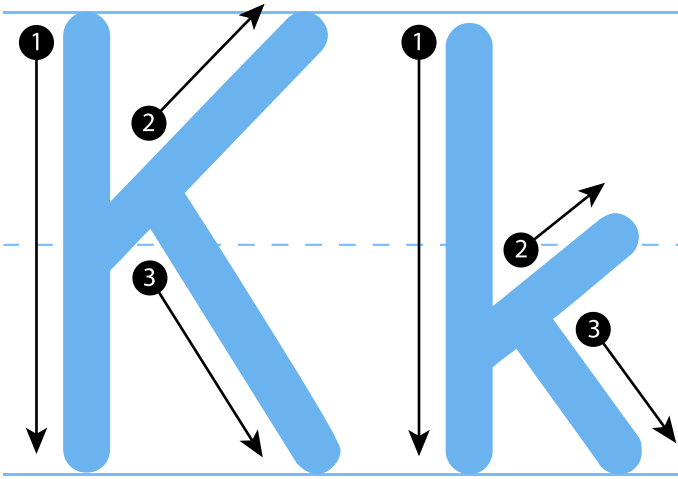

K is for King



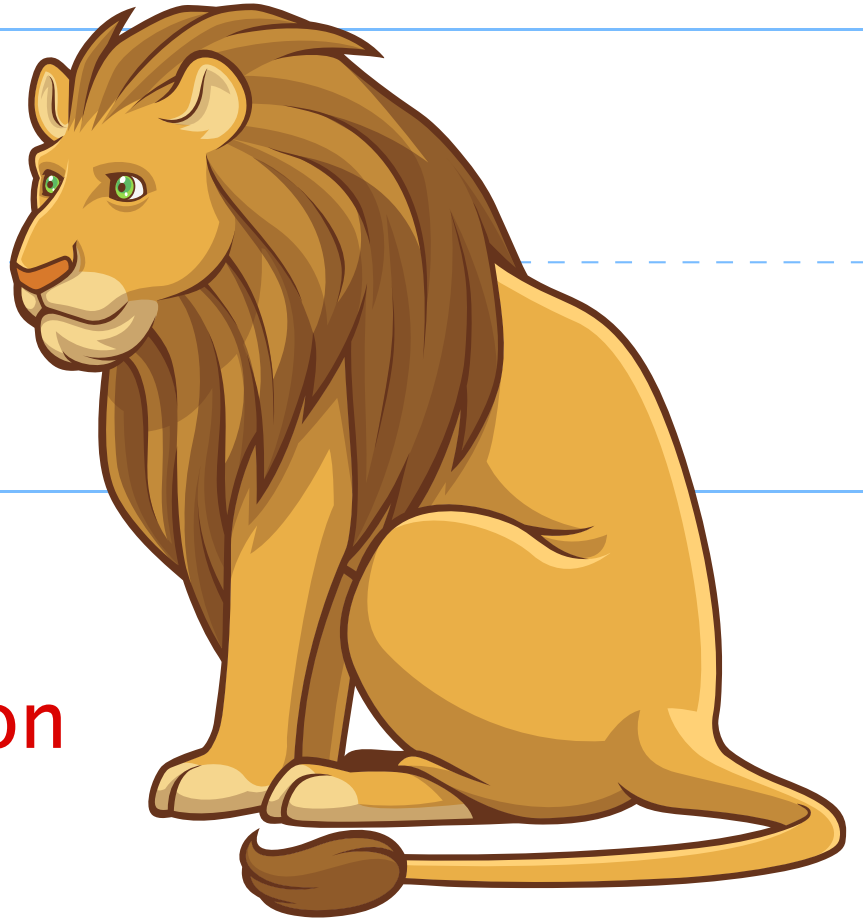
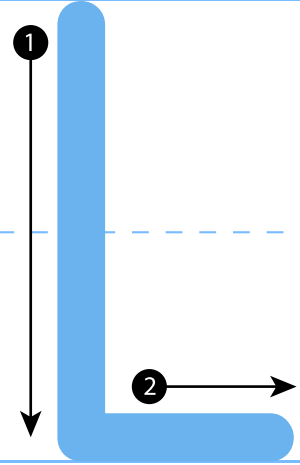

L is for Lion

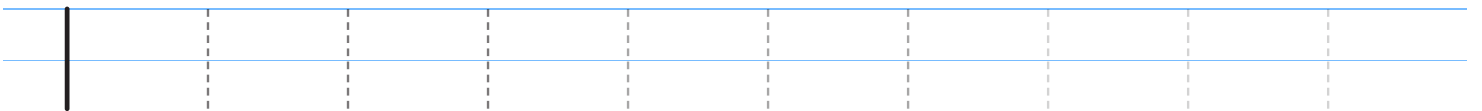

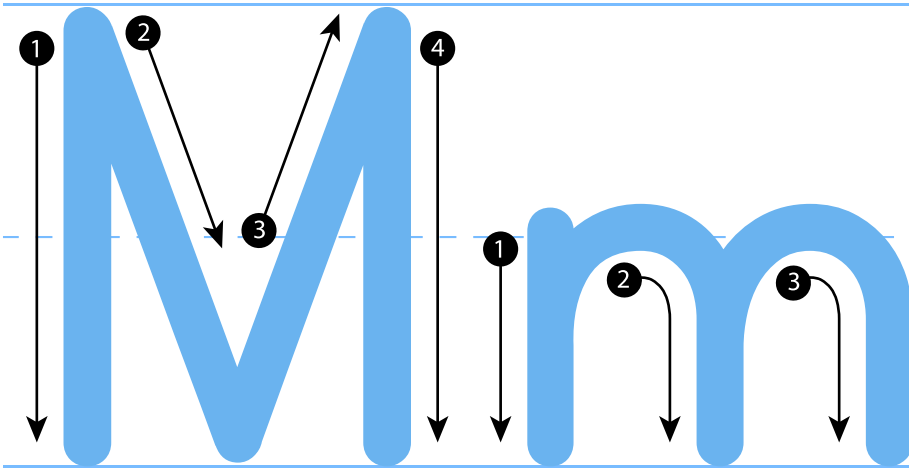

M is for Mouse



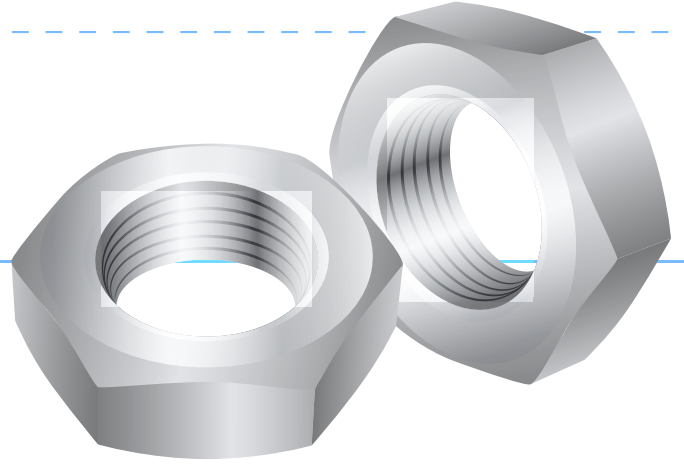
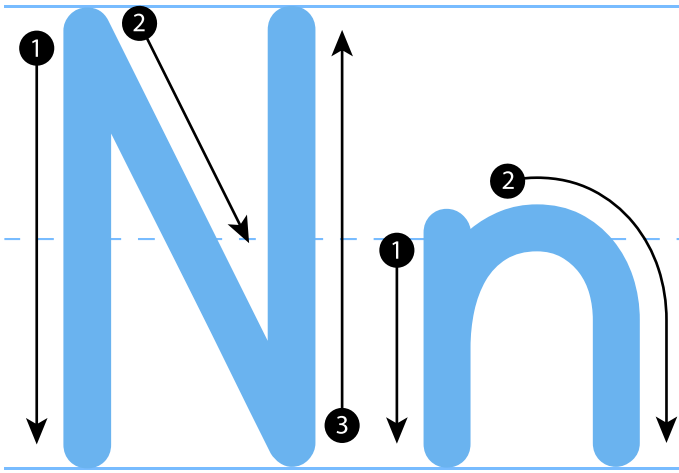

N is for Nut

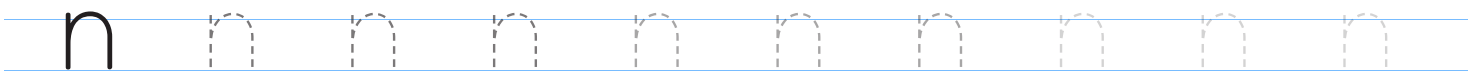
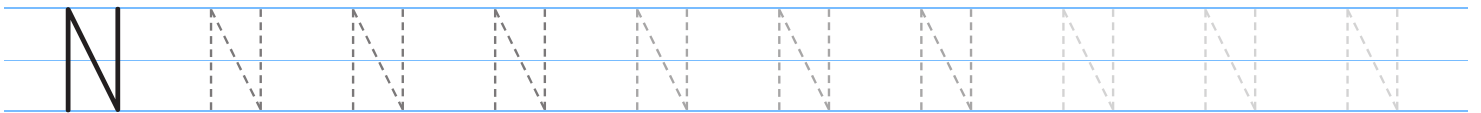

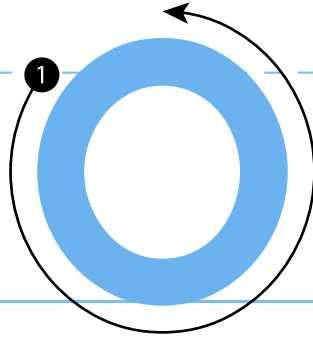
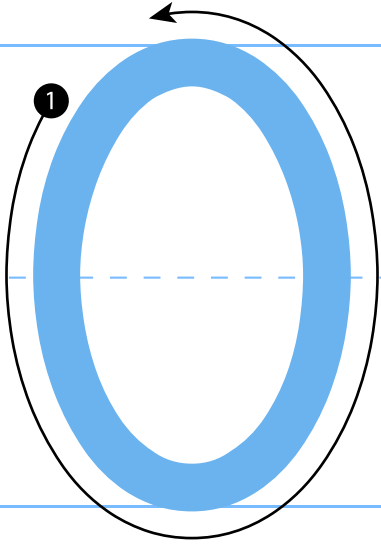

O is for Owl

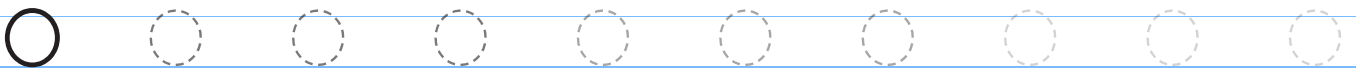
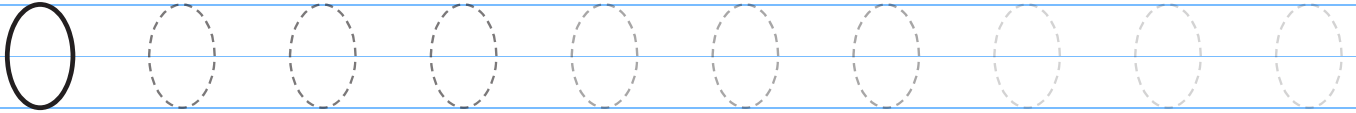

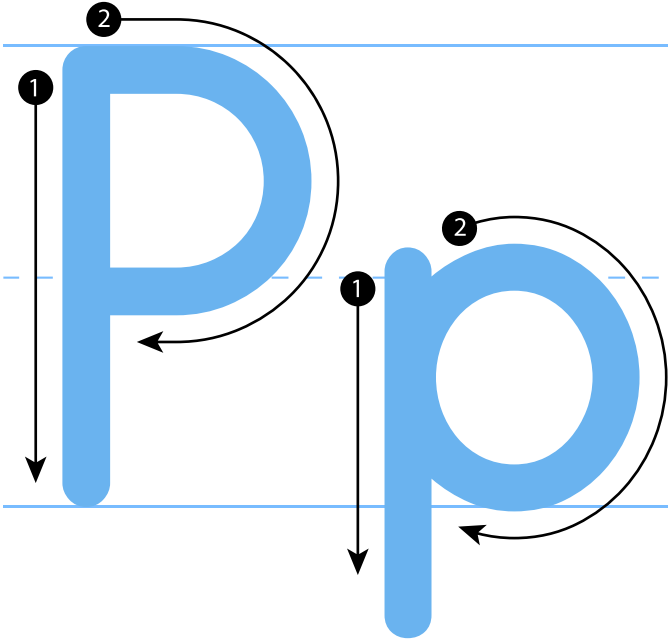

P is for Panda



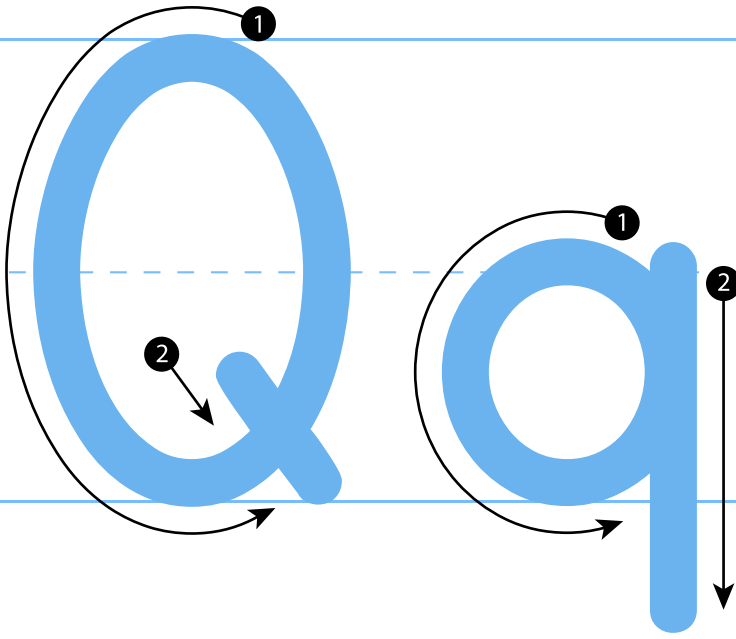

Q is for Queen

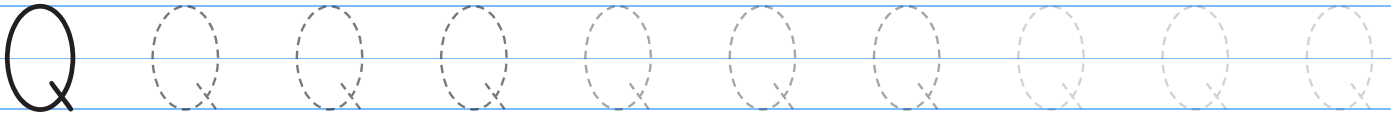

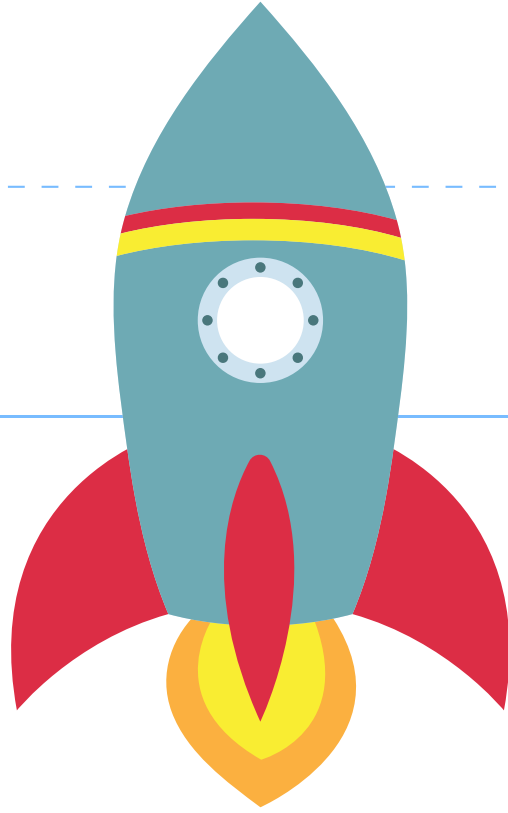
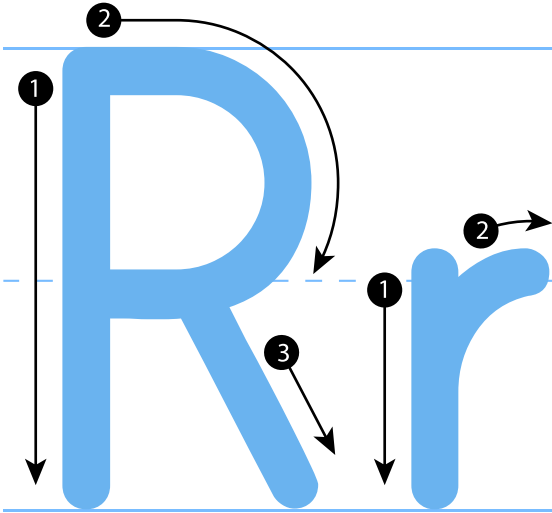

R is for Rocket

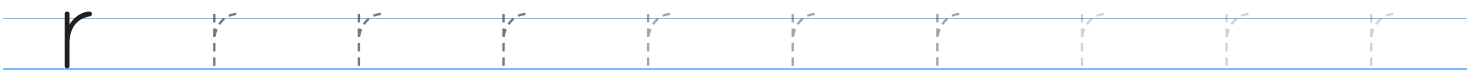

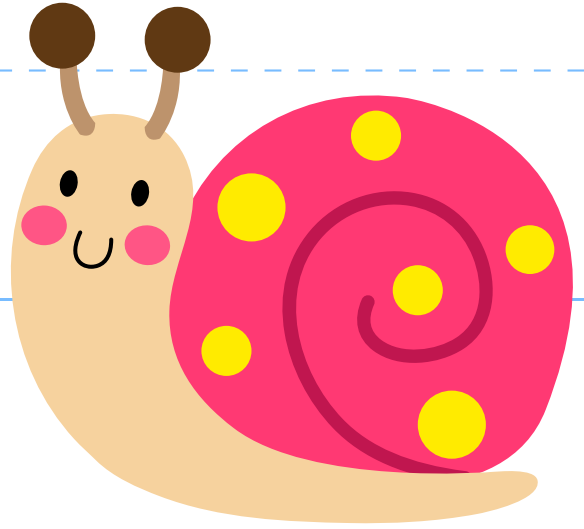
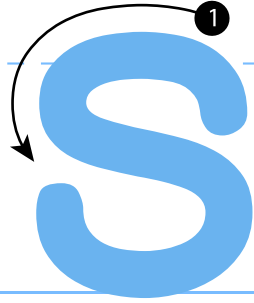
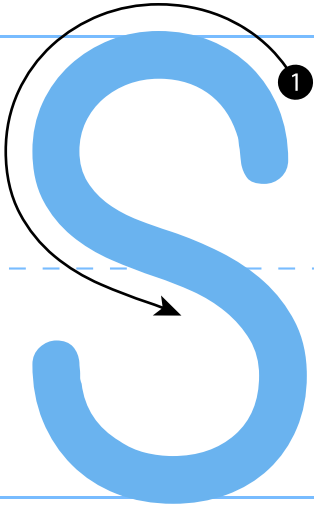

S is for Snail

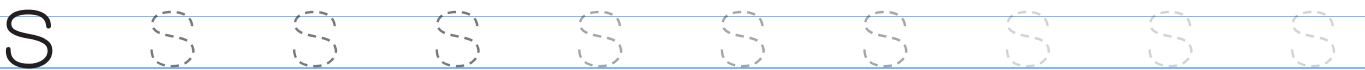
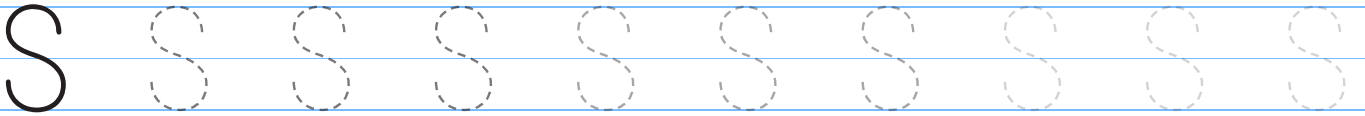

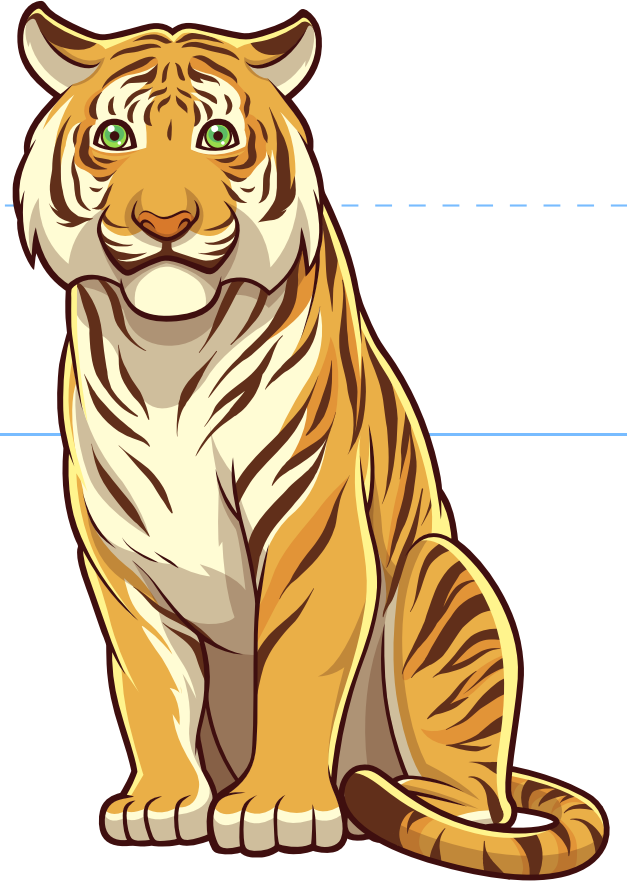
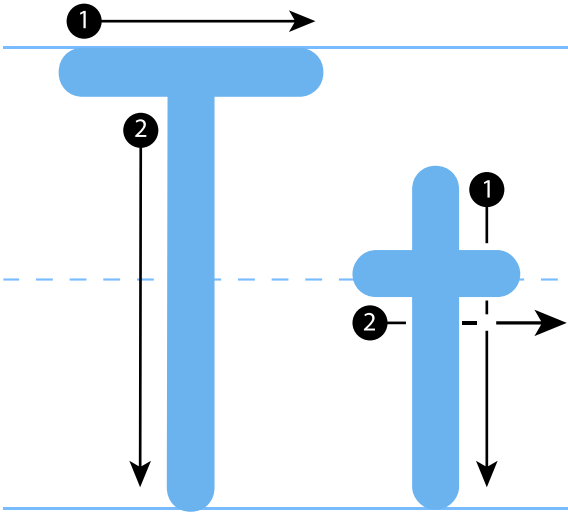

T is for Tiger

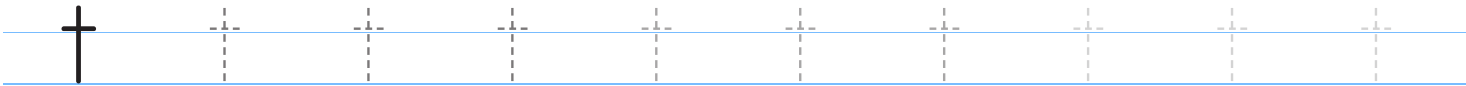

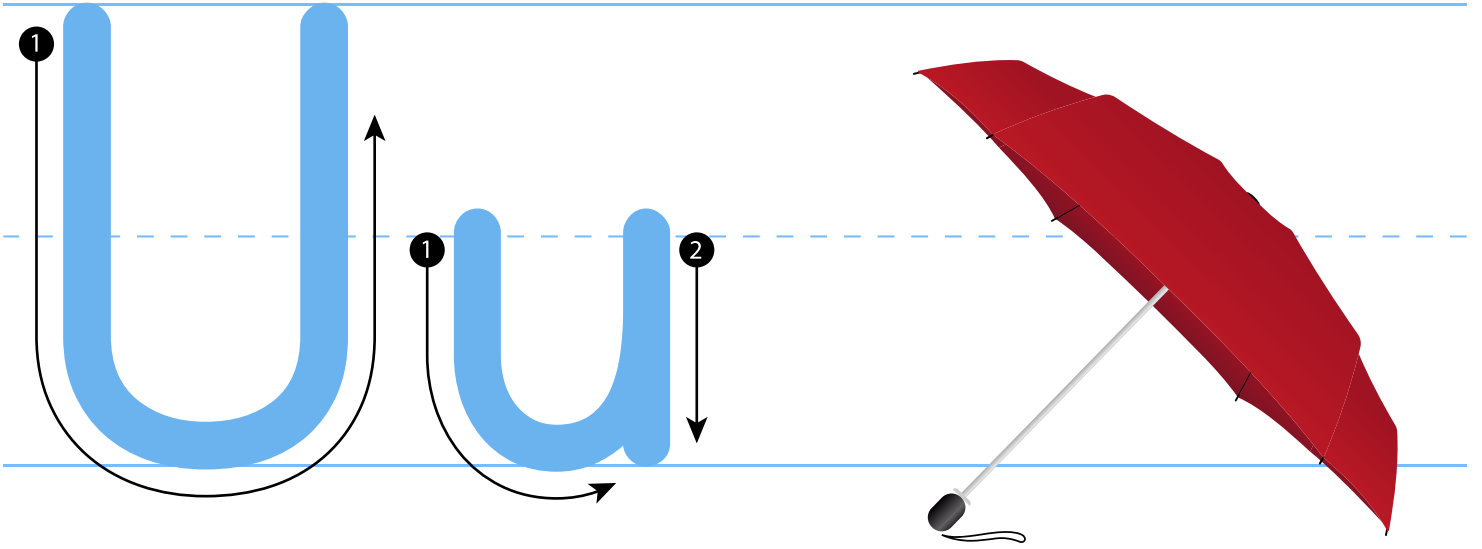

U is for Umbrella

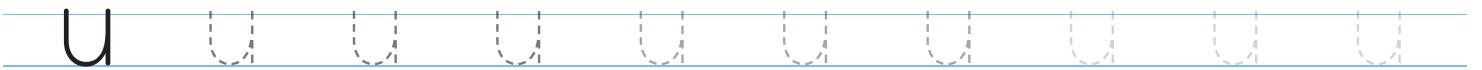
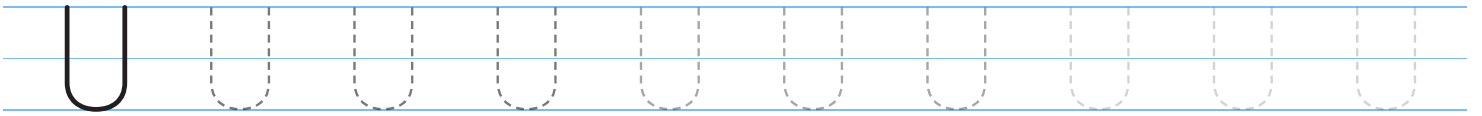

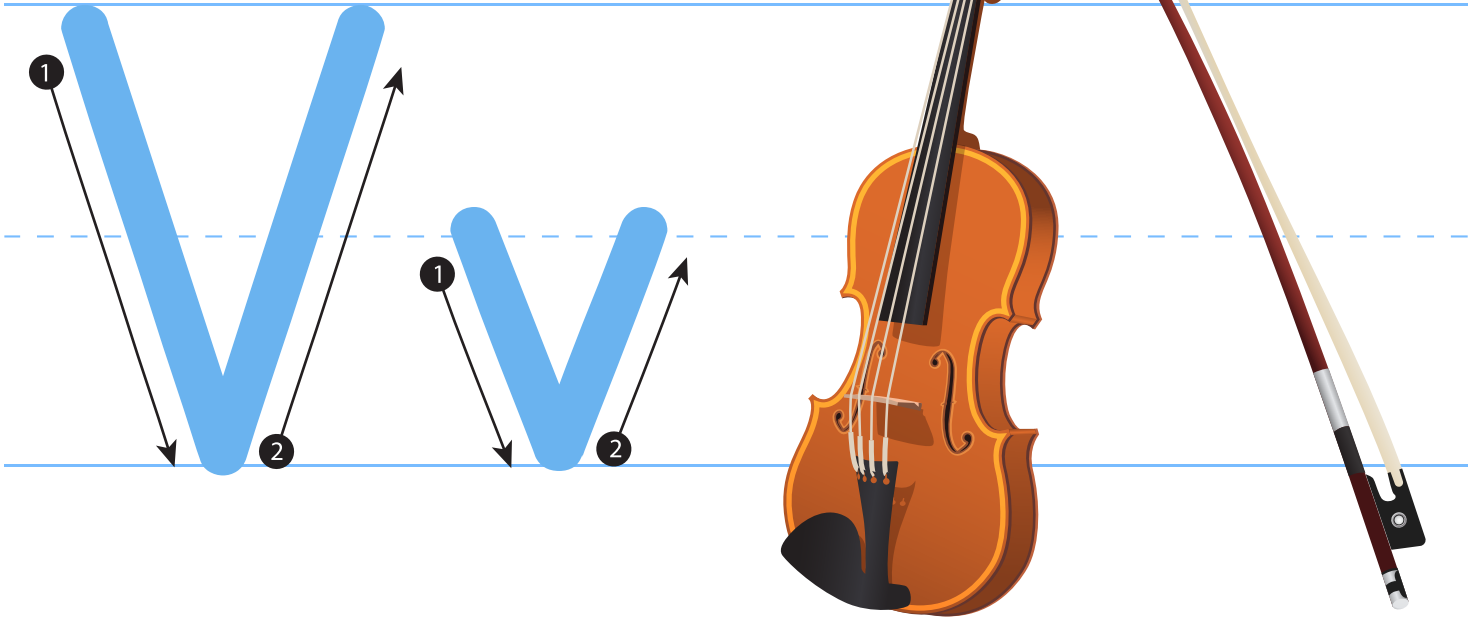

V is for violin

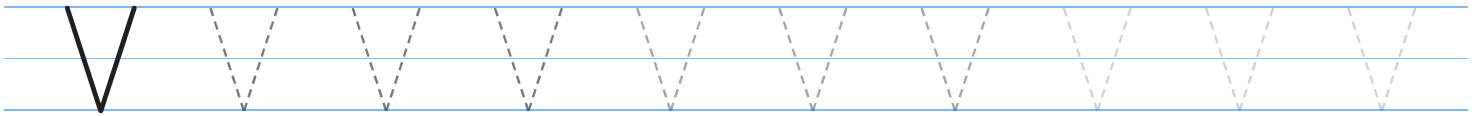

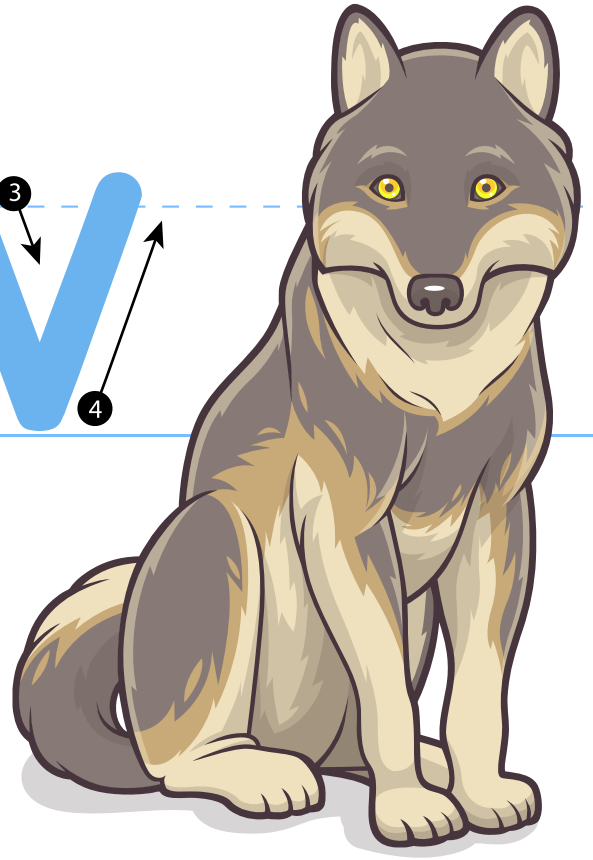
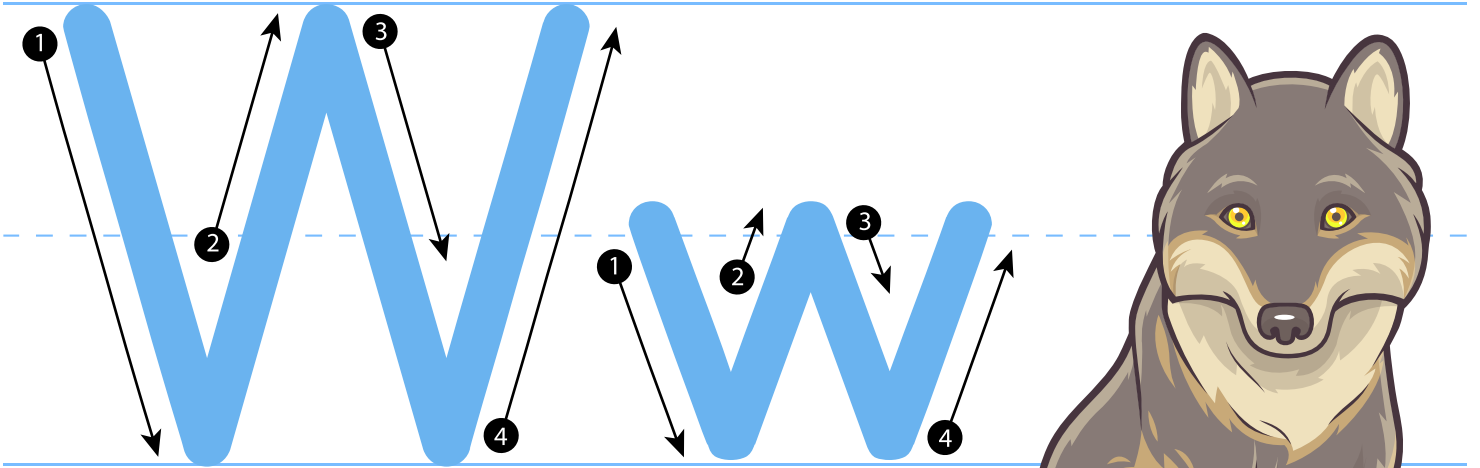

W is for wolf

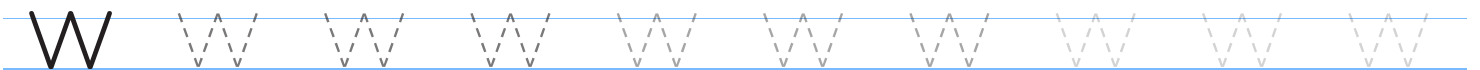
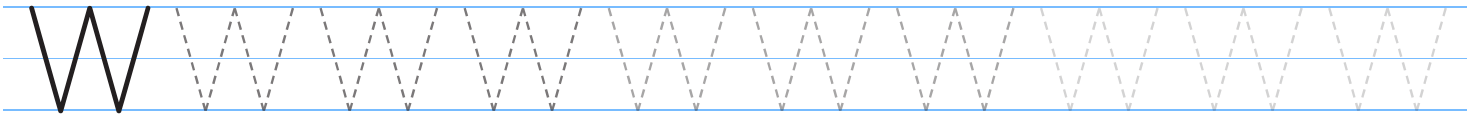

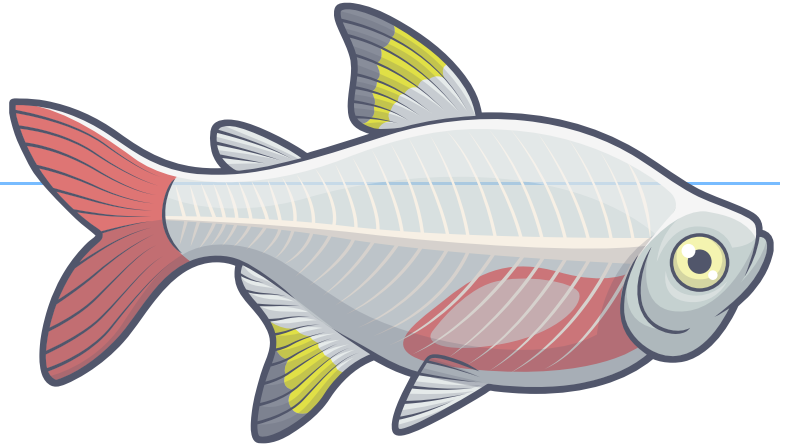
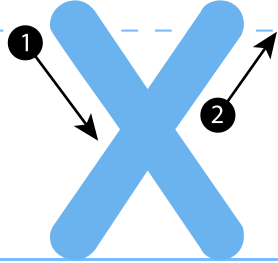
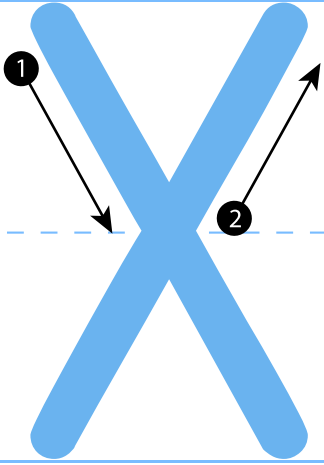

X is for X-ray Fish

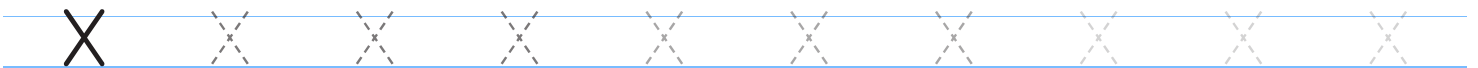

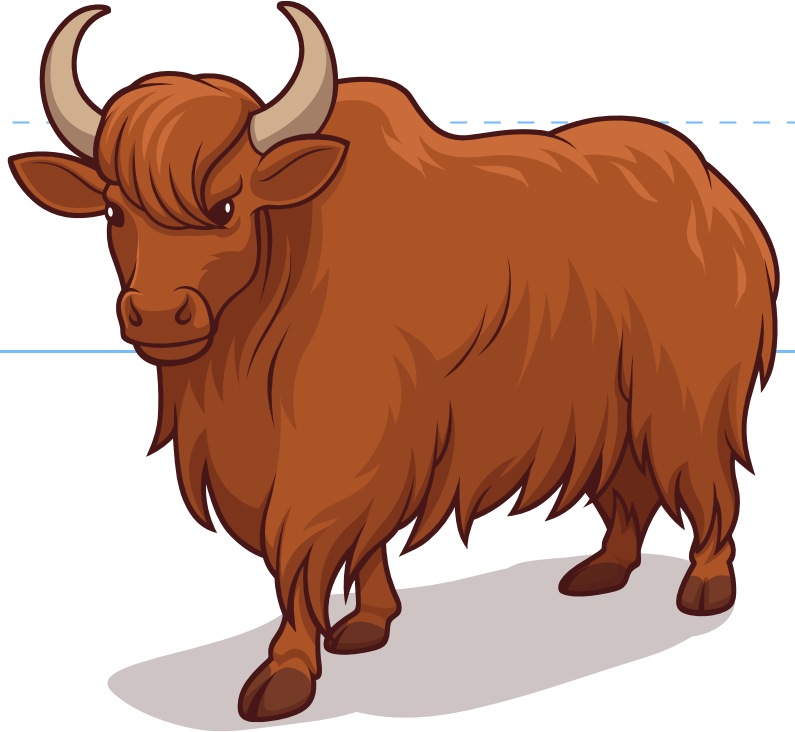
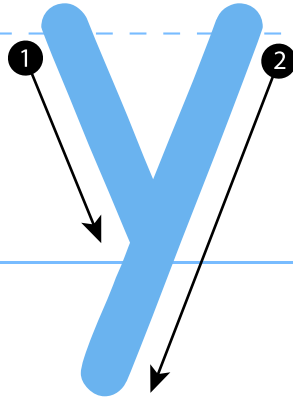
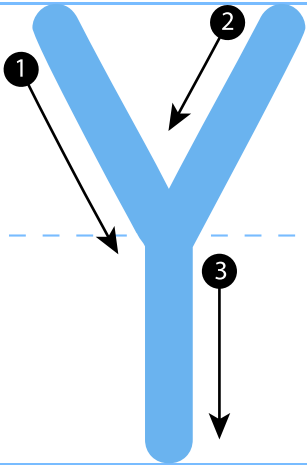

Y is for Yak



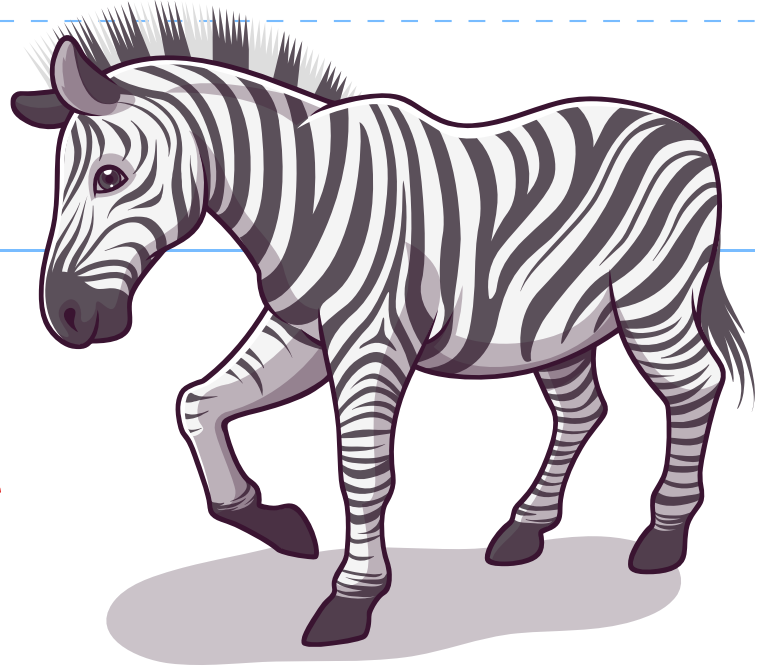
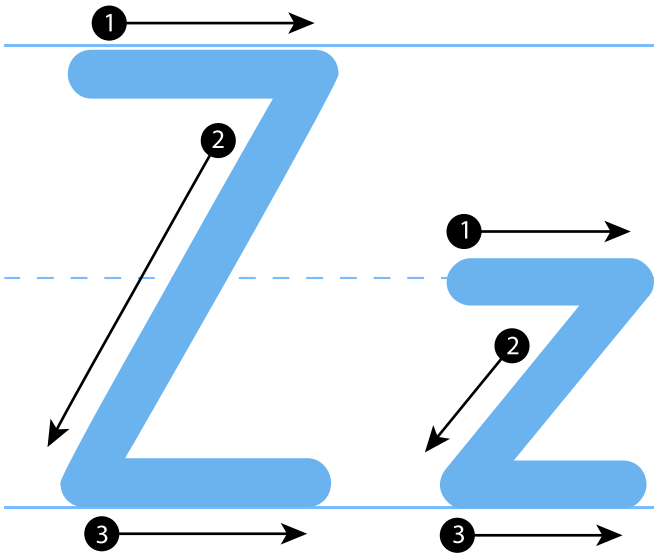

Z is for Zebra

