

Aa



A A A A A A A

a a a a a a a a a a a

Aa Aa Aa Aa Aa

Aa

apple apple apple apple

apple

# Aa



## 1-Colour and say:

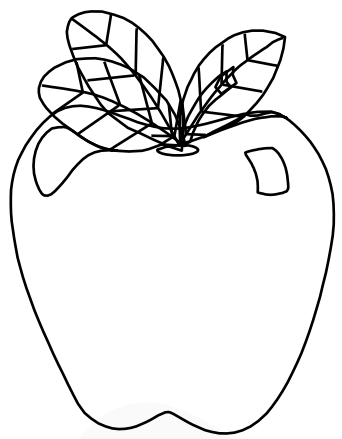

Apple

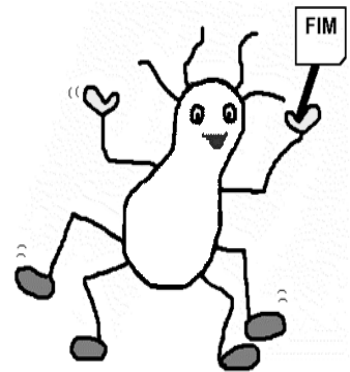

Ant

### FUN ZONE

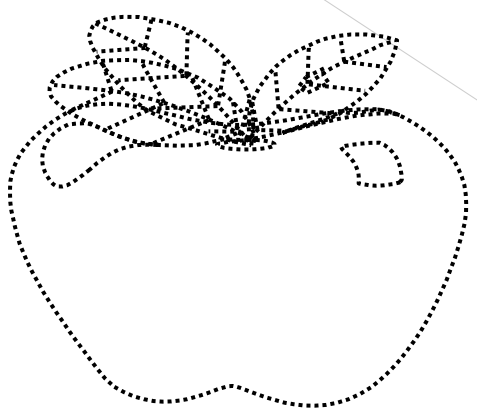

Apple

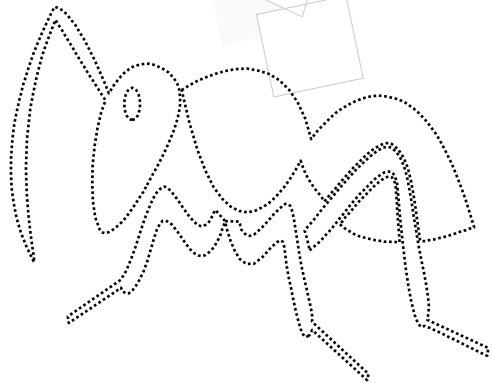

Ant

# Aa



Bb

B B B B B B B B

b b b b b b b b b b

Bb Bb Bb Bb Bb Bb

Bb

ball ball ball ball ball

ball

# Bb



## 2-Colour and say:



book

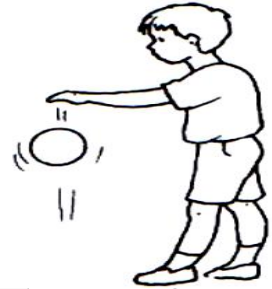
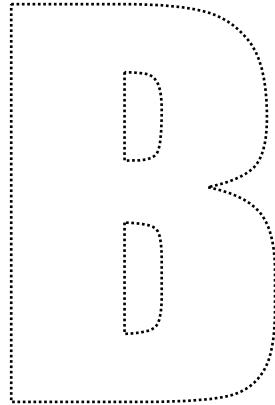

boy

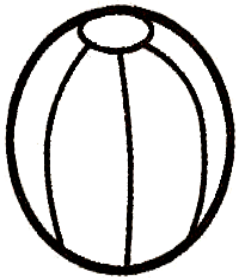

ball

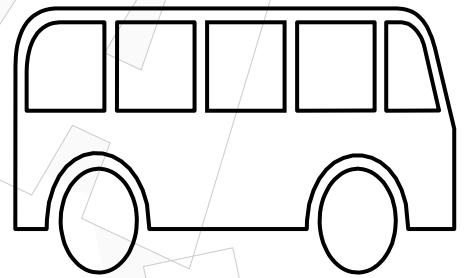
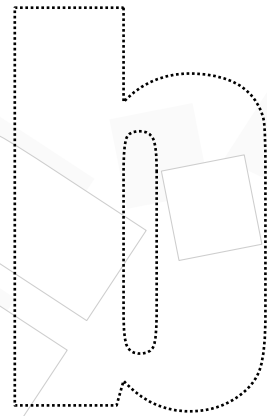

bus

### FUN ZONE

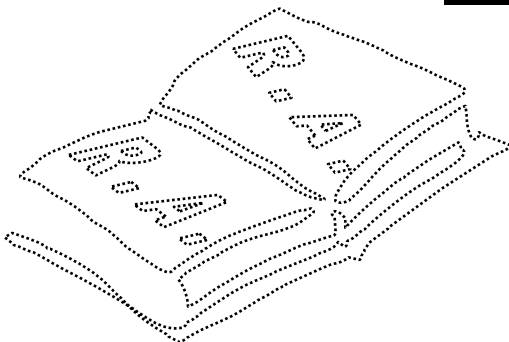

book

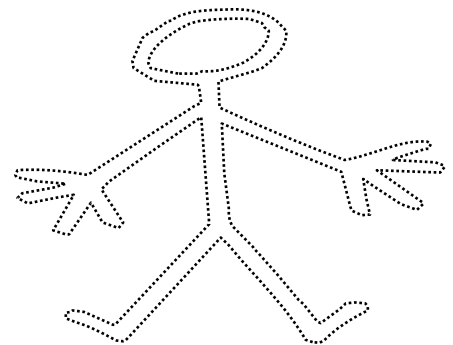

body

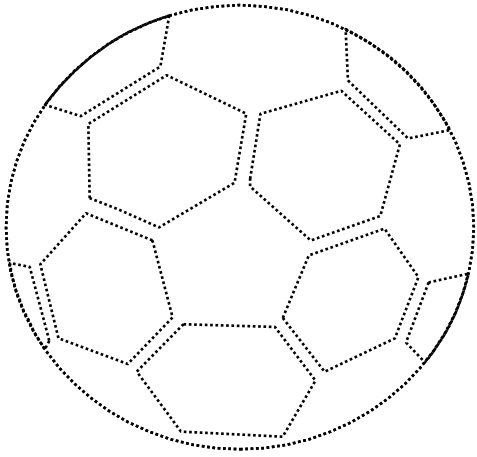

ball

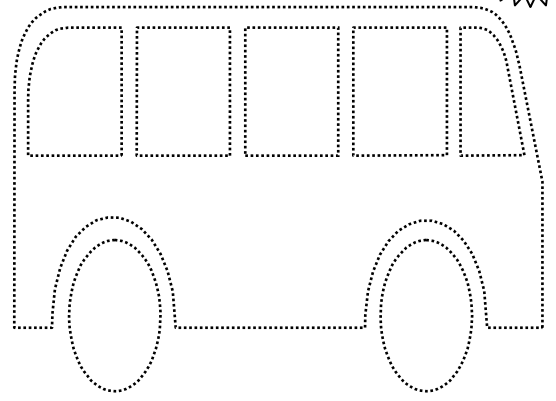

bus

**1-Match the words with the pictures:**

1- ball

2- apple

3- ant

4- book

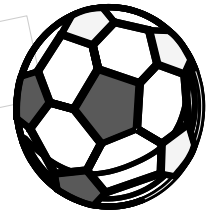
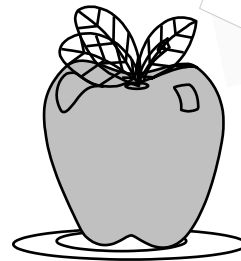
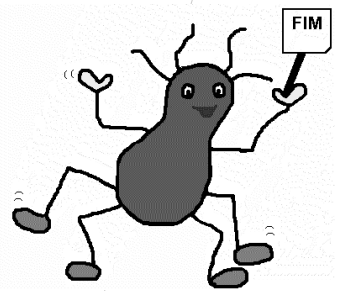

**2-Write the first letter under each picture :**

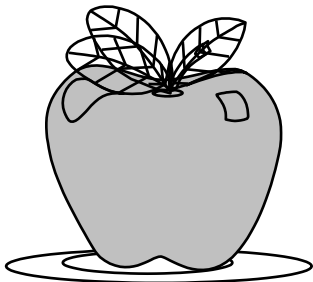

.....



.....

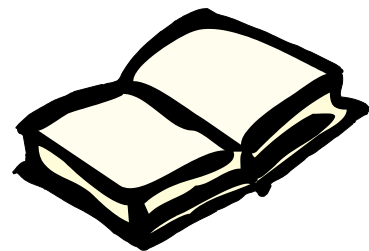

.....

Cc



C C C C C C C C

c c c c c c c c c c c c

Cc Cc Cc Cc Cc Cc

Cc

cat cat cat cat cat cat

cat

# Cc

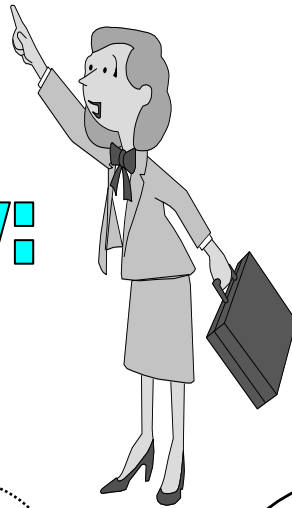

## 3-Colour and say:

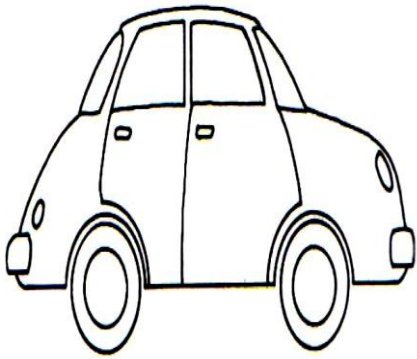

car

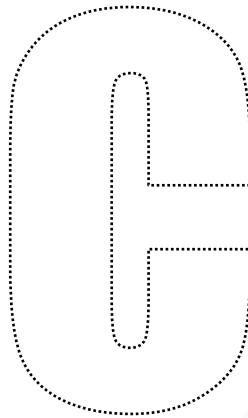

cat

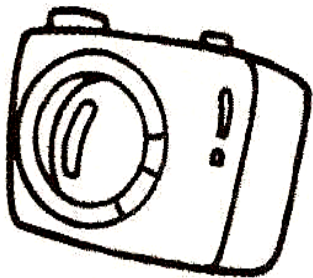

camera



carrot

### FUN ZONE

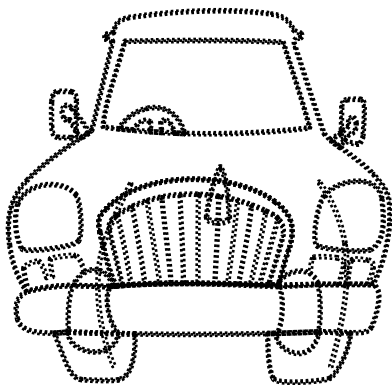

car

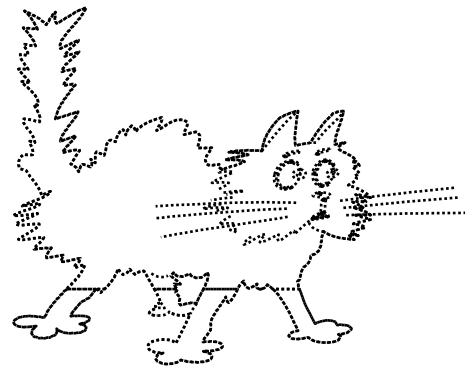

cat

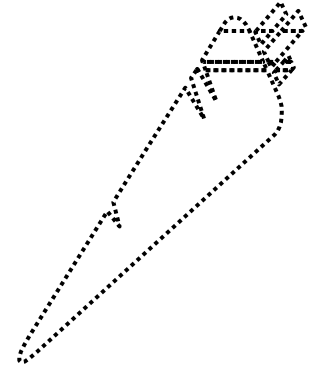
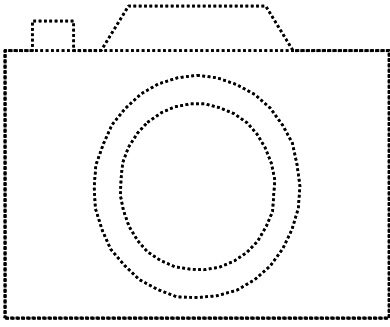

camera

carrot

**1-Match the words with the pictures:**

1- car

2- cat

3- camera

4- boy

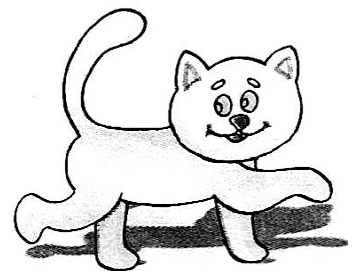
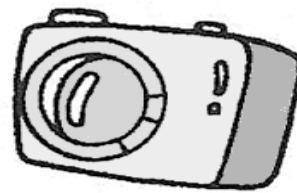



Dd



D D D D D D D

d d d d d d d d d d

Dd Dd Dd Dd Dd Dd

Dd

duck duck duck duck

duck

# Dd



## 4-Colour and say:

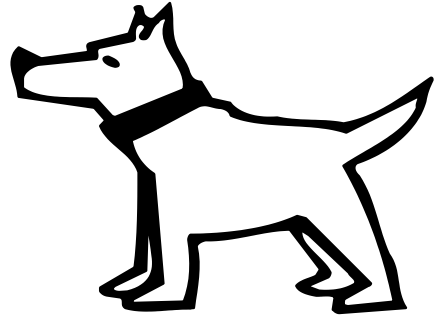

dog

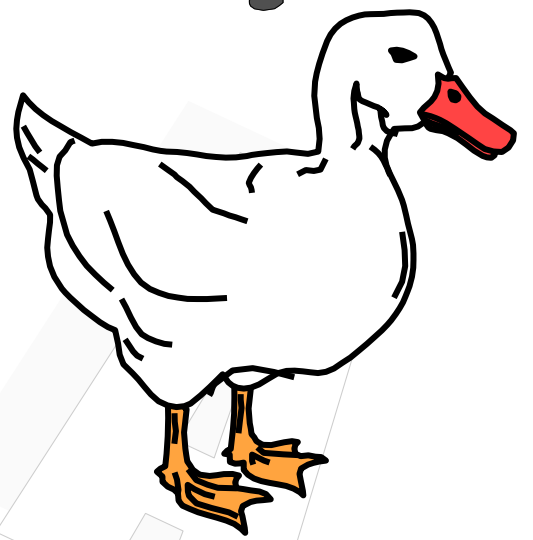
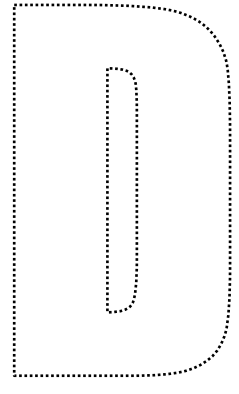

duck

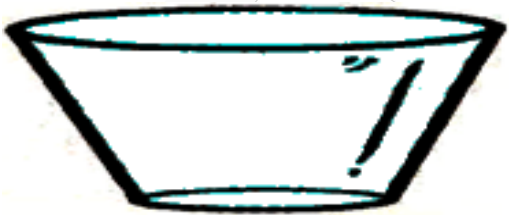

dish

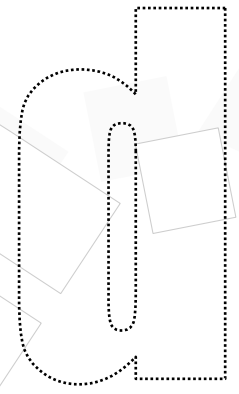

### FUN ZONE

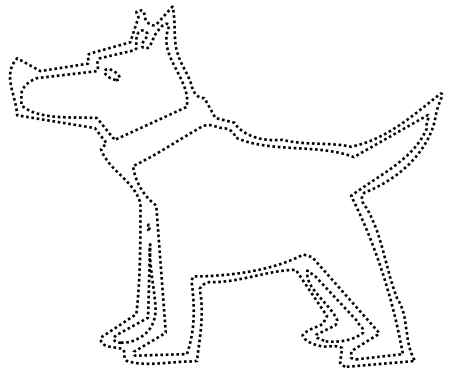

dog

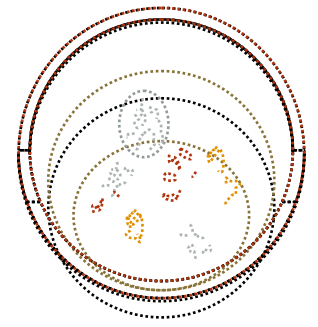

dish

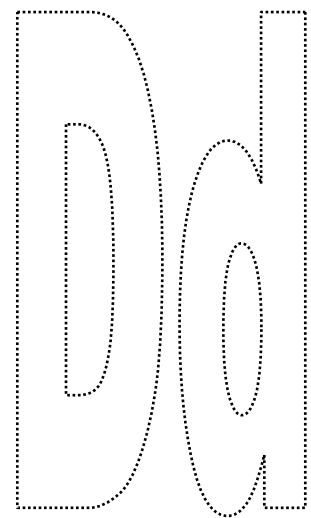
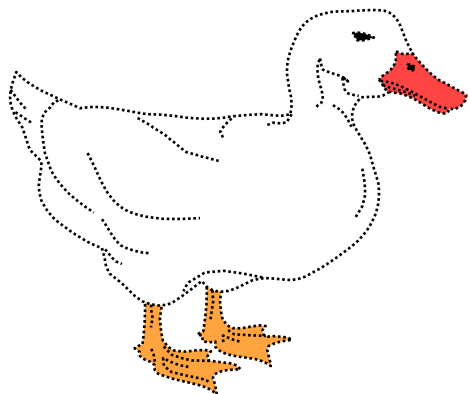

duck

**1 -Write the first letter under each picture :**

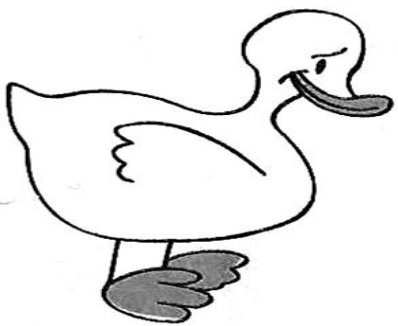
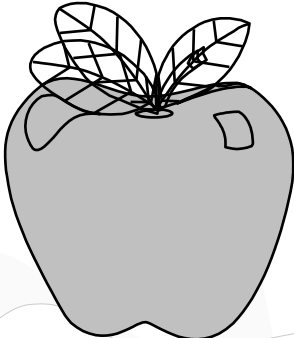

.....

.....

.....

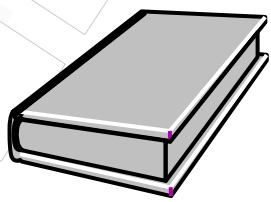

.....

.....

.....

**2 -Write the capital letters for the following small letters :**

a

b

c

d

.....

.....

.....

.....

Ee

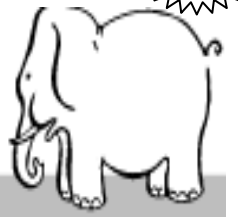

E E (with stroke order arrows) E E E E E E E E

e e (with stroke order arrows) e e e e e e e e e e

Ee Ee Ee Ee Ee Ee Ee Ee

Ee Ee Ee Ee Ee Ee Ee Ee

elephant elephant (dotted) elephant

elephant elephant

# Ee



## 4-Colour and say:

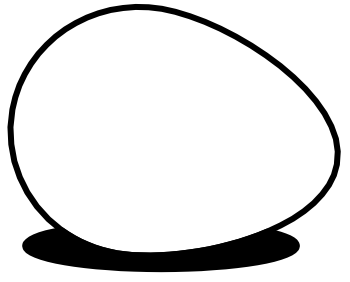

egg

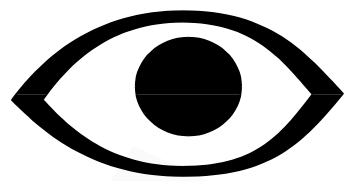
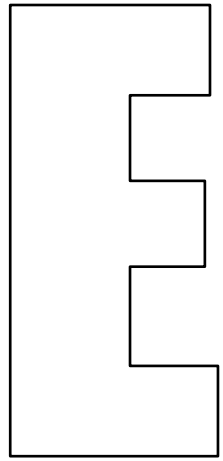

eye

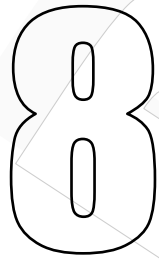

eight

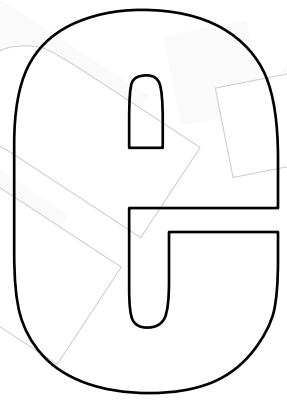

elephant

### FUN ZONE

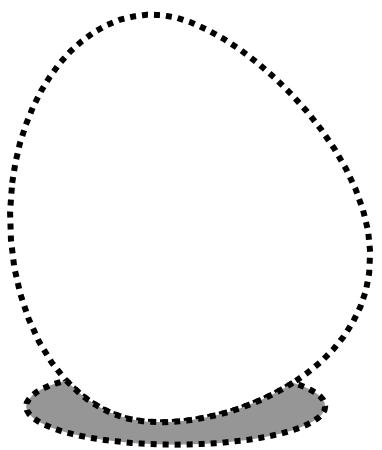

egg

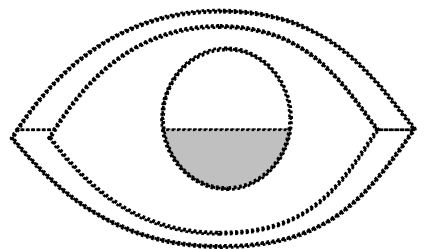

eye

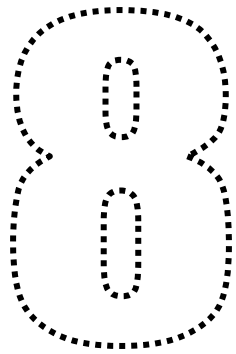

eight

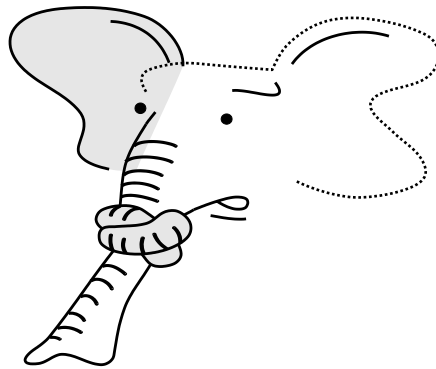

elephant

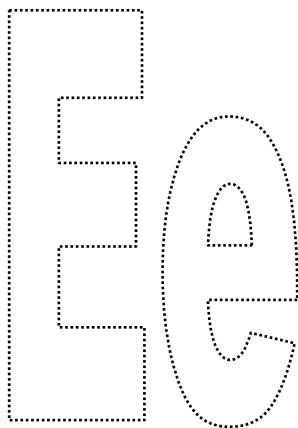

**1 -Write the small letters for the following capital letters :**

**A**

**B**

**C**

**D**

**E**

**2- Circle the different picture:**

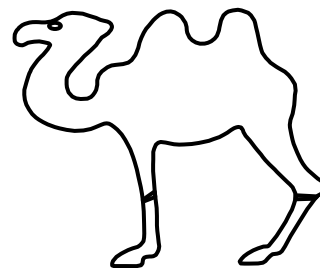



Ff

F F (with stroke order arrows) F F F F F F F F

f f (with stroke order arrows) f f f f f f f f

Ff Ff Ff Ff Ff Ff Ff

Ff Ff Ff Ff Ff Ff Ff

fish fish fish fish fish fish fish

fish fish fish fish fish fish fish

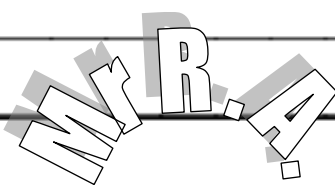

Ff



6-Colour and say:

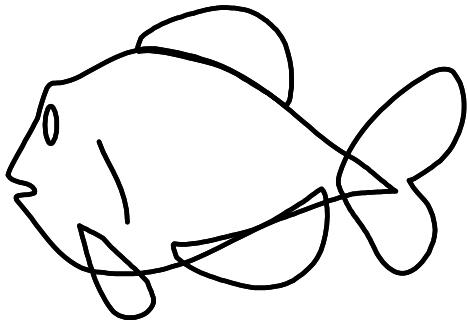

F

5

fish

f

five

**FUN ZONE**

5

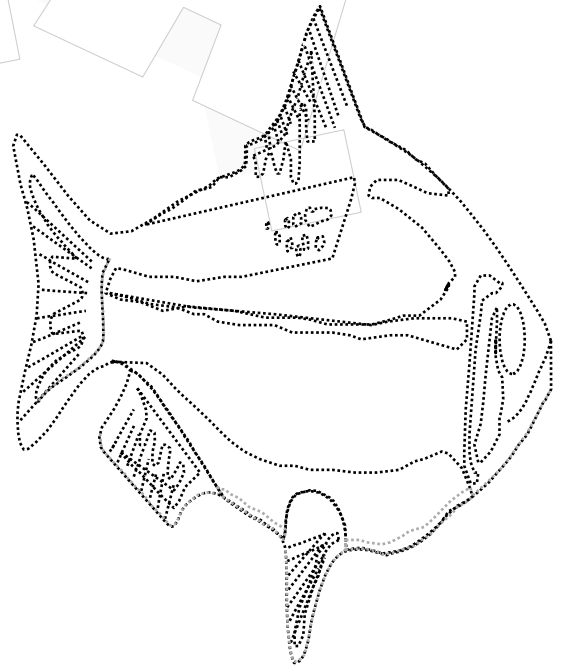

five

fish



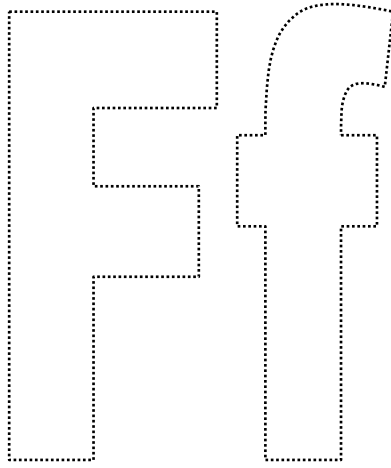

**1- Complete the following letters :**

**Aa**

...b

**Cc**

**D...**

**E...**

...f

**2- Listen and circle the right picture :**

1.

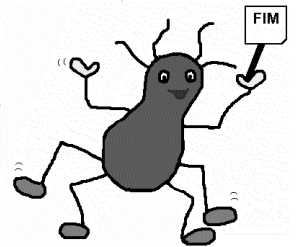
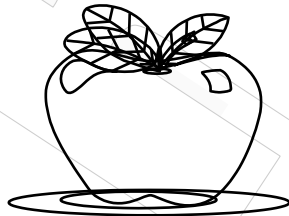

2.

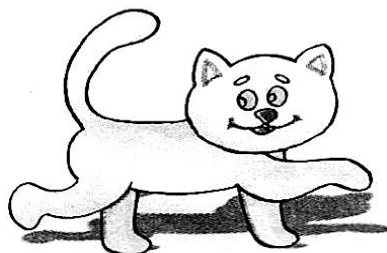
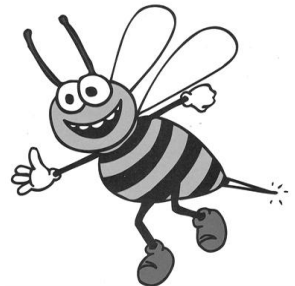

Gg



Gg

G G G G G G G

g g g g g g g g g g

Gg Gg Gg Gg

Gg

grapes grapes grapes

grapes

# Gg



## 7-Colour and say:

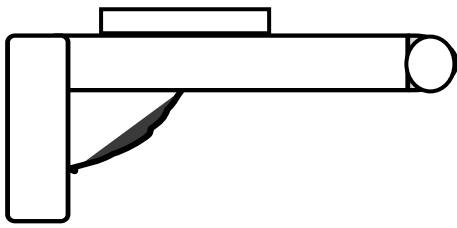

gun



girl

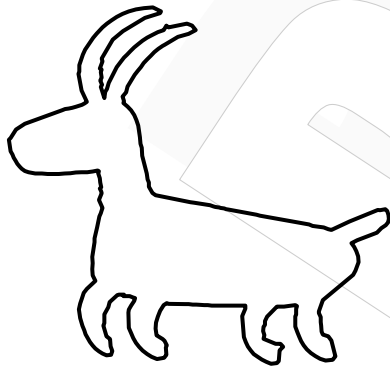

goat

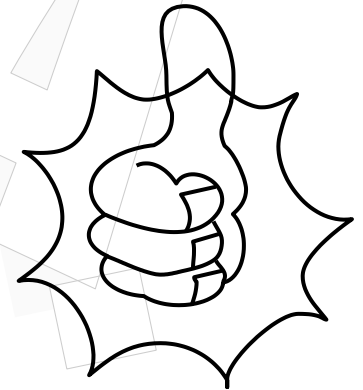
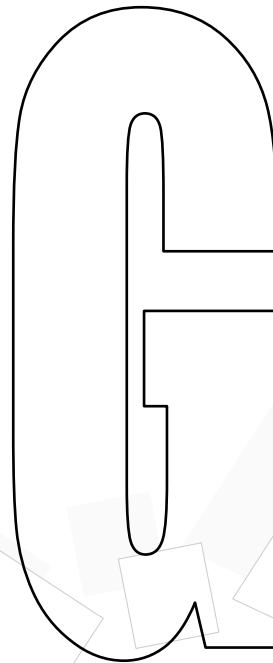

Good.



Goodbye.

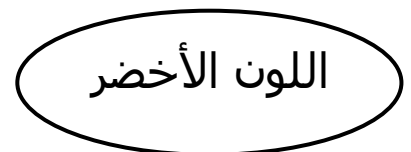
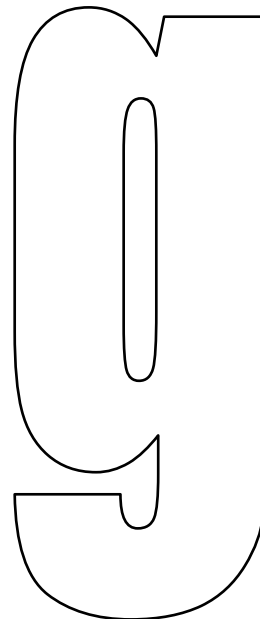

green

# Fun Zone

## 1-Match and colour :

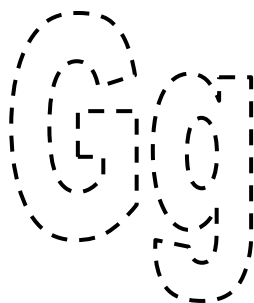
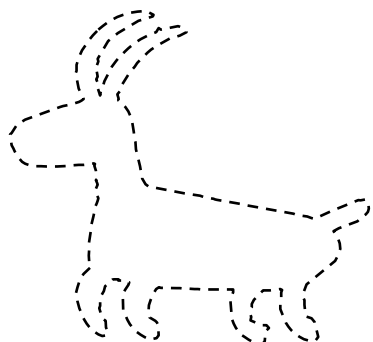

## 2-Match the words with the pictures:

1- Goodbye

2- G

3- good

4- gun

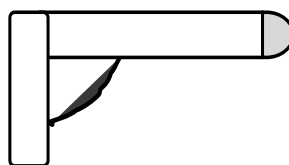
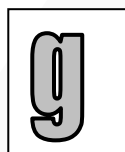

## 3-Write the first letter under each picture:

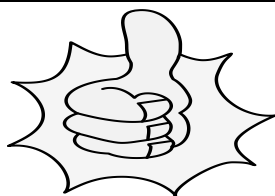
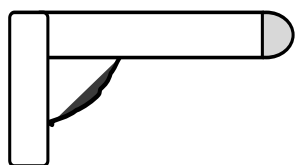

.....

.....

.....

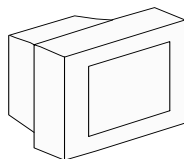

.....

.....

.....



# Hh



## 8-Colour and say:

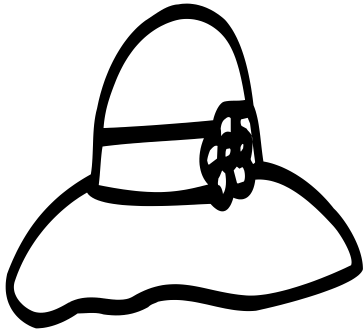

hat

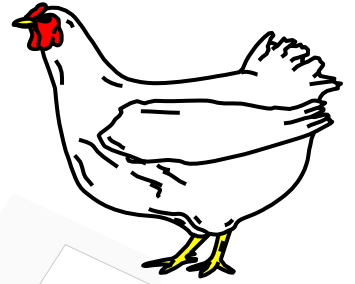
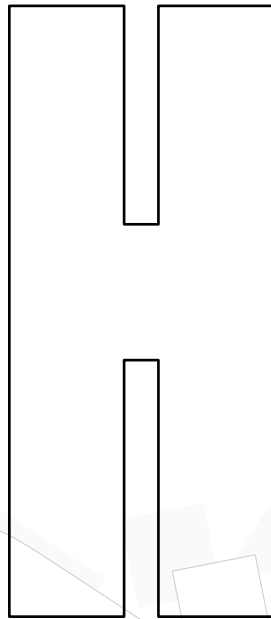

hen



hand

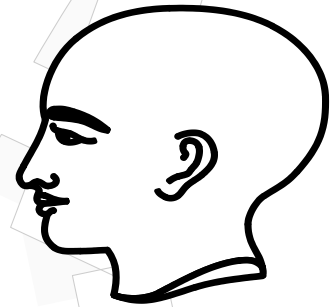

head

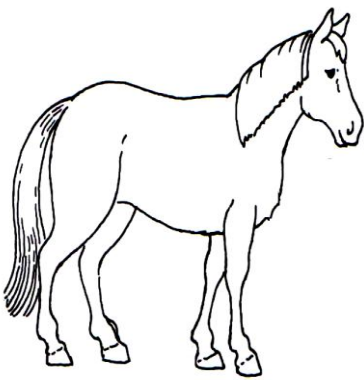

horse

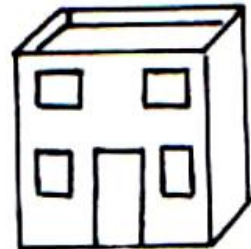
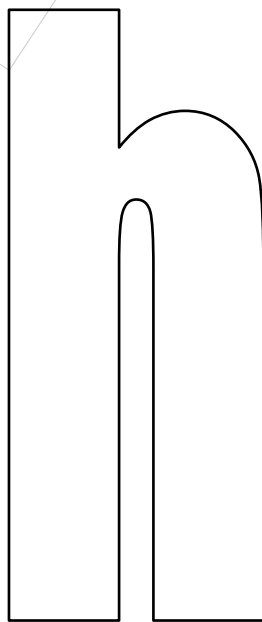





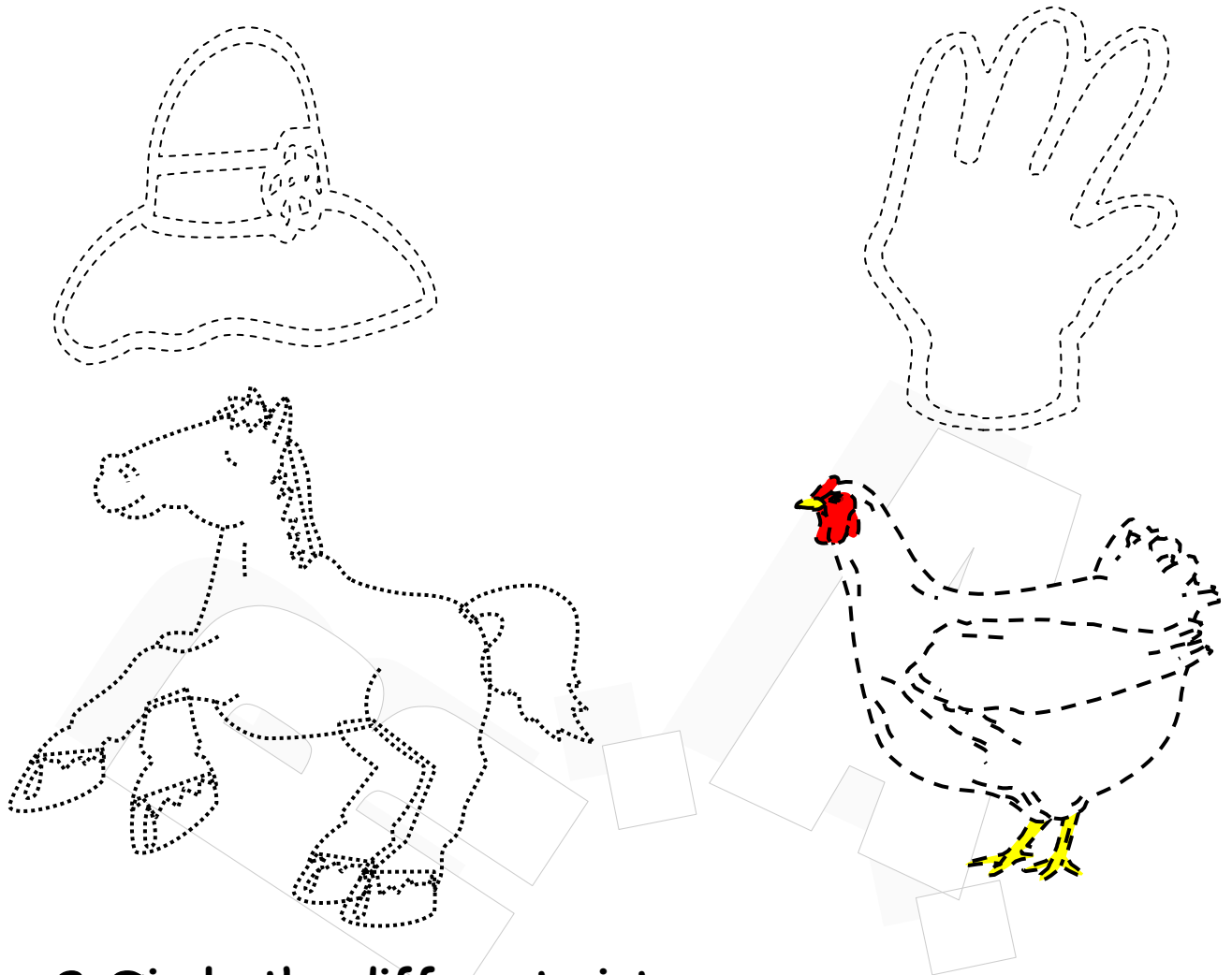

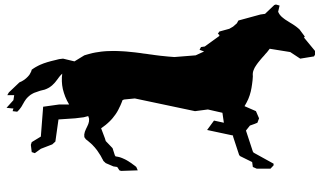

house

## 1-Match and colour :

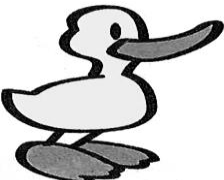

## 2- Circle the different picture:

1-			
2-			
3-			





Ii

9-Colour and say:



I



ice-cream

i

I

1-Supply the missing letters :

1- ice crea.....

2- appl.....

3- c..t

4- bo.....

5- han.....

6- hors...

2-Match the words with the pictures :

1- car

2- ball

3- I

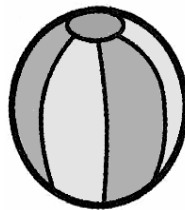

Jj

Jj



J J J J J J J

j j j j j j j j j j j j j j j j

Jj Jj Jj Jj Jj Jj

Jj

jet jet jet jet jet jet jet

jet

Jj



# 10-Colour and say:



J



jacket

J

jump

## 1-Match the words with the pictures :

1-jump

2-egg

3-hen

4-duck

5- one

6-two

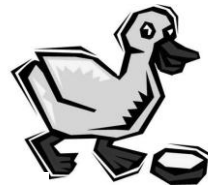

1

2

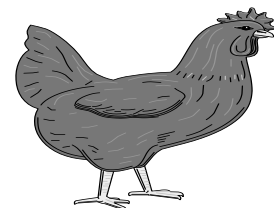

Kk

Kk



Kk Kk Kk Kk Kk Kk Kk Kk

k k k k k k k k k k k k

Kk Kk Kk Kk Kk Kk Kk Kk

Kk

kite kite kite kite kite

kite

# Kk



## 11-Colour and say:

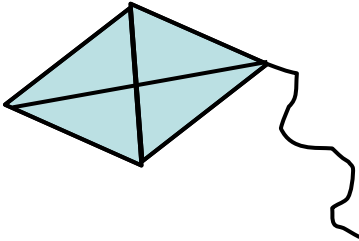

# K

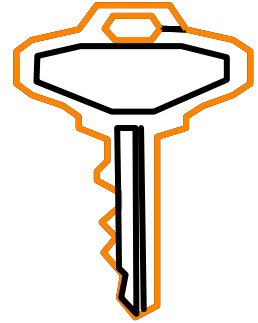

# kite

# k

# key

### Fun Zone

1-Match and colour :

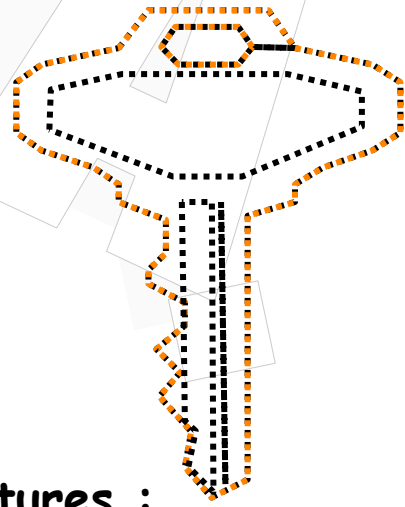
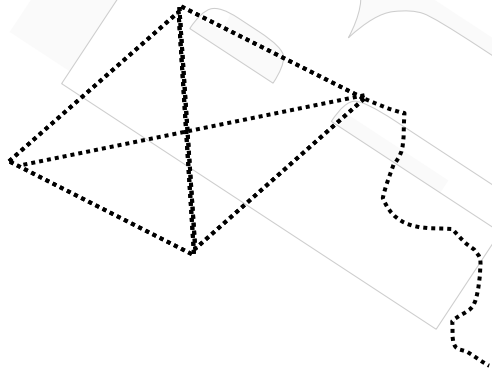

2-Match the words with the pictures :

1-key

2-kite

3-elephant

4-hat

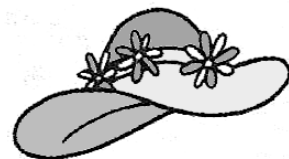
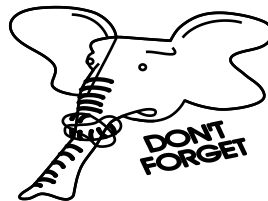
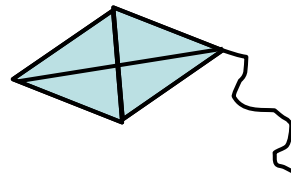

L l

L l



L l L l L l L l L l L l L l

L l L l L l L l L l L l L l L l L l L l L l L l L l

L l L l L l L l L l L l L l L l L l L l L l L l L l

L l L l L l L l L l L l L l L l L l L l L l L l L l

lemon lemon lemon

lemon

LI  
12-Colour and say:



lion

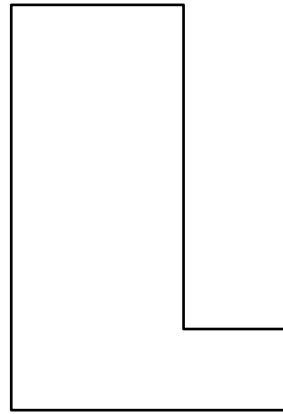

lollipop

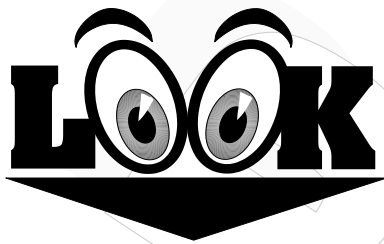

LOOK.

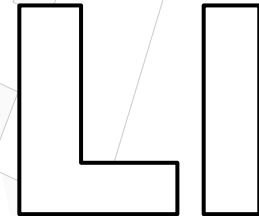
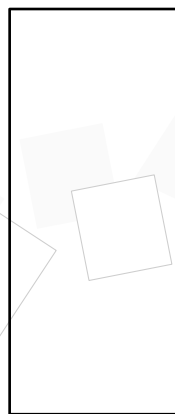

1-Match the words with the pictures :

1- look

2- lion

3- lollipop

4- kite

5-jacket

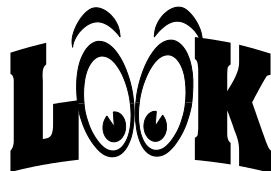

Mm



Mm

M M M M M M M M M M

m m m m m m m m m m

Mm Mm Mm Mm

Mm

mouse mouse mouse

mouse



# Mm



## 13-Colour and say:

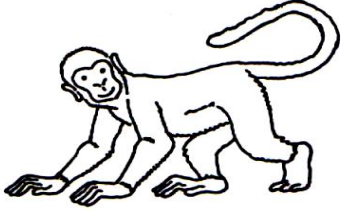

monkey

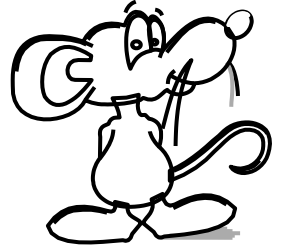
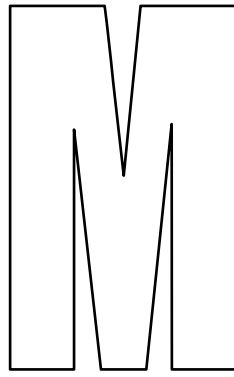

mouse



mother

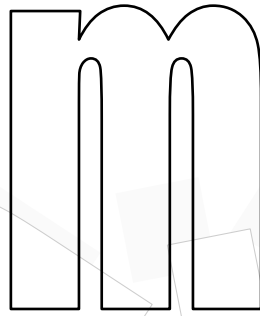

mat

### Fun Zone

1-Match and colour :

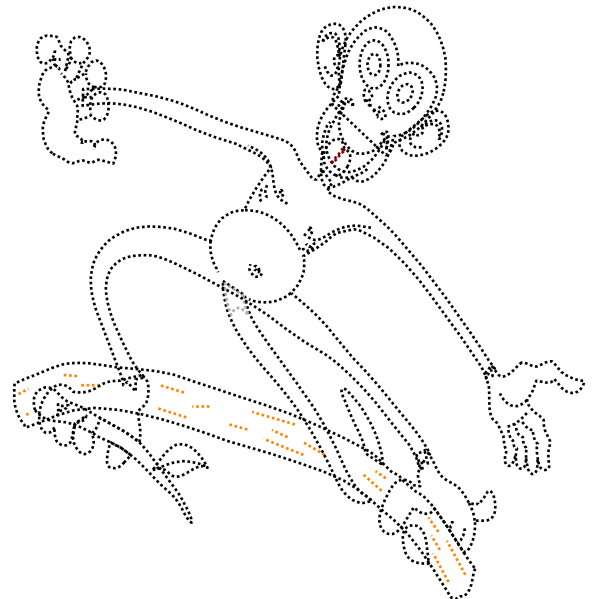
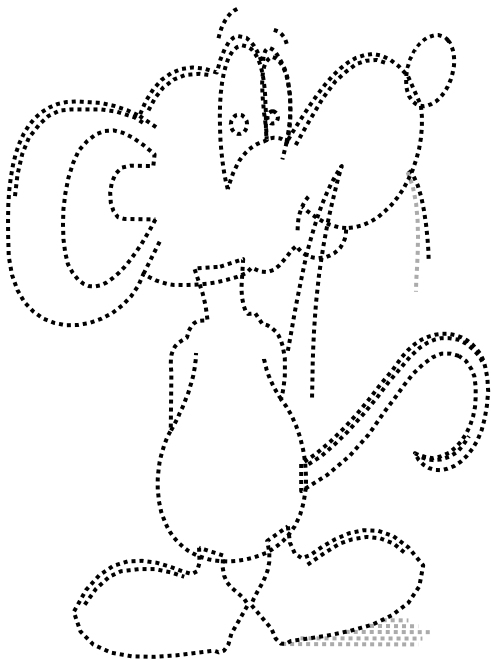

**2-Match the words with the pictures:**

1-man

2-mother

3-mat

4-moon

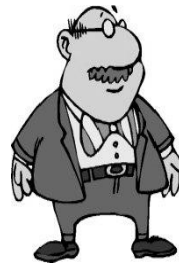

**3- Write the words under each picture:**

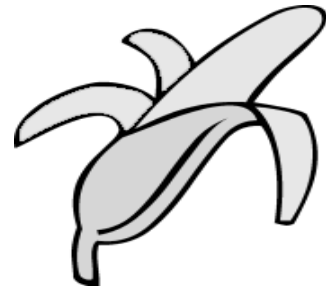
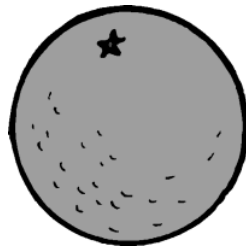
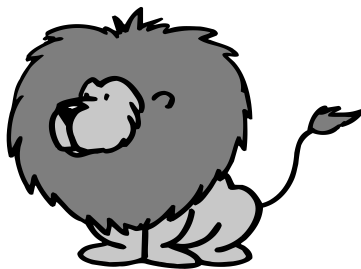
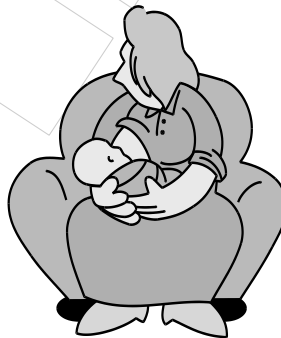
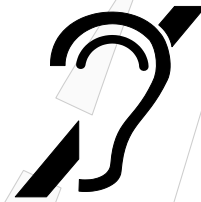

Nn

Nn



N N N N N N N N N N N N N N N N

n n n n n n n n n n n n n n n n

Nn Nn Nn Nn Nn Nn Nn

Nn

nest nest nest nest

nest

# Nn

## 14-Colour and say:



9  
nine

N

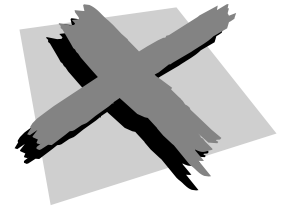

No

nose

n

Nn

1-Match the words with the pictures :

1-nose

2-No

3- nine

4-fish

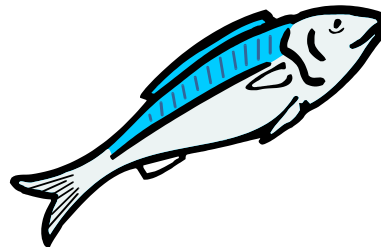

9

Oo



Oo

O O O O O O O

o o o o o o o o o o

Oo Oo Oo Oo

Oo

octopus octopus

octopus

Oo



# 15-Colour and say:

1

O

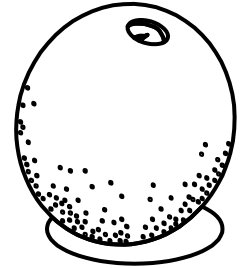

one

O

orange

## Fun Zone

1-Match and colour :

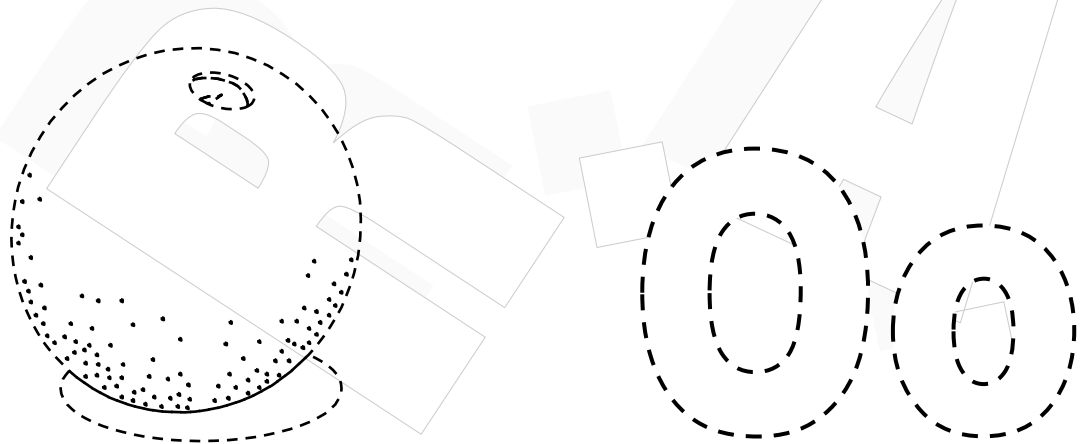

2-Match the words with the pictures :

1-five

2-one

3-orange

4- hen



5

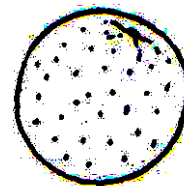

Pp



Pp

P P P P P P P P

p p p p p p p p p p

Pp Pp Pp Pp Pp Pp Pp Pp

Pp

parrot parrot parrot

parrot

# Pp



## 16-Colour and say:

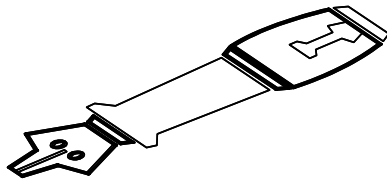

pen

# P



pencil

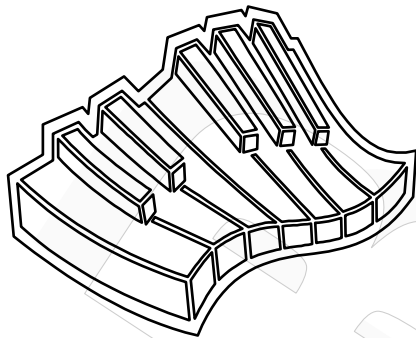

piano

# p



play

### Fun Zone

1-Match and colour :

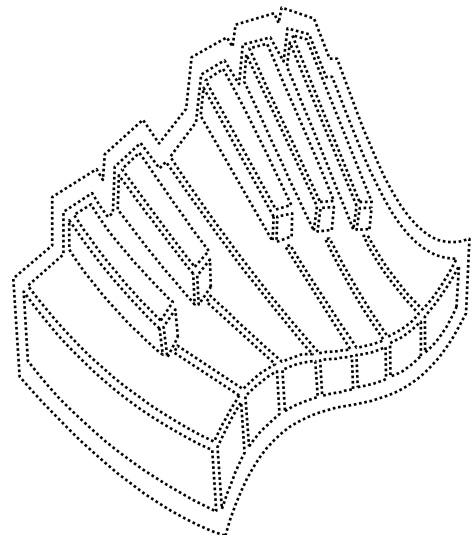
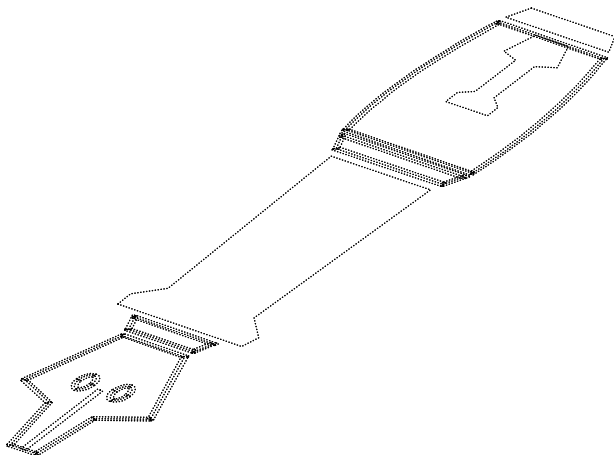



**2-Match the words with the pictures :**

1-pen

2-pencil

3-play

4-plane

5- piano

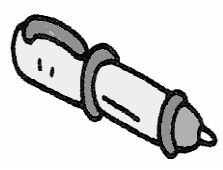
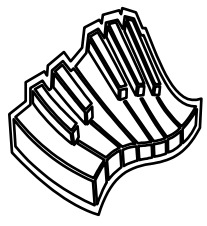

**3- LISTEN AND CIRCLE THE CORRECT PICTURE**

1.



2.

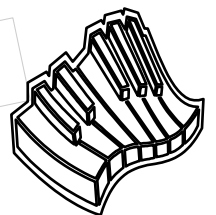
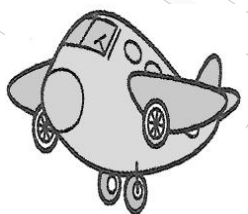

3.

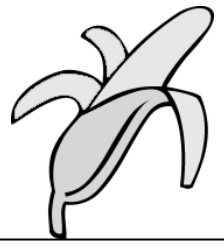
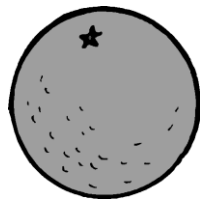
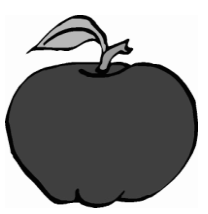

4.

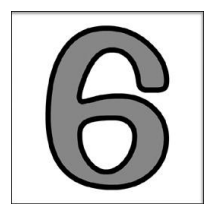
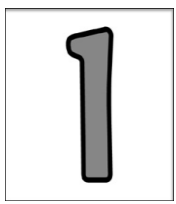

Qq



Qq

Q Q Q Q Q Q Q

q q q q q q q q q

Qq Qq Qq Qq Qq

Qq

quilt quilt quilt quilt

quilt

# Qq



## 17-Colour and say:

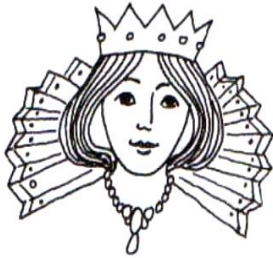

queen

# Qq

**1-Rearrange the following letters to make meaningful words:**

1- pne

2- pencli

3- plya

.....

.....

.....

5- piaon

7- kiet

6- cta

.....

.....

.....

**2-Match the words with the pictures :**

1-queen

2-kite

3- banana

4-book

5-bee

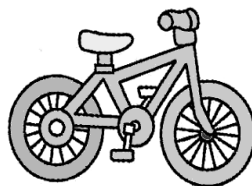
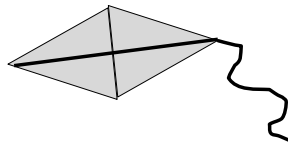



# Rr



## 18-Colour and say:

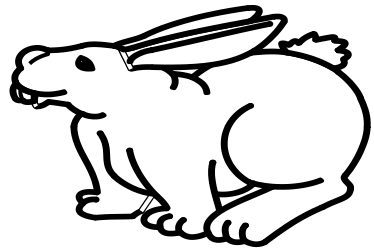

rabbit

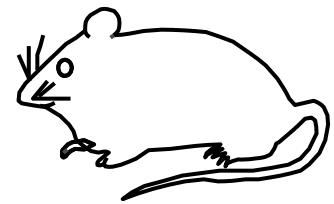

rat

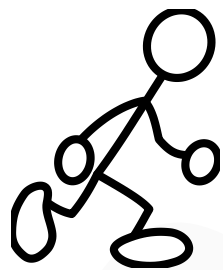

run

# Rr

1-Write the first letter:



2-Match the words with the pictures :

1-rabbit

2-rat

3-run



Ss



Ss

S S S S S S S S S

s s s s s s s s s s

Ss Ss Ss Ss Ss Ss

Ss

star star star star

star

# Ss



## 19-Colour and say:

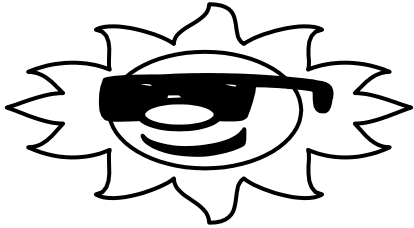

sun

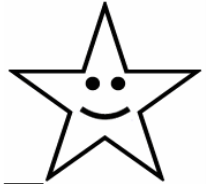

star

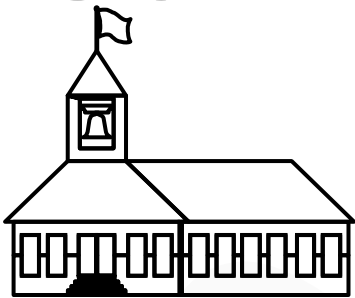
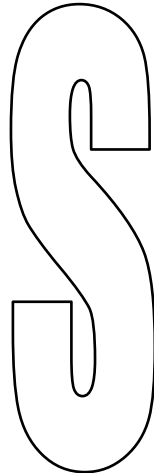

school



six



seven

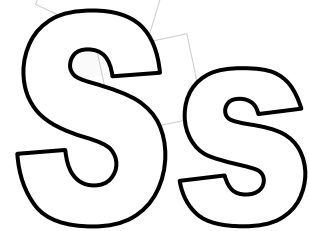

### Fun Zone

1-Match and colour:

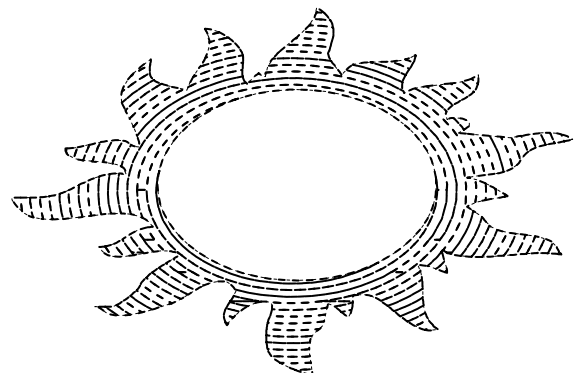
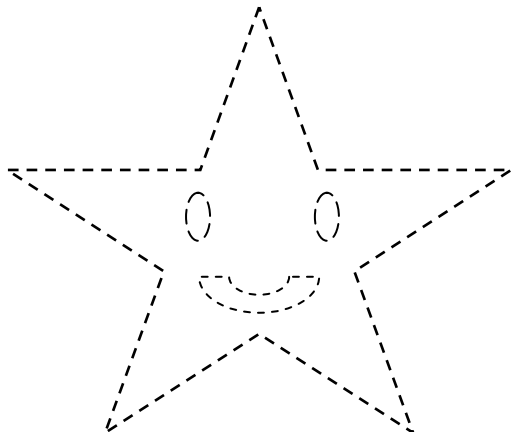

## 2-Listen and do :

- 1- Stand up.
- 2- Sit down.
- 3- Open your book.
- 4- Close your book.
- 5- Spell your name.

## 3-Draw , colour and say:

one apple	two apples	three apples
one book	two books	three books
one boy	two boys	three boys



Tt



Tt

Tt (with stroke order arrows and numbers 1 and 2)

Tt (with stroke order arrows and numbers 1 and 2)

Tt (with dotted tracing lines)

Tt (with solid lines)

tiger tiger tiger tiger

tiger

# Tt

## 20-Colour and say:



2  
two



tree

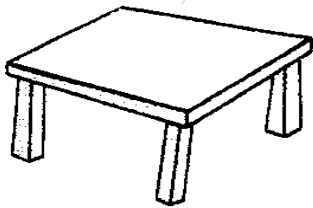

table

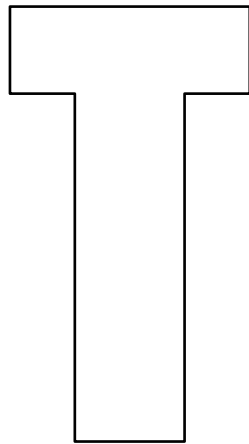

10  
ten

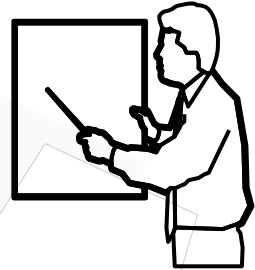

teacher



telephone

1-Match and say the numbers :

1- 4

2- 5

3- 6

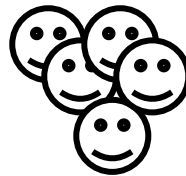
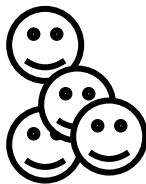

Uu



Uu

U U U U U U U U

u u u u u u u u

Uu Uu Uu Uu Uu

Uu

umbrella umbrella

umbrella

# Uu

## 21-Colour and say:

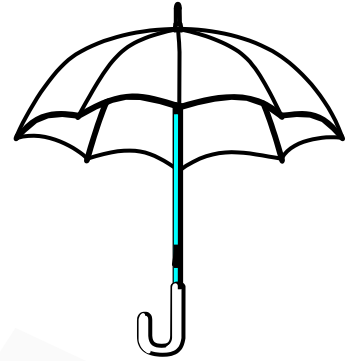
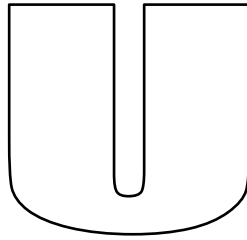

under

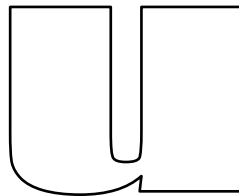

umbrella

### 1-Match the words with the pictures :

1- umbrella

2- book

3-tree

4-table

5-telephone

6-two

7-teacher

8-seven

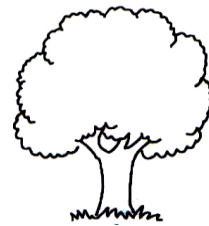
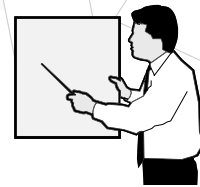

**2- Write the capital letters for the following small letters :**

a            b            c            d            e            f

.....

g            h            i            j            k            l

.....

m            n            o            p            q            r

.....

s            t            u

.....

**3- Look at the pictures. Read the words and circle (Yes) or (No):**

Yes	✓	No	X
-----	---	----	---

1- A tree.

Yes

No



2- A boy.

Yes

No



3- A book.

Yes

No

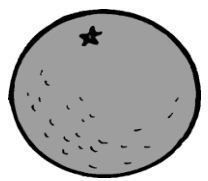

4- An egg .

Yes

No

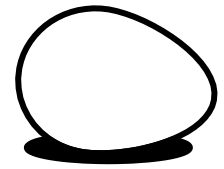

Vv

Vv



V V V V V V V V V V

v v v v v v v v v v

Vv Vv Vv Vv Vv Vv

Vv

vegetables vegetables

vegetables

Vv



# 22-Colour and say:

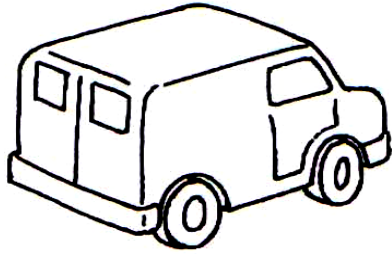

van

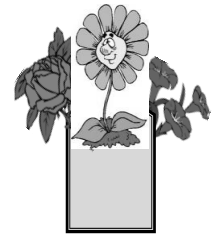
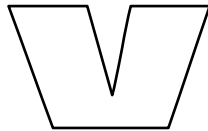
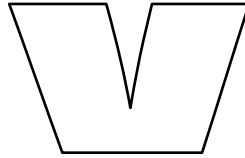

vase

## 1-Match the numbers :

- 1-one
- 2-two
- 3-three
- 4-five
- 5-four
- 6-six
- 7-seven

4

2

5

3

6

1

7

## 2- Look at the pictures and the letters , then write the words :

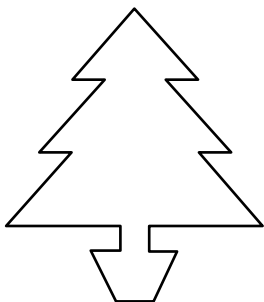

teer

.....

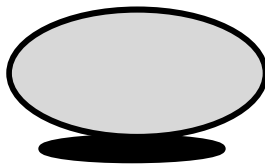

gge

.....



oby

.....

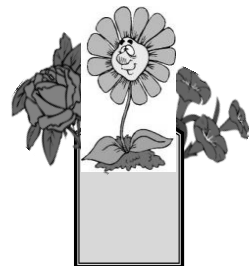

vaes

.....

Ww

Ww



Ww (with stroke order arrows 1-4)

w (with stroke order arrows 1-4)

Ww (dotted for tracing)

Ww

whale (dotted for tracing)

whale



# Ww



## 23-Colour and say:

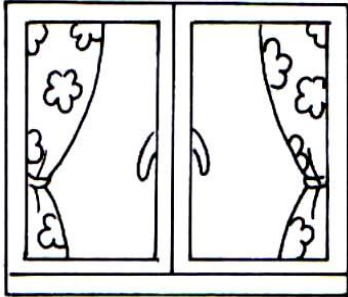

window

write

### Fun Zone

1-Match and colour:

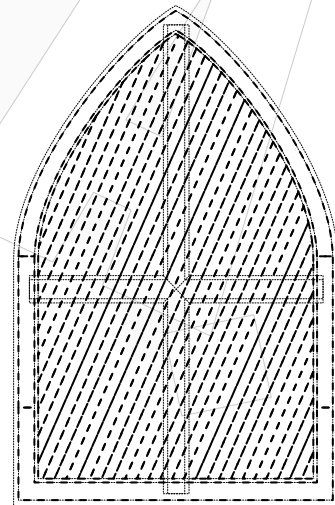

2-Match the words with the pictures :

1-window

2-write

3-van

4-vase

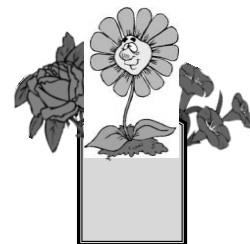
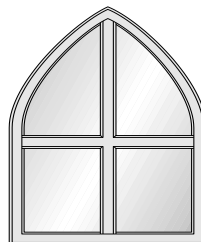

# Xx

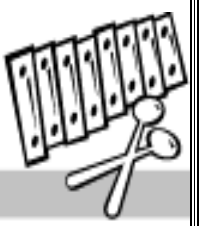

Xx

X X X X X X X X X X

x x x x x x x x x x

Xx Xx Xx Xx Xx Xx Xx Xx Xx

Xx

xylophone xylophone

xylophone

Xx



24-Colour and say:

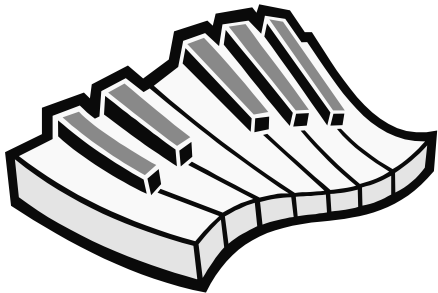

xylophone

Xx

### Fun Zone

1-Match and colour:

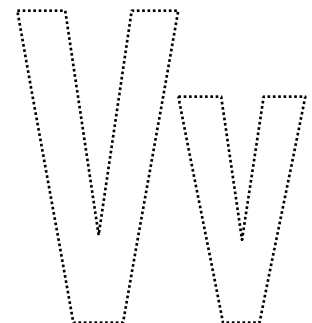
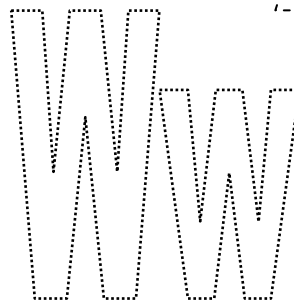
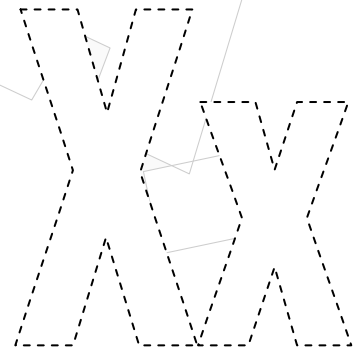
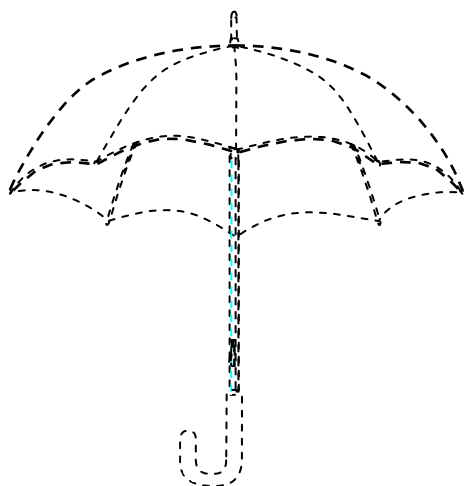
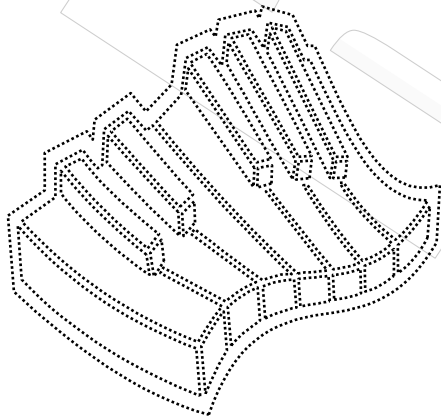

**2-Match the words with the pictures :**

1-six

2-ten

3-tree

4-xylophone

5-taxi

6-sun

7-star

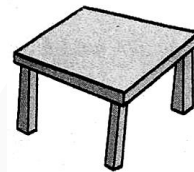
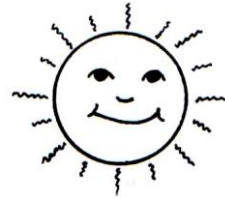
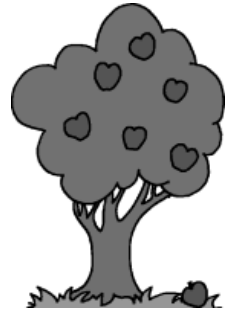
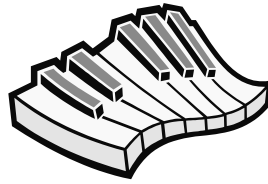

**3- Listen to the words and circle the right picture :**

1-

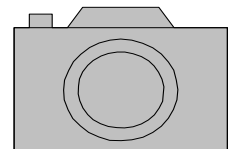
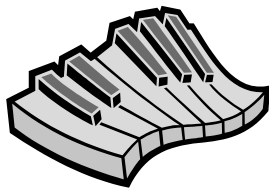

2-

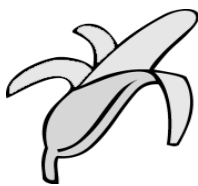

3-

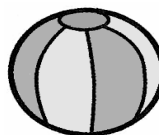

Yy

Yy



Yy Yy Yy Yy Yy Yy Yy Yy

Yy Yy Yy Yy Yy Yy Yy Yy

Yy Yy Yy Yy Yy Yy Yy Yy

Yy Yy

yarn yarn yarn yarn

yarn

Yy



# 25-Colour and say:



yoyo

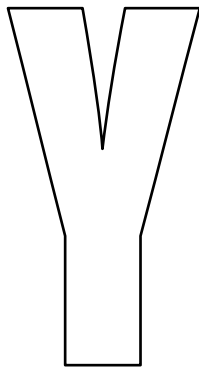

yellow



Yes



you

## 1-Match the words with the pictures :

1-yoyo

2-yes

3-boy

4-fish

5-you

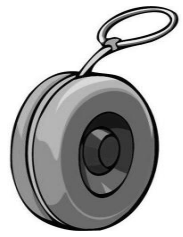
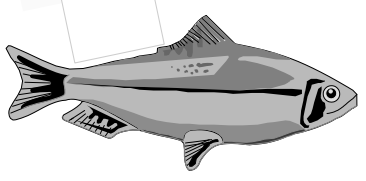

**YOU!**

Zz

Zz



Z Z Z Z Z Z Z Z Z Z Z Z Z Z Z Z

z z z z z z z z z z z z z z z z

Zz Zz Zz Zz Zz Zz Zz Zz Zz Zz

Zz Zz Zz Zz Zz Zz Zz Zz Zz Zz

zebra zebra zebra zebra zebra zebra zebra zebra zebra zebra

zebra zebra zebra zebra zebra zebra zebra zebra zebra zebra

# Zz

## 26-Colour and say:



zoo



zebra

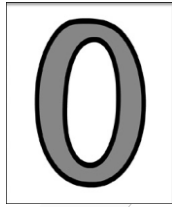

zero



1-Match the words with the pictures :

1-zoo

2-zero

3-zebra

4-rat

5-queen

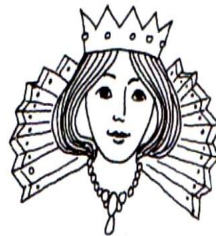
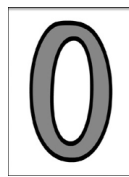



**2-Write the number under each box:**

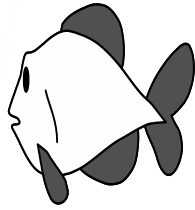



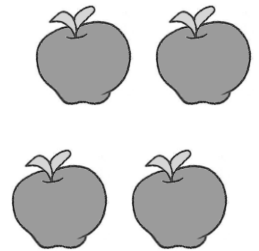

**3- Look at the pictures. Read the words and circle (Yes) or (No):**

Yes



No

X

1- A zoo.

Yes

No



2- A zebra.

Yes

No

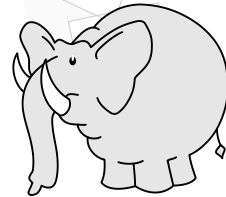

3- A hen.

Yes

No



4- A pen.

Yes

No

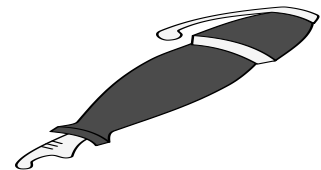

5- An arm .

Yes

No



# Mr Ragab's Mini-dictionary

**apple**

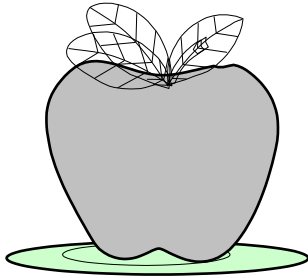

**Aa**

**book**

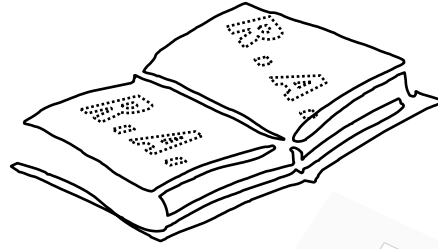

**Bb**

**car**



**Cc**

**dog**



**Dd**

**egg**

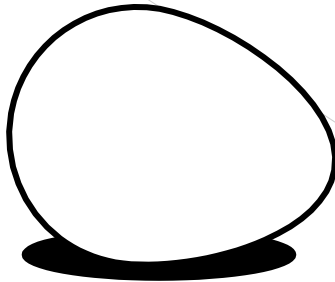

**Ee**

**fish**

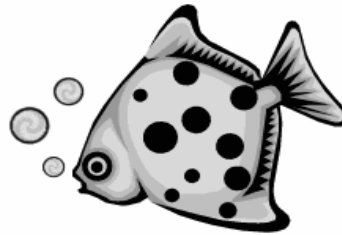

**Ff**

**girl**



**Gg**

**hat**

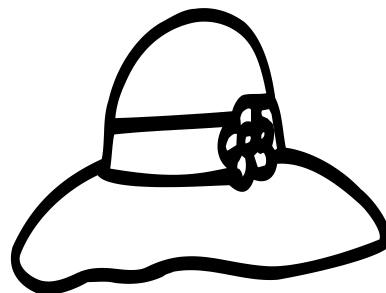

**Hh**

**ice cream**



Ii

**jacket**



Jj

**kite**

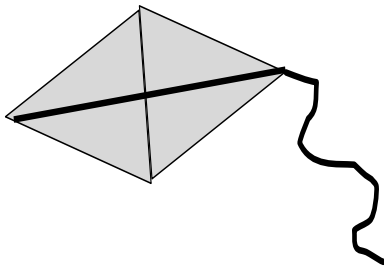

Kk

**lion**

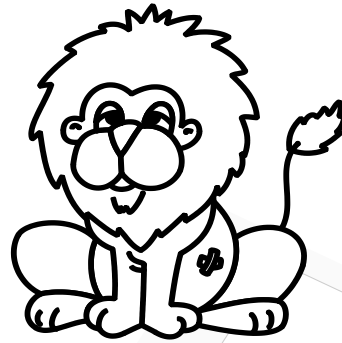

Ll

**mouse**



Mm

**nose**

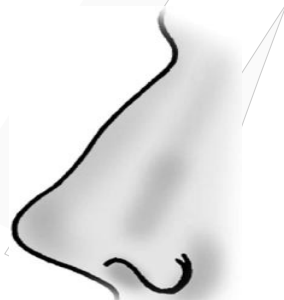

Nn

**orange**

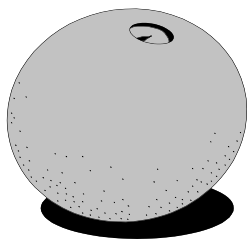

Oo

**pencil**

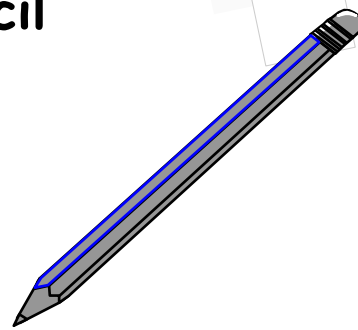

Pp

**queen**



Qq

**rabbit**

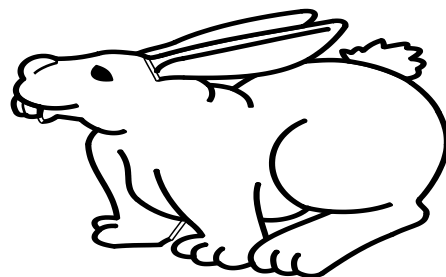

Rr

**sun**

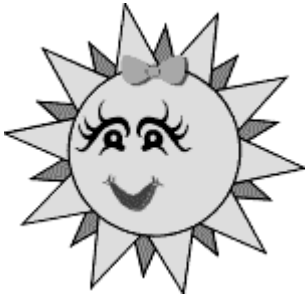

**Ss**

**tree**



**Tt**

**umbrella**



**Uu**

**vase**



**Vv**

**window**

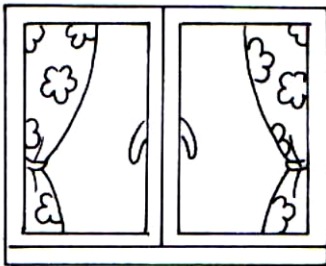

**Ww**

**x**

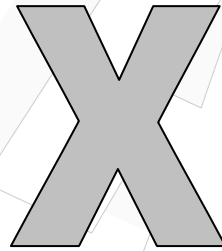

**Xx**

**yoyo**

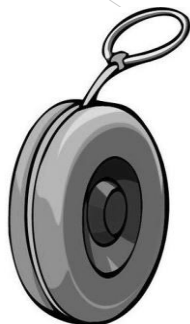

**Yy**

**zoo**



**Zz**

**By:**

**Mr Ragab Ahmed**

*Compiled by: Mr Ragab Ahmed*

Aa

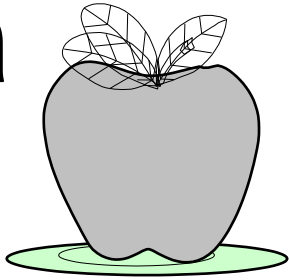

apple تفاحة



ant نملة

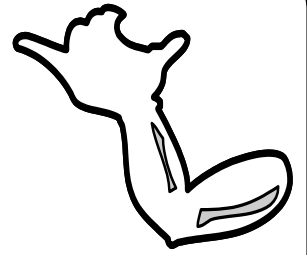

arm ذراع

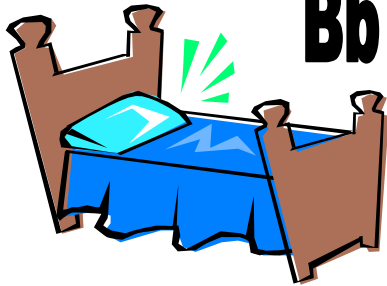

bed سرير



bag شنطة



bedroom حجرة النوم

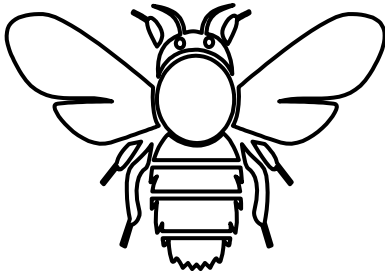

bee نحلة

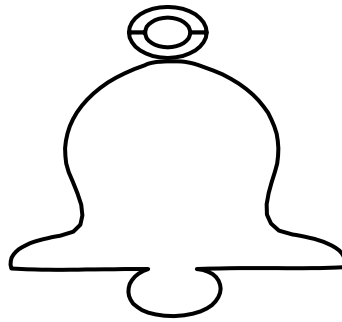

bell جرس



black اللون الأسود



blue اللون الأزرق

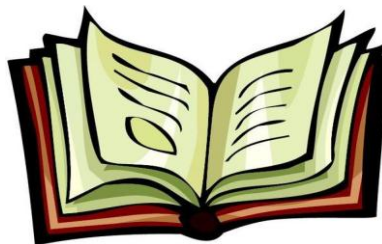

book كتاب



boy ولد

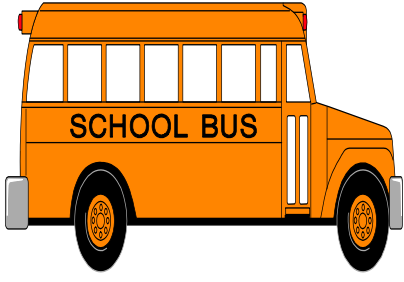

bus أتوبيس



ball كرة

Cc

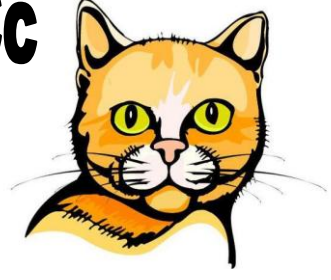

cat قطة



car سيارة

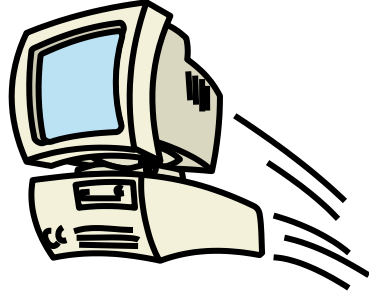

computer حاسب آلي

Dd

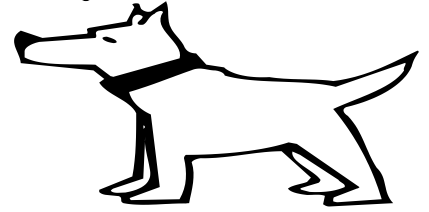

dog كلب



donkey حمار

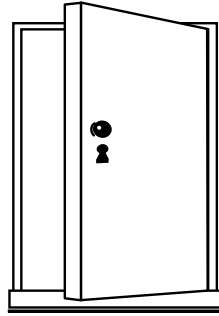

door باب

Ee

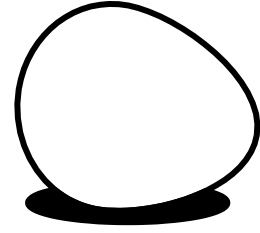

egg بيضة

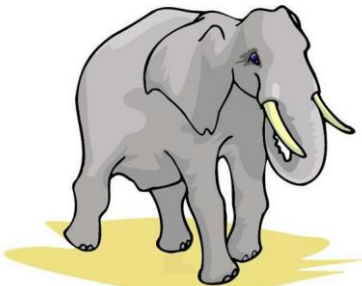

elephant فيل

Ff



father بابا



family عائلة ، أسرة



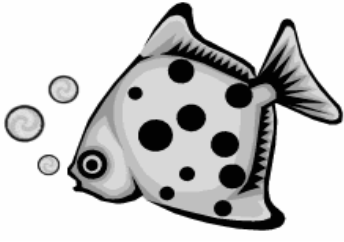

fish سمكة



finger إصبع اليد



flag علم

**Gg**



girl بنت



goat معزة



اللون الأخضر green

**Hh**



hat برنيطة



house منزل



ice cream آيس كريم

**Ii**

**Jj**



jacket جاكيت



jump يقفز

**Kk**

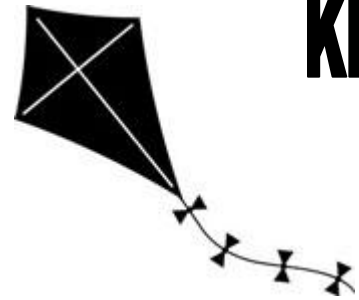

kite طائرة ورق

**Ll**

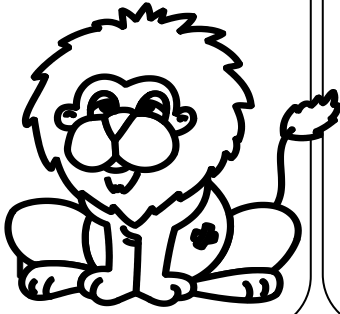

مصاصة  
lollipop

**Mm**



فأر صغير  
mouse



أم  
mother



سجادة  
mat

**Nn**

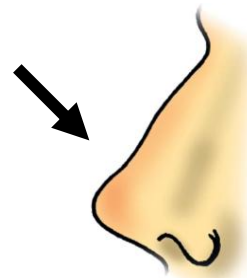

أنف  
nose

**9**

تسعة  
nine

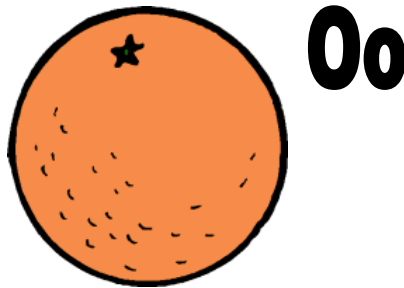

برتقالة  
orange

**Oo**

**1**

واحد  
one

**Pp**

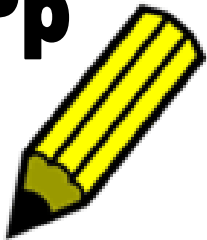

قلم رصاص  
pencil

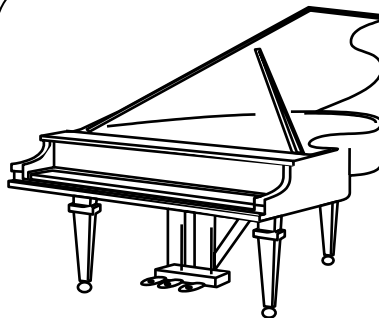

بيانو  
piano

**Qq**



ملكة  
queen



**Rr**

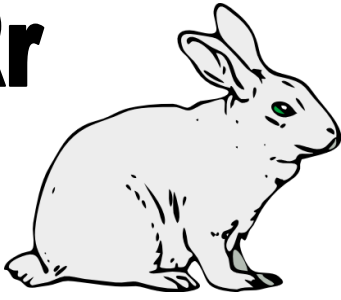

rabbit أرنب



run يجرى

**Ss**

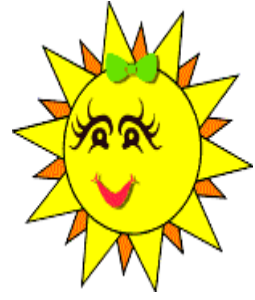

sun شمس

**6**

six ستة

**7**

seven سبعة

**Tt**

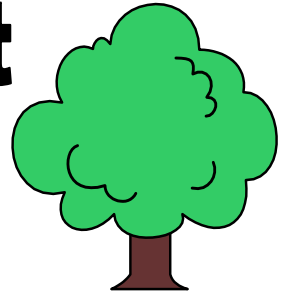

tree شجرة

**Mr Ragab**

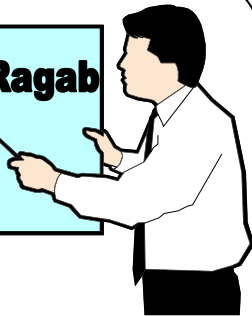

teacher مدرس

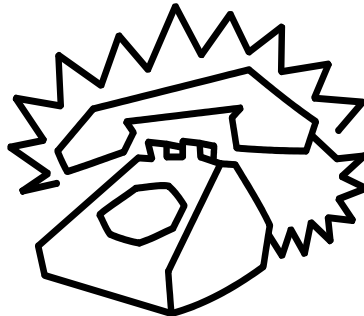

telephone تليفون

**Uu**



umbrella شمسية

**Vv**



vase زهرية

**Ww**



window شباك

**Xx**

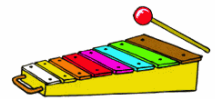

xylophone

xylophone آلة موسيقية

**Yy**



yoyo يويو

**Zz**



zoo حديقة حيوان



zebra حمار وحشي مخطط

## Songs أغاني

✂ Leila has a little cat, a little cat, a little cat.

✂ Leila has a little cat.

✂ Its name is Mr Cat.



**Children:** Hello, teacher. Hello, teacher.

How are you? How are you?

**Miss Mona:** I'm fine, thank you.

I'm fine, thank you.

How are you? How are you?



Hi, rabbit! , Hi, rabbit!

Run! Run! Run!

Hi, rabbit! Hi, rabbit!

Run! Run! Run!

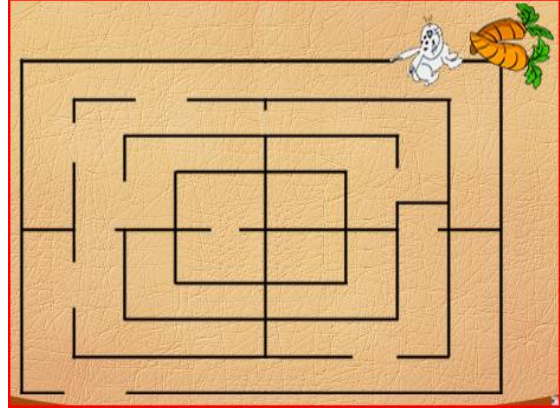

### المفرد والجمع Singular & plural

المفرد Singular

الجمع Plural

سيارة (واحدة) car



سيارات cars



قطعة (واحدة) cat



قطط cats

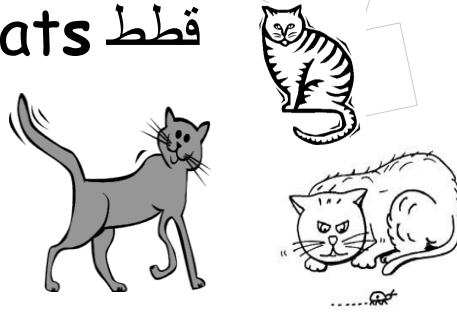

ولد (واحد) boy



أولاد boys

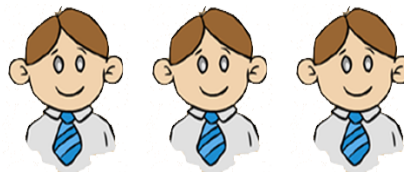

# The Alphabet



Aa Bb Cc Dd Ee

Ff Gg Hh Ii Jj Kk

Ll Mm Nn Oo Pp

Qq Rr Ss Tt Uu Vv

Ww Xx Yy Zz

# Numbers

zero <b>0</b>	one <b>1</b>	two <b>2</b>	three <b>3</b>	four <b>4</b>
five <b>5</b>	six <b>6</b>	seven <b>7</b>	eight <b>8</b>	nine <b>9</b>
ten <b>10</b>	eleven <b>11</b>	twelve <b>12</b>	thirteen <b>13</b>	fourteen <b>14</b>
fifteen <b>15</b>	sixteen <b>16</b>	seventeen <b>17</b>	eighteen <b>18</b>	nineteen <b>19</b>
twenty <b>20</b>	twenty-one <b>21</b>	twenty-two <b>22</b>	twenty-three <b>23</b>	twenty-four <b>24</b>
twenty-five <b>25</b>	twenty-six <b>26</b>	twenty-seven <b>27</b>	twenty-eight <b>28</b>	twenty-nine <b>29</b>
thirty <b>30</b>	forty <b>40</b>	fifty <b>50</b>	sixty <b>60</b>	seventy <b>70</b>
eighty <b>80</b>	ninety <b>90</b>	a hundred <b>100</b>	two hundred <b>200</b>	three hundred <b>300</b>
four hundred <b>400</b>	five hundred <b>500</b>	six hundred <b>600</b>	seven hundred <b>700</b>	eight hundred <b>800</b>
nine hundred <b>900</b>	a thousand <b>1000</b>			

والسلام عليكم ورحمة الله وبركاته  
أخوكم / مستر رجب

Compiled by: Mr Ragab Ahmed