



دفتر التمارين

# حروف في

اسم الطفل : .....

## بسم الله الرحمن الرحيم

الحمد لله رب العالمين و الصلاة و السلام  
على خير المرسلين ، نبينا محمد و على اله  
و صحبه أجمعين .

أما بعد : فإننا نضع بين يديكم دفتر التمارين  
التابع لفصل التميز ، فنسأل الله أن يبارك في الجهود و ينفع بها .

هالة مستور الحارثي

أ	ب	ت	ث	ج
ح	خ	د	ذ	ر
ز	س	ش	ط	ظ
ط	ظ	ع	ف	ق
ق	ك	ل	م	ن
ن	هـ	و	ي	

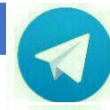

استخدم الصلصال في رسم الحرف :

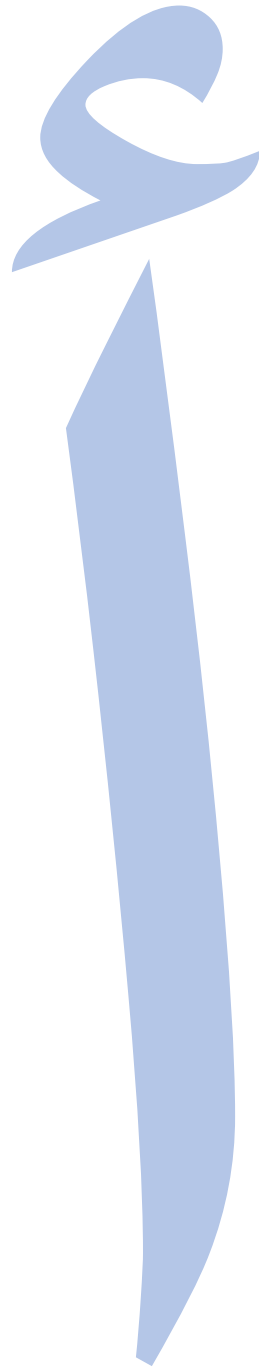

أ



أرنب

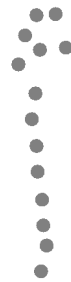
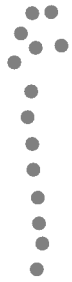



ا



ا



ا

قم بتلوين الرسمة التالية :

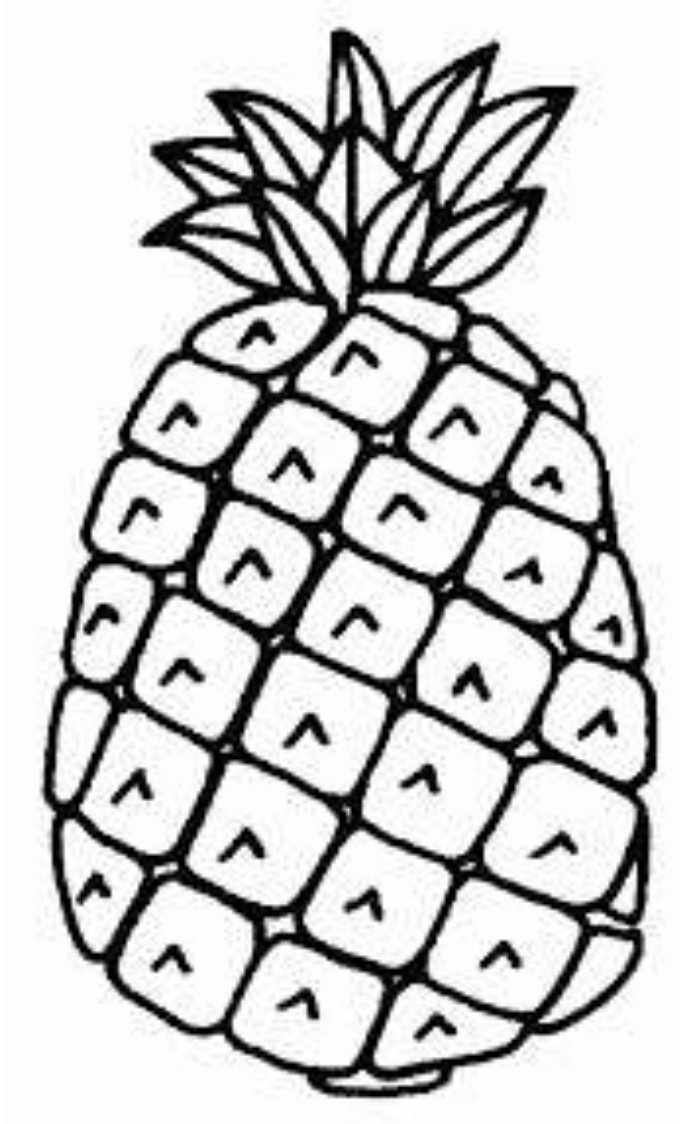

أناناس



استخدم الصلصال في رسم الحرف :





ب



بطة





ب



ب



ب

قم بتلوين الرسمة التالية :

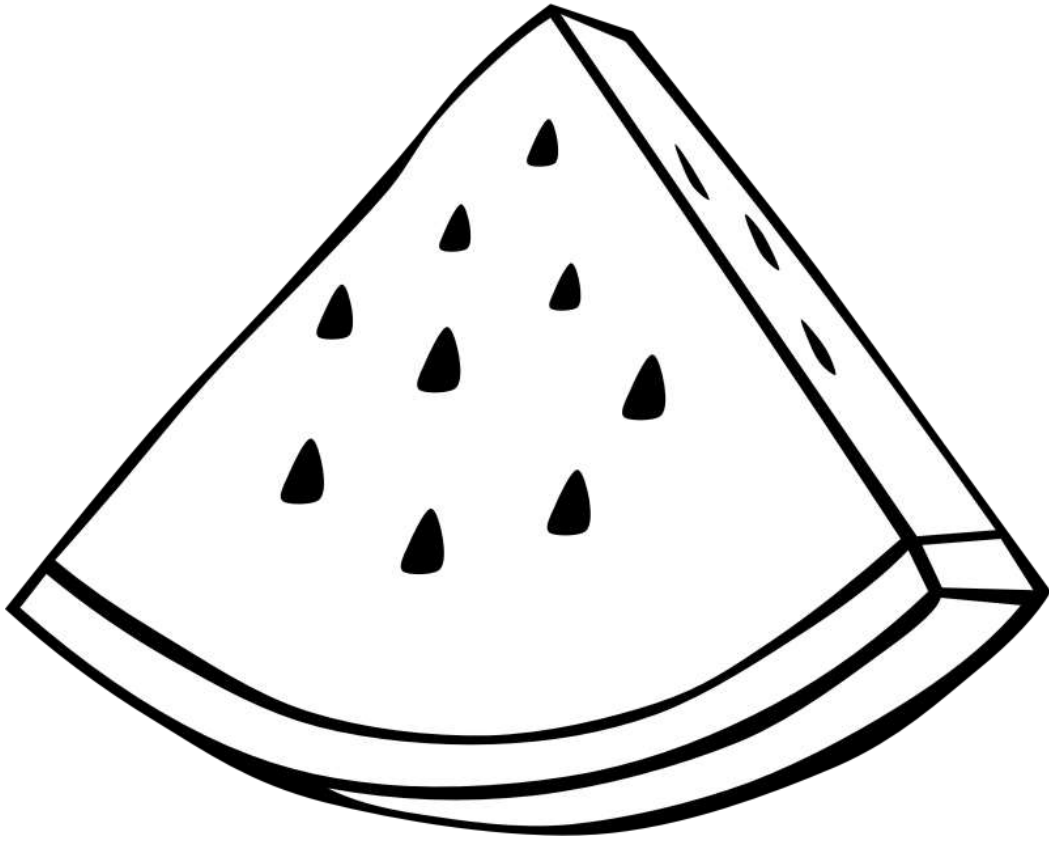

بطيخ



استخدم الصلصال في رسم الحرف :

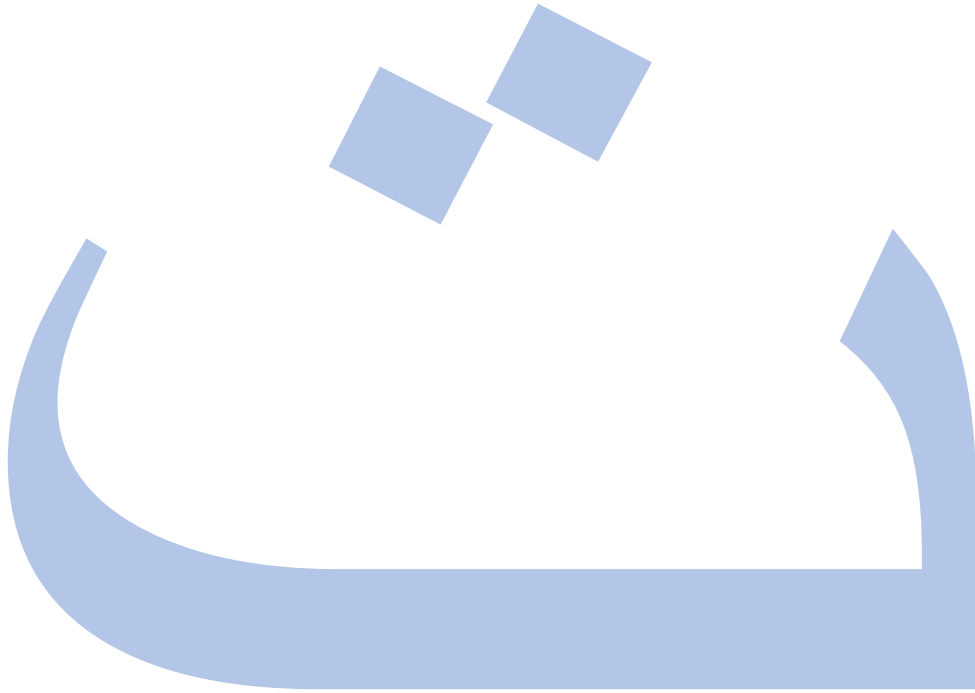

ث



تفاحة





ت



ث



د

قم بتلوين الرسمة التالية :

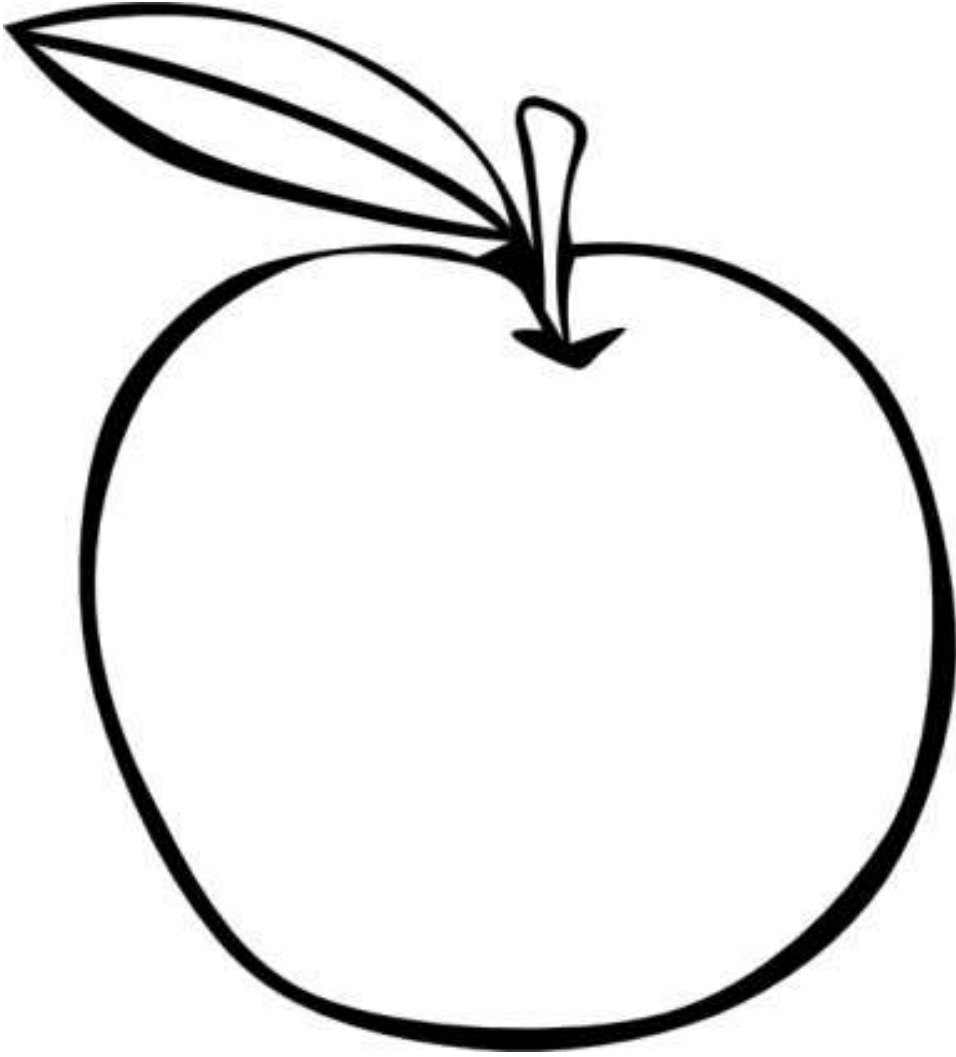

تفاح



استخدم الصلصال في رسم الحرف :

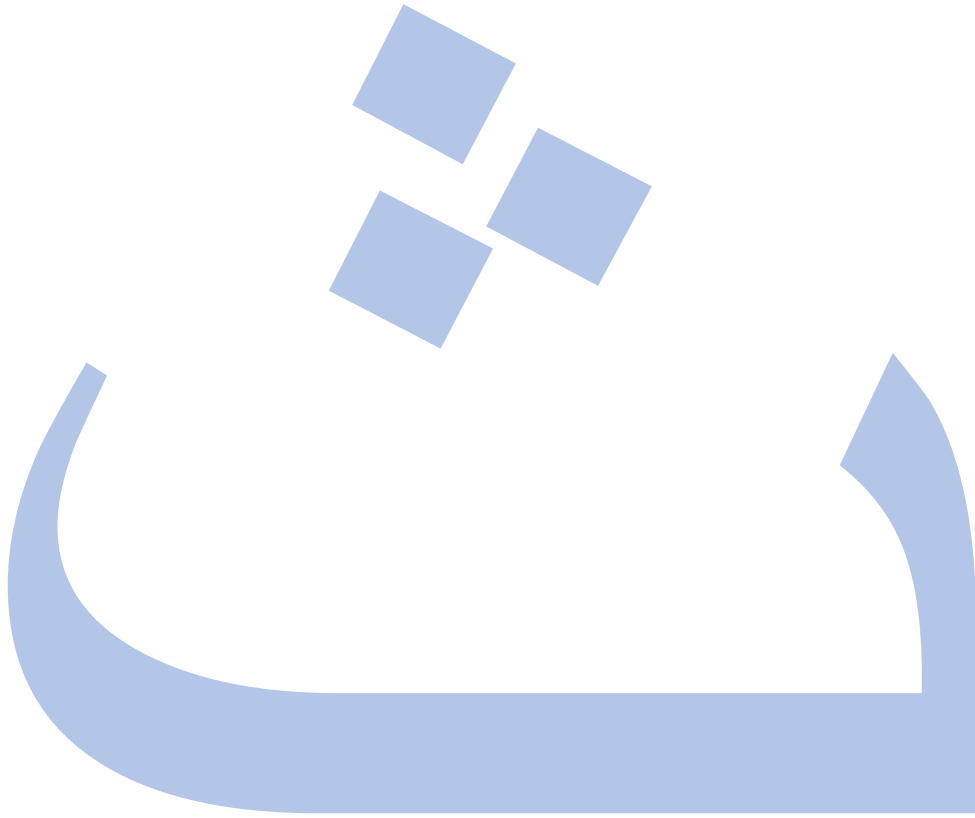



ث



ثعبان

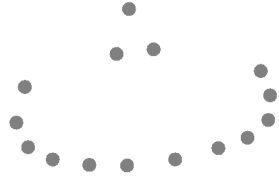
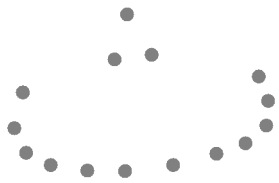



ت



ت



ت

قم بتلوين الرسمة التالية :

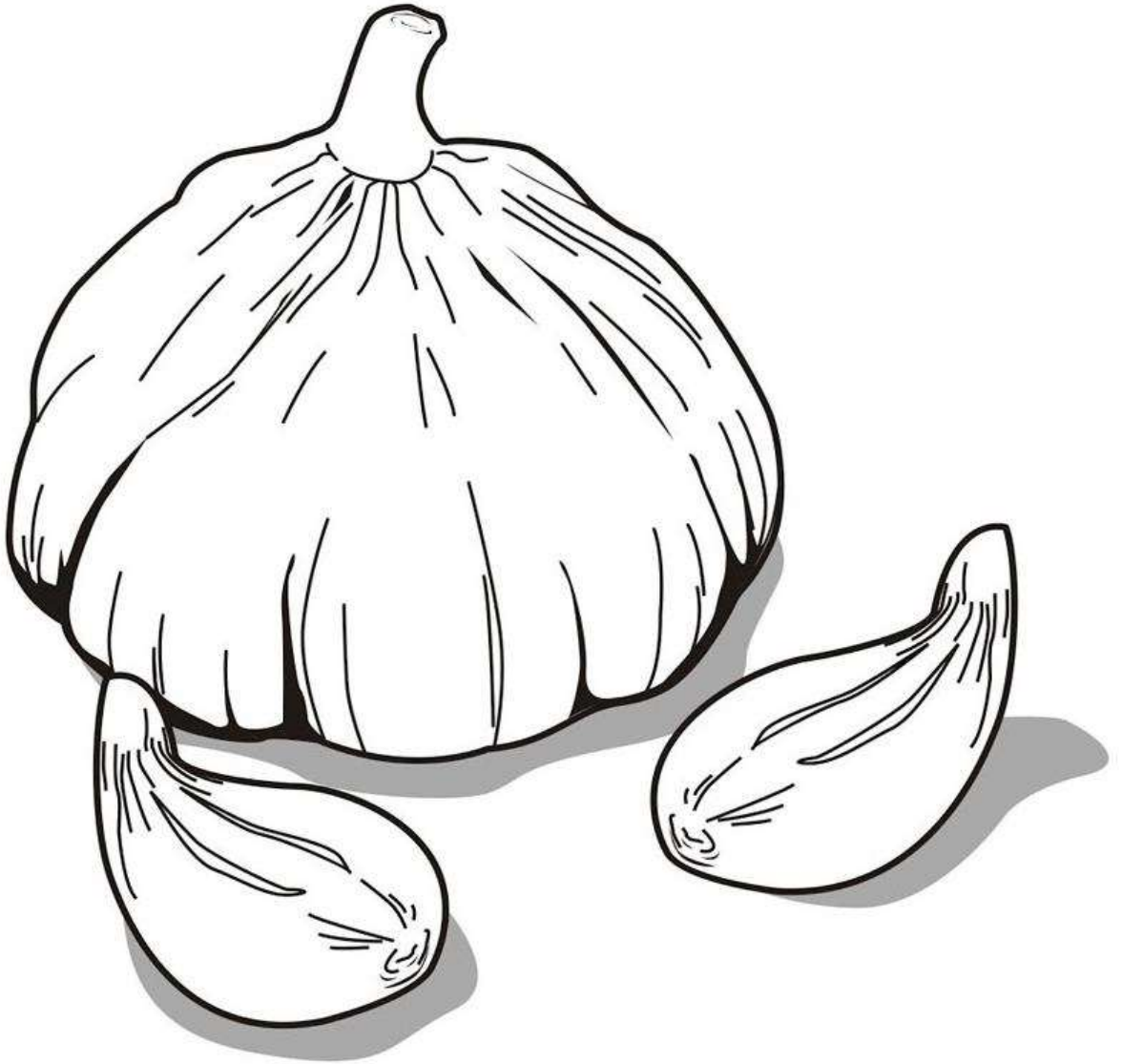

توم

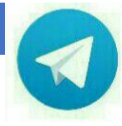

استخدم الصلصال في رسم الحرف :



ج



جزر

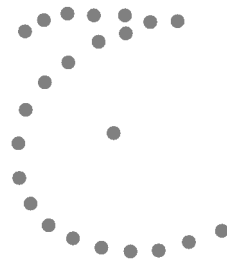
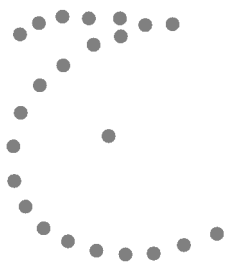
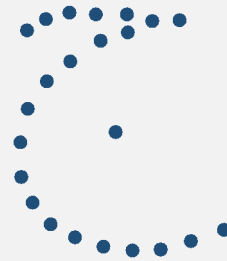
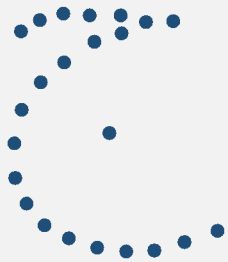



ج



ح



خ

قم بتلوين الرسمة التالية :



جزر

استخدم الصلصال في رسم الحرف :





ح



حليب

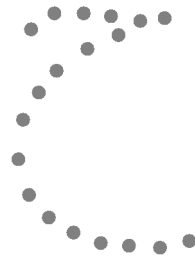
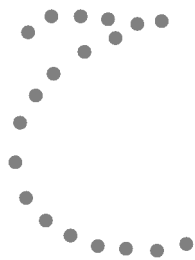



ع



ح



ه

قم بتلوين الرسمة التالية :



حقيقية



استخدم الصلصال في رسم الحرف :



خ



خبز

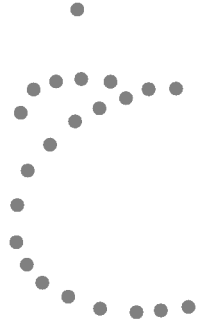
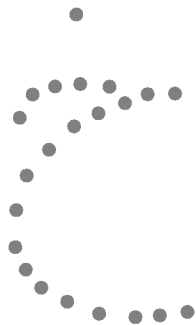



ح



خ



هـ

قم بتلوين الرسمة التالية :



خس



استخدم الصلصال في رسم الحرف :





ح



ب





ا



ا



ا

قم بتلوين الرسمة التالية :

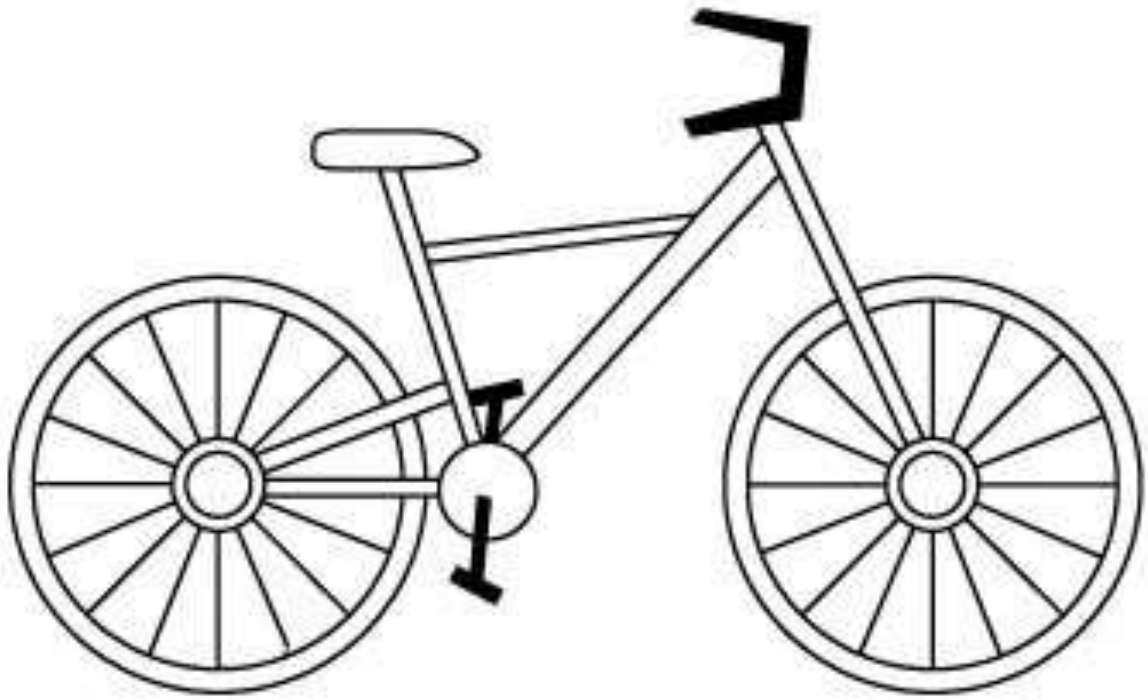

دراجة

استخدم الصلصال في رسم الحرف :



ذ



ذئب





ا



ب



ت

قم بتلوين الرسمة التالية :

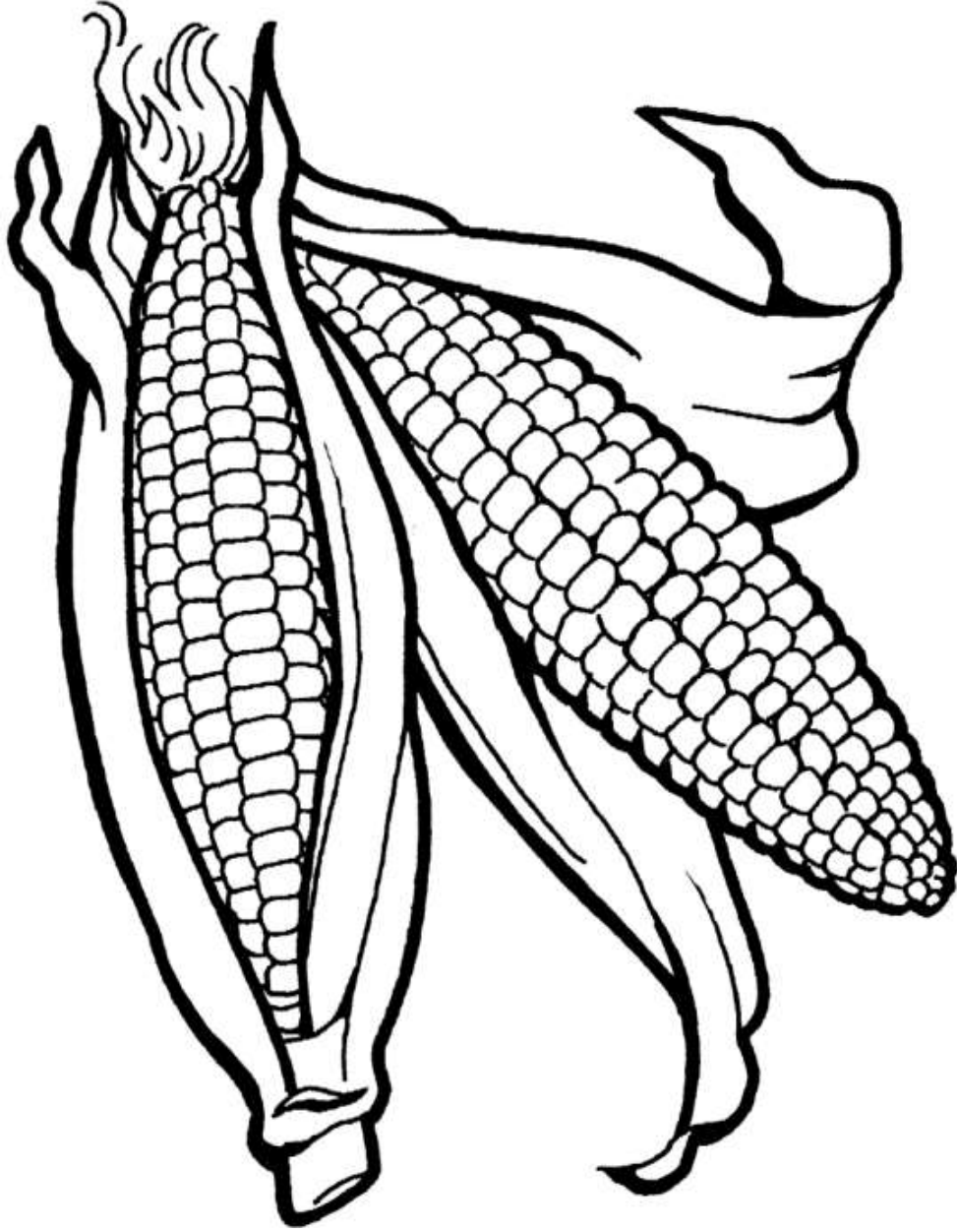

ذو

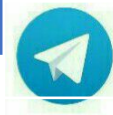

استخدم الصلصال في رسم الحرف :







رمان



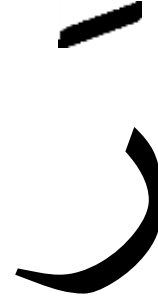

قم بتلوين الرسمة التالية :

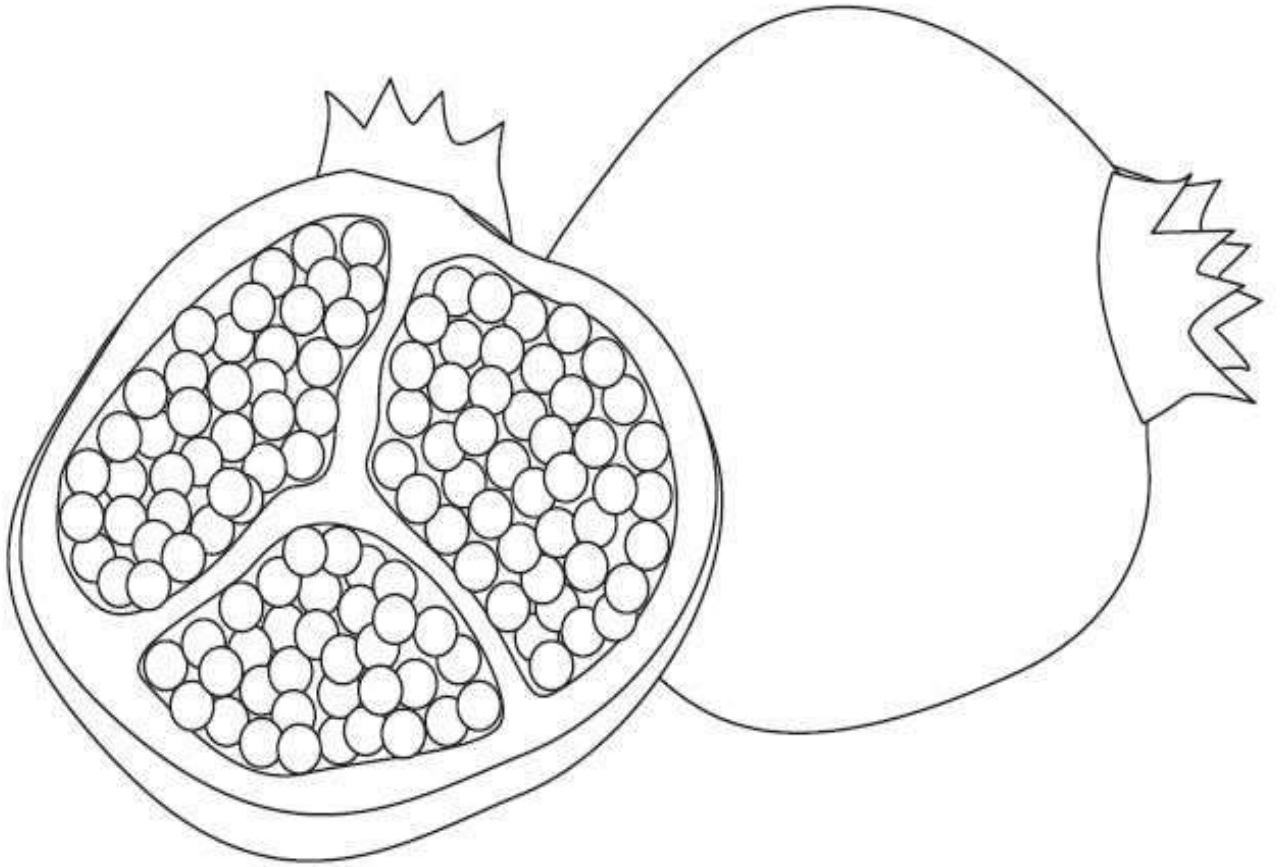

رمان

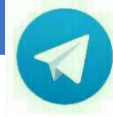

استخدم الصلصال في رسم الحرف :



ز



زهرة





ا



ب



م

قم بتلوين الرسمة التالية :

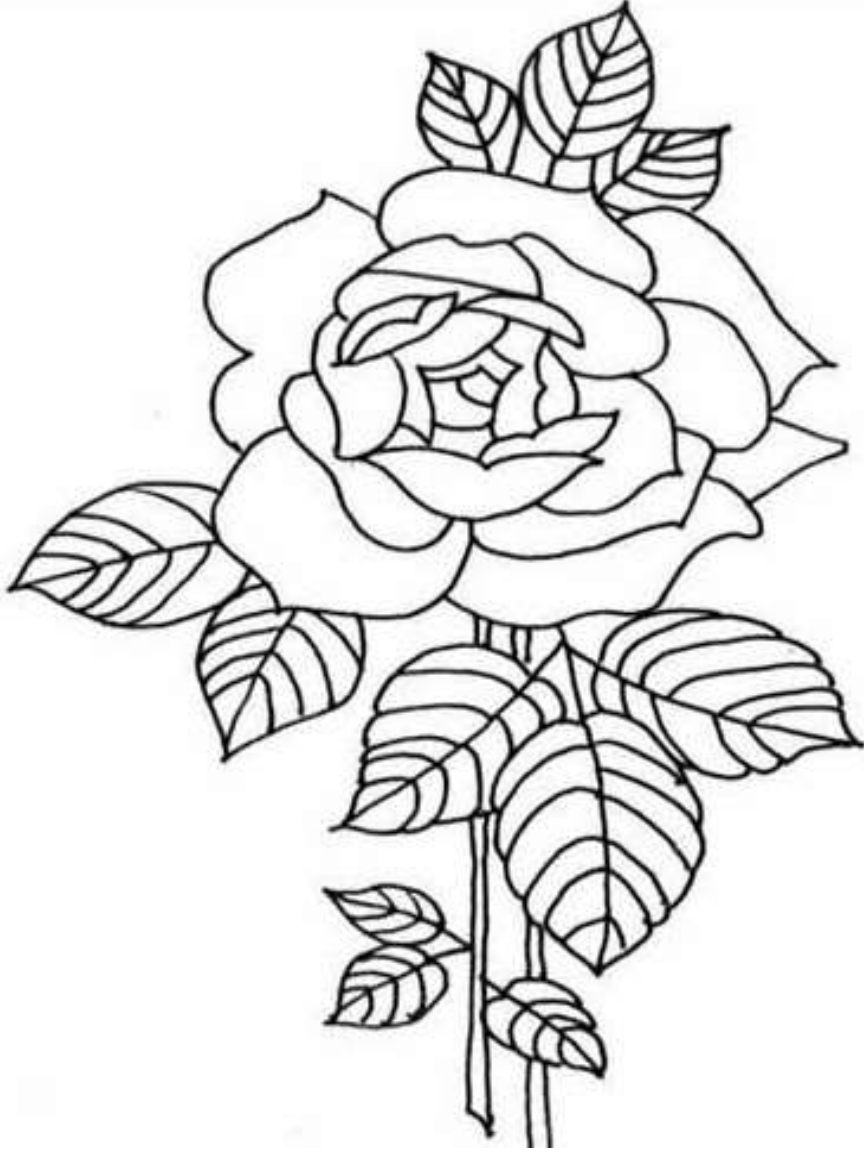

زفورة



استخدم الصلصال في رسم الحرف :





س



سمكة

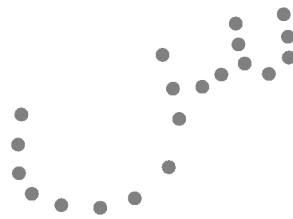
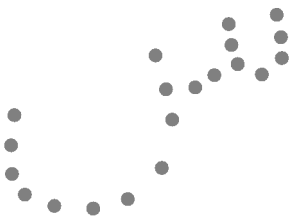



ا  
س



س  
ا



و  
س

قم بتلوين الرسمة التالية :

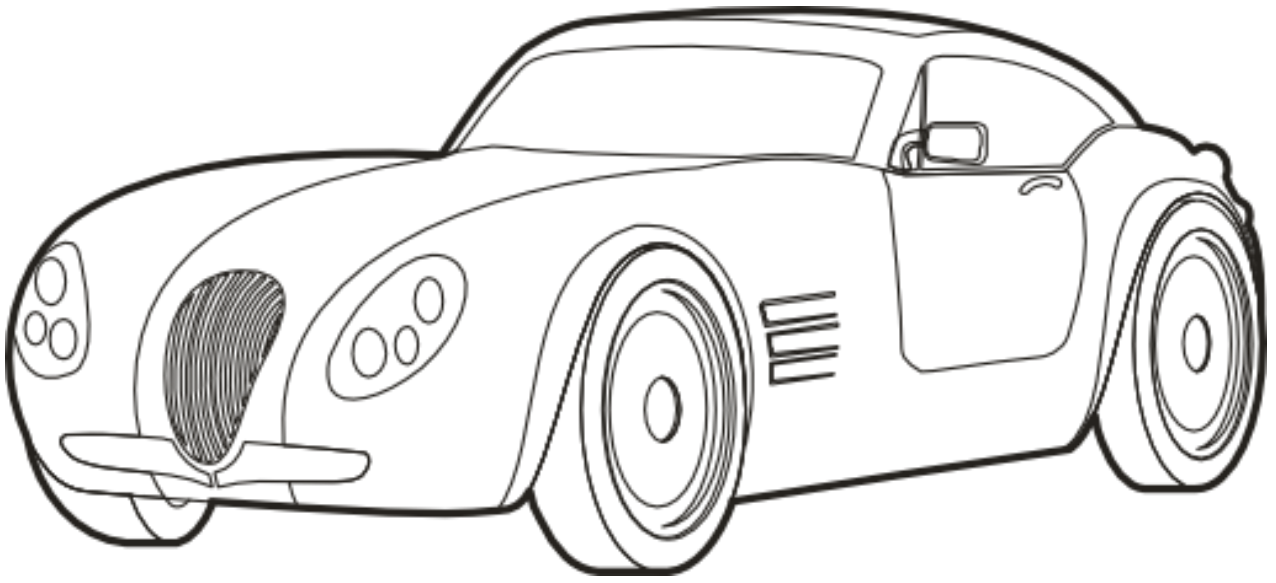

سيارة

استخدم الصلصال في رسم الحرف :



ش



شمس

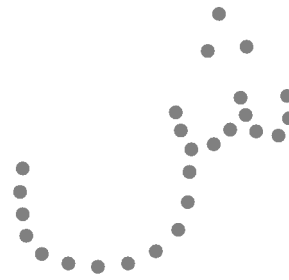
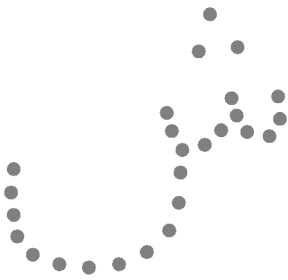



ا



آ



أ

قم بتلوين الرسمة التالية :

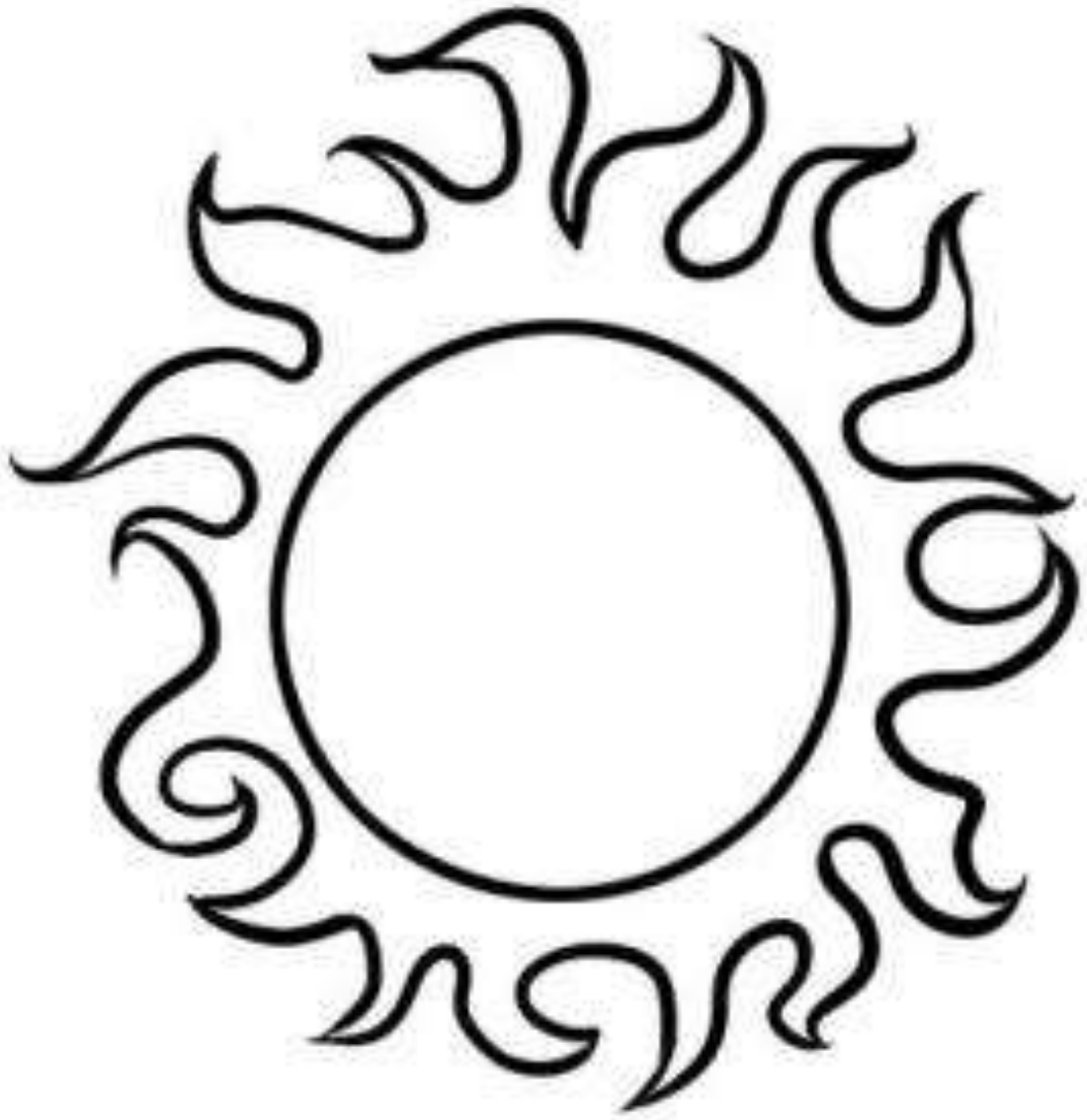

شمس

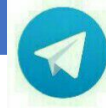

استخدم الصلصال في رسم الحرف :





ص



صحن

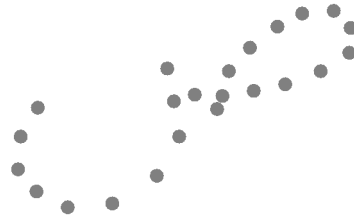
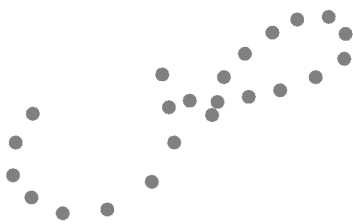
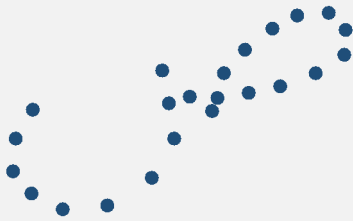



ط



ظ



ظ

قم بتلوين الرسمة التالية :

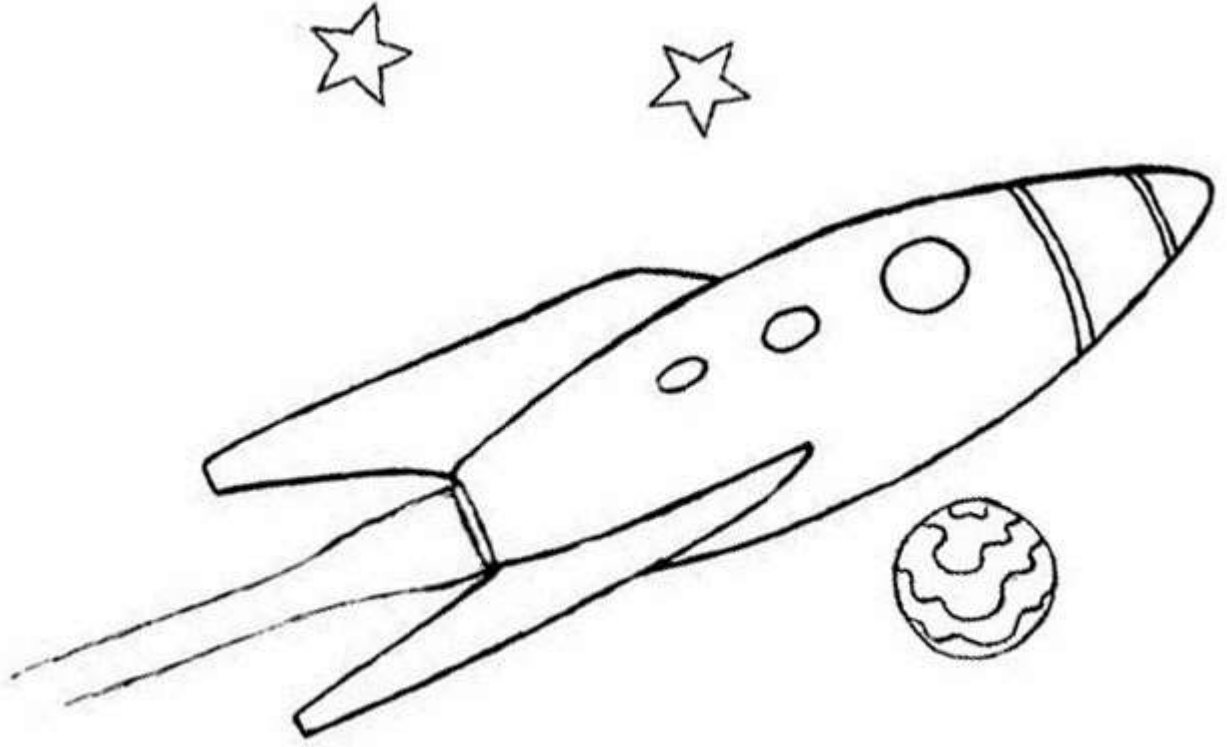

صاروخ

استخدم الصلصال في رسم الحرف :



ض



ضفادع

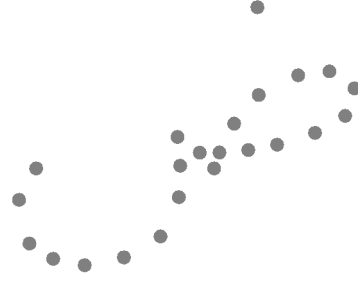
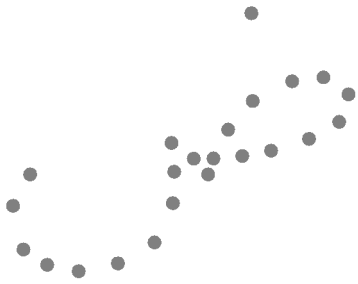
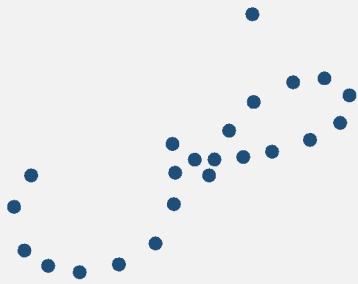



ظ



ظ



ظ

قم بتلوين الرسمة التالية :

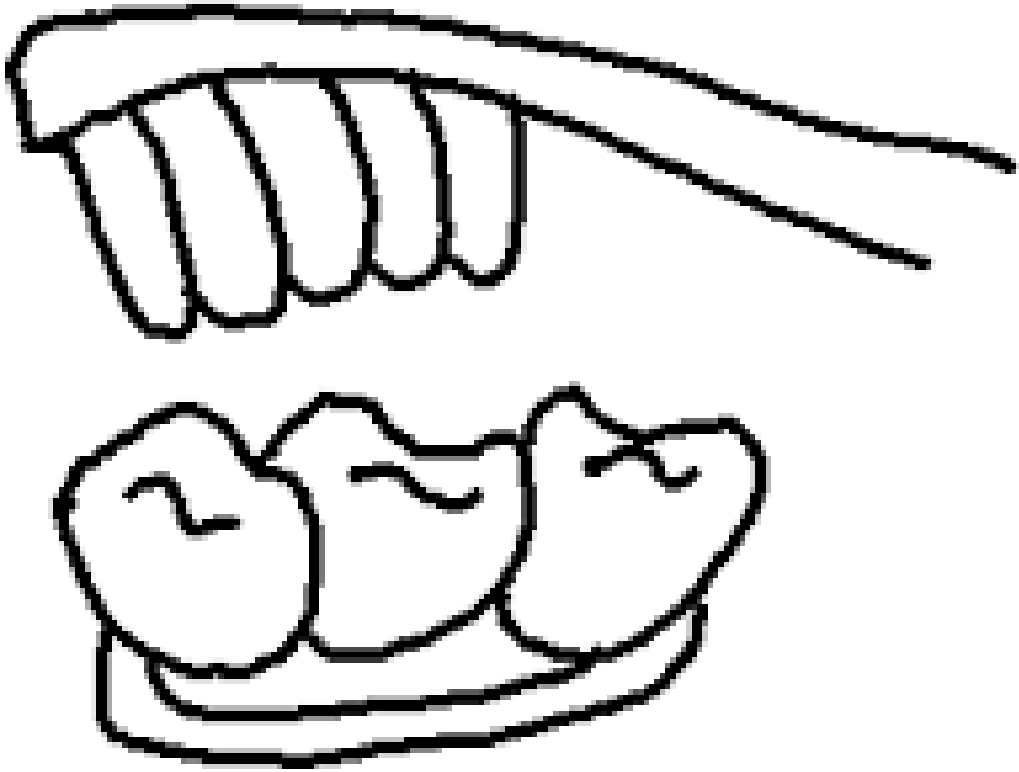

ضرس



استخدم الصلصال في رسم الحرف :

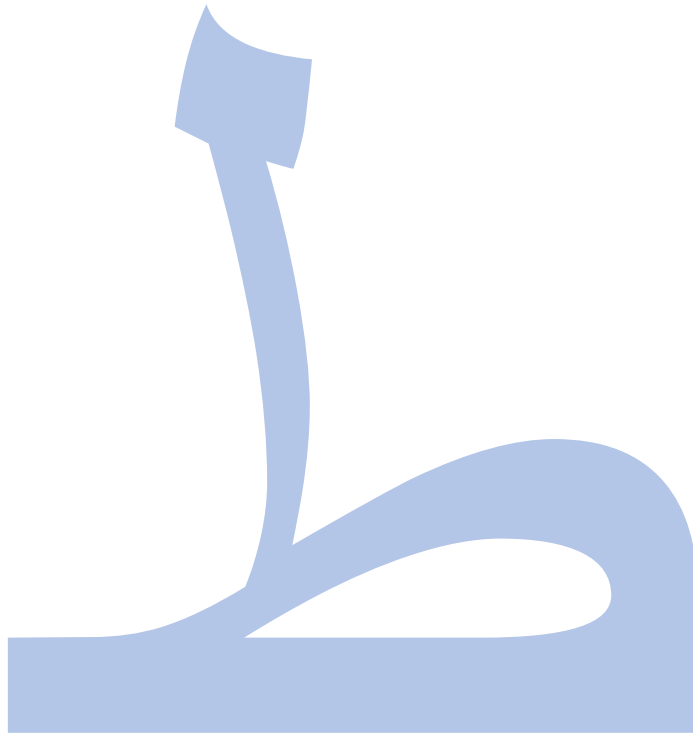





طائرة

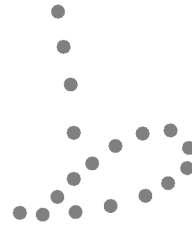
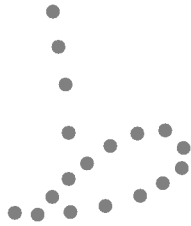



ط



ظ



ظ

قم بتلوين الرسمة التالية :

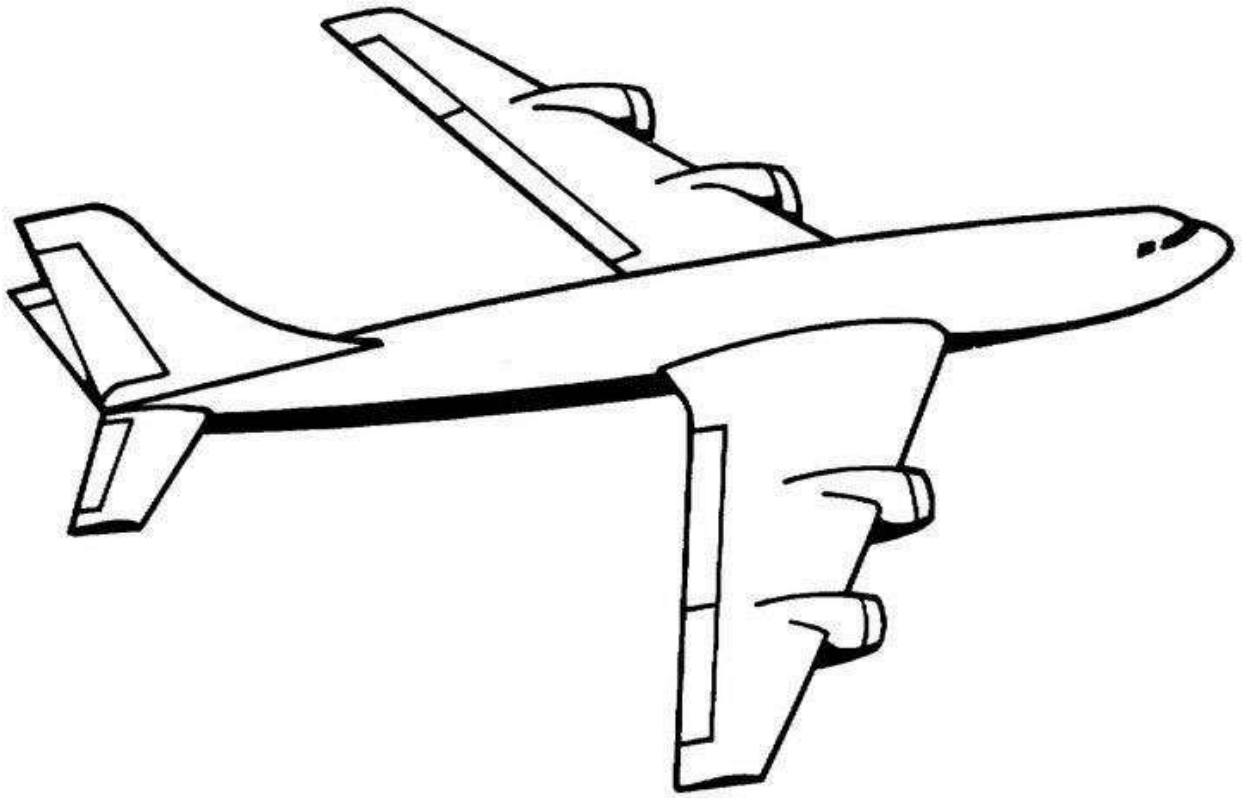

طائرة

استخدم الصلصال في رسم الحرف :



ظ



ظرف

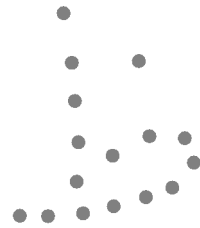
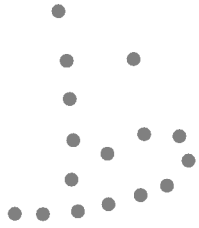



ظ



ظ



ظ

قم بتلوين الرسمة التالية :

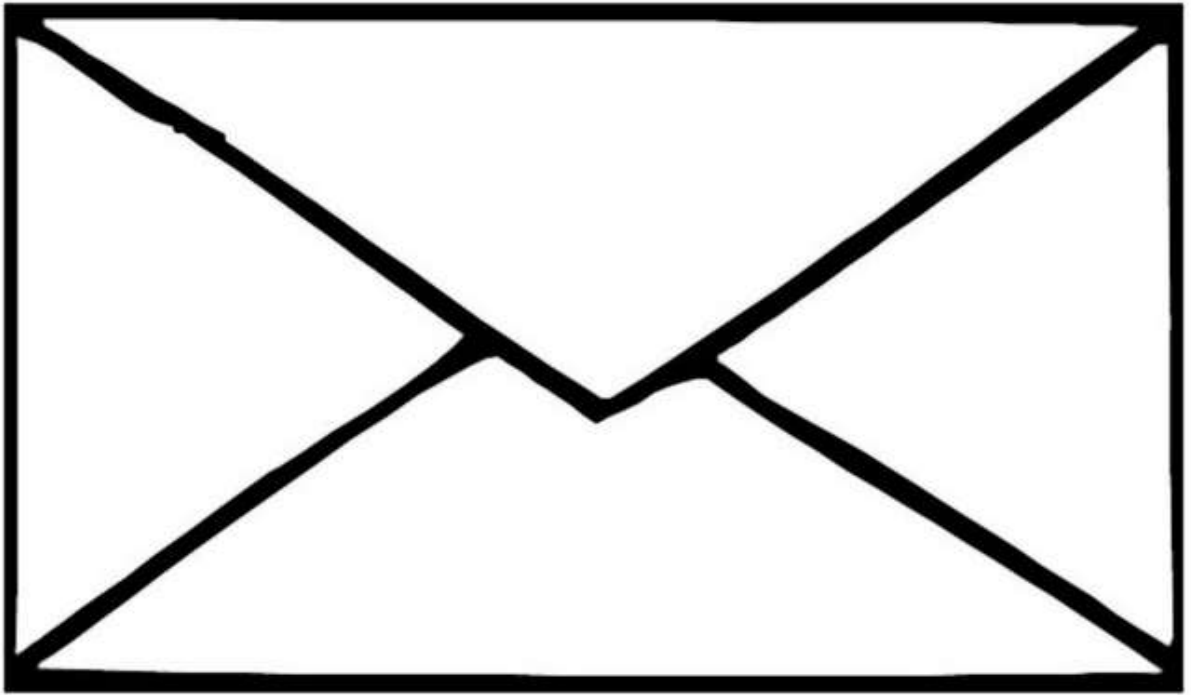

ظروف

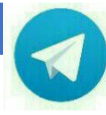

استخدم الصلصال في رسم الحرف :





ع



عين

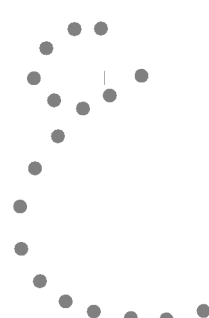
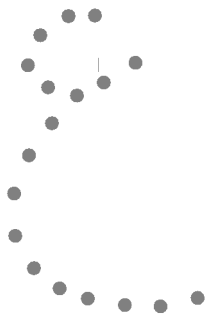
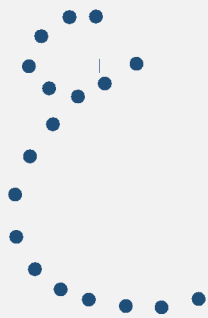



ا



ا



ا

قم بتلوين الرسمة التالية :



عنب

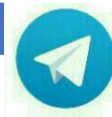

استخدم الصلصال في رسم الحرف :



غ



غراب

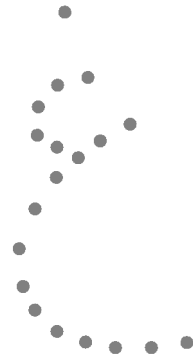
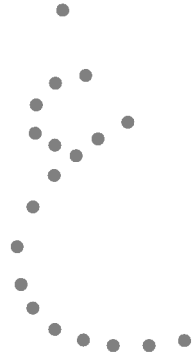



ا



آ



أ

قم بتلوين الرسمة التالية :

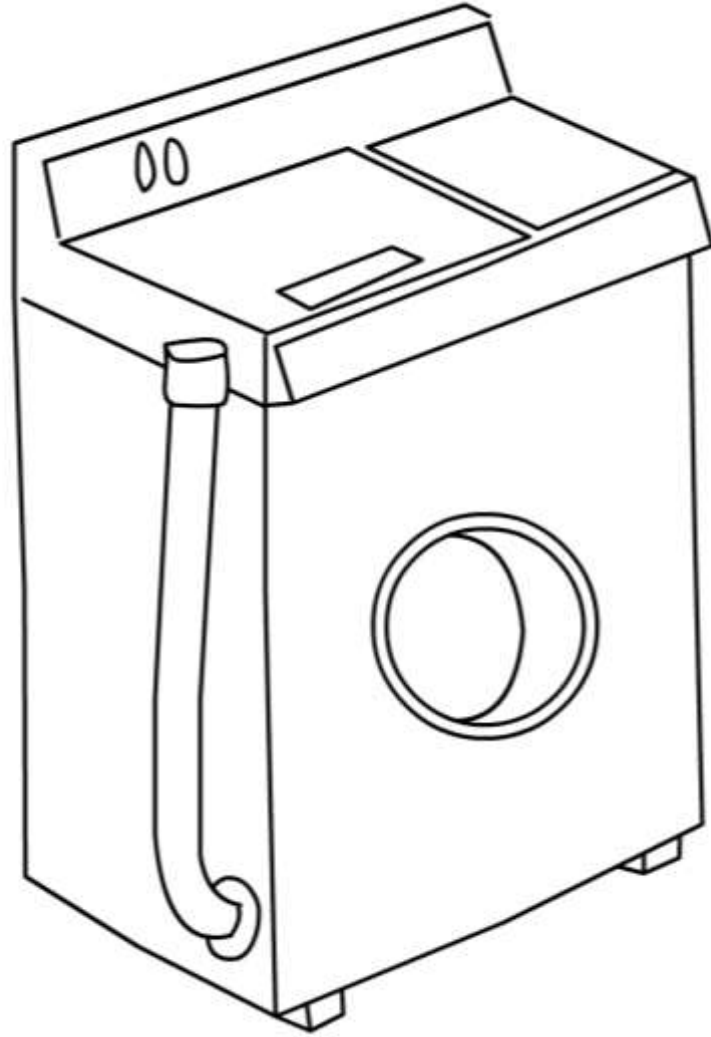

غسالة

استخدم الصلصال في رسم الحرف :

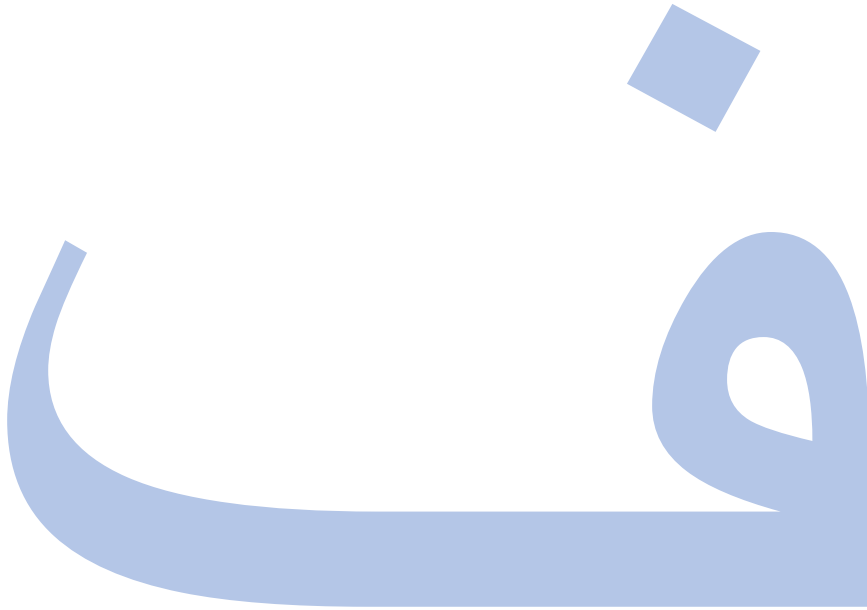



ف



فراولة

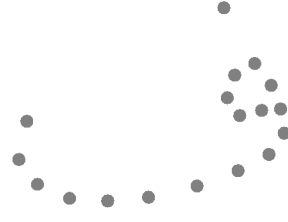
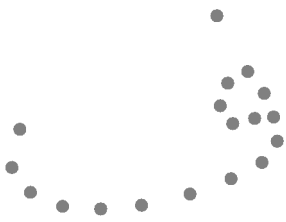



وا



وا



وا

قم بتلوين الرسمة التالية :

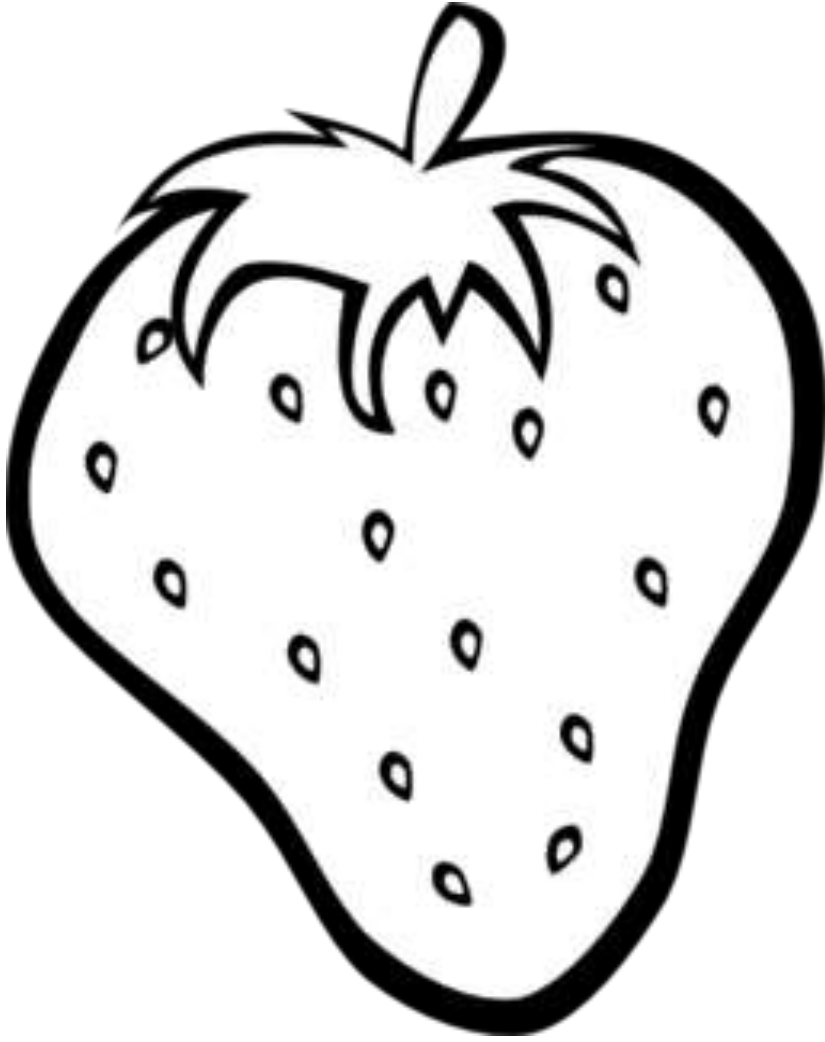

فراولة



استخدم الصلصال في رسم الحرف :



ق



قظ

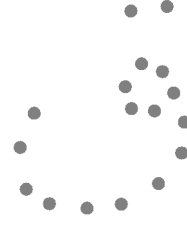
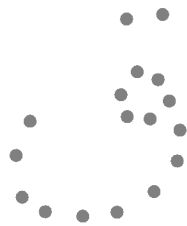



اِفْ



اِفْ



اِفْ

قم بتلوين الرسمة التالية :

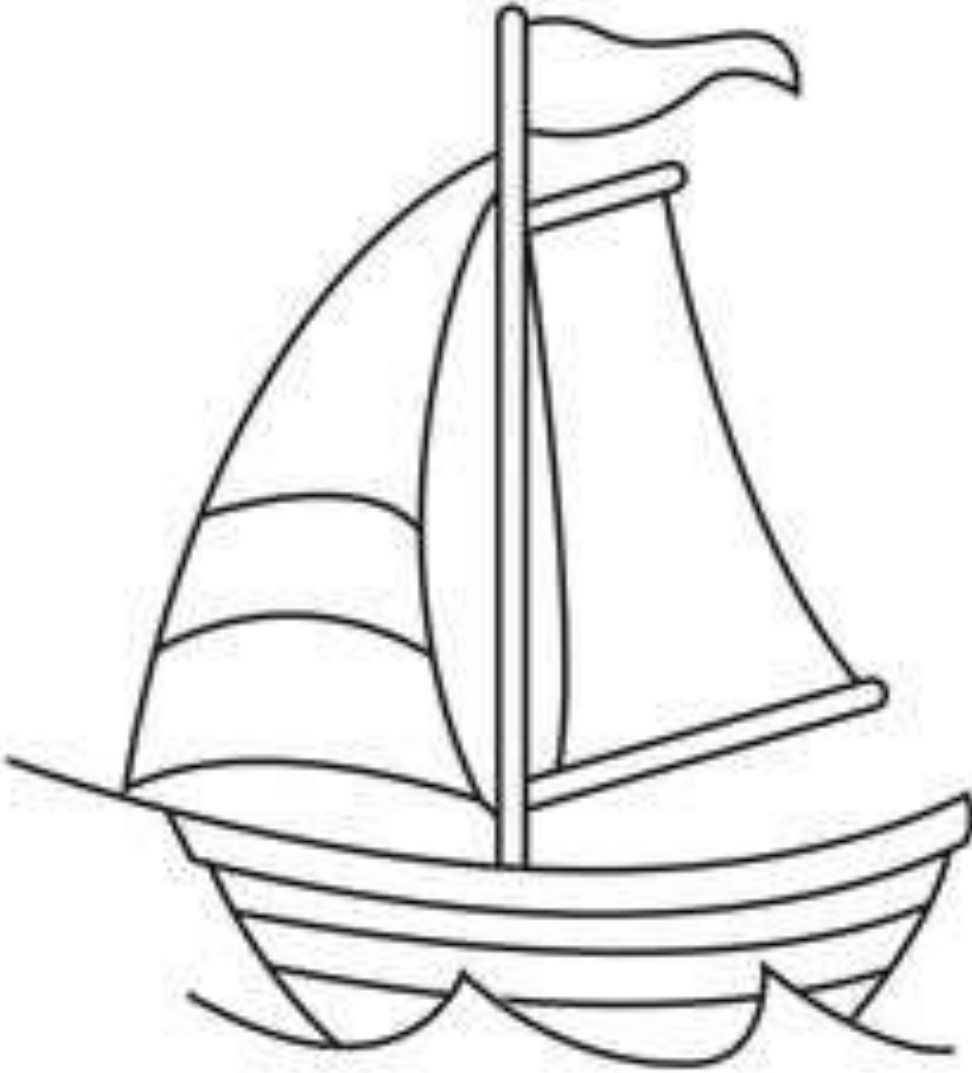

قارب

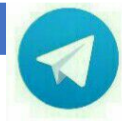

استخدم الصلصال في رسم الحرف :





أ



كتاب

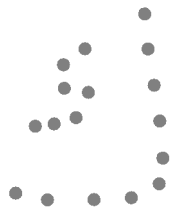



أ



إ



ؤ

قم بتلوين الرسمة التالية :

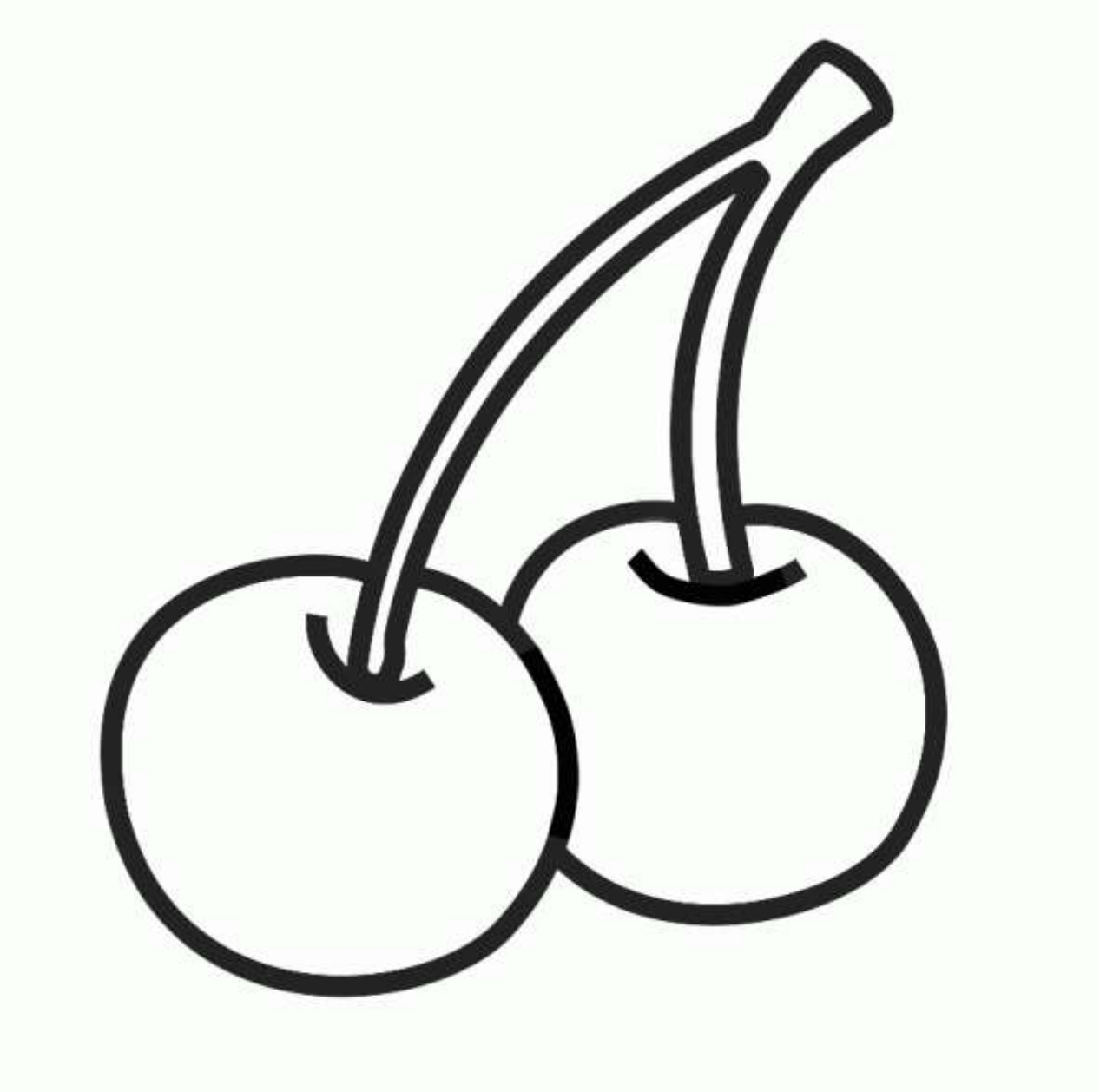

كوز

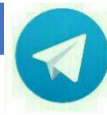

استخدم الصلصال في رسم الحرف :

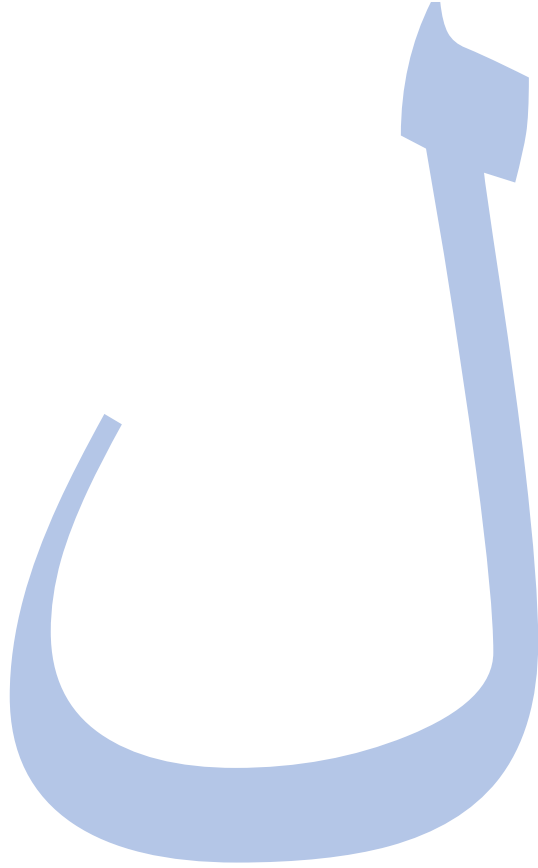

ل



ليمون





أ



ب



و

قم بتلوين الرسمة التالية :

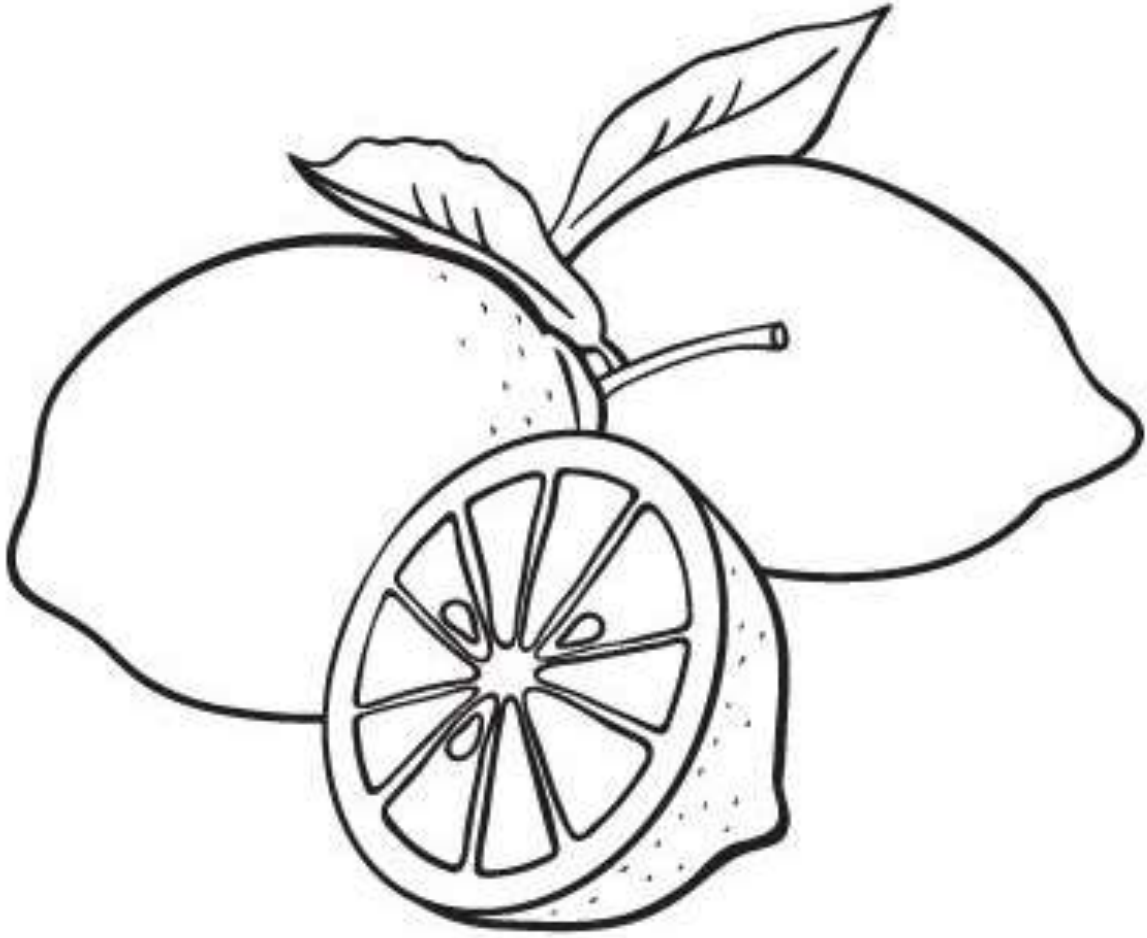

ليمون



استخدم الصلصال في رسم الحرف :





ح



ملعقة





ا  
ح



ح  
ا



ه  
ح

قم بتلوين الرسمة التالية :

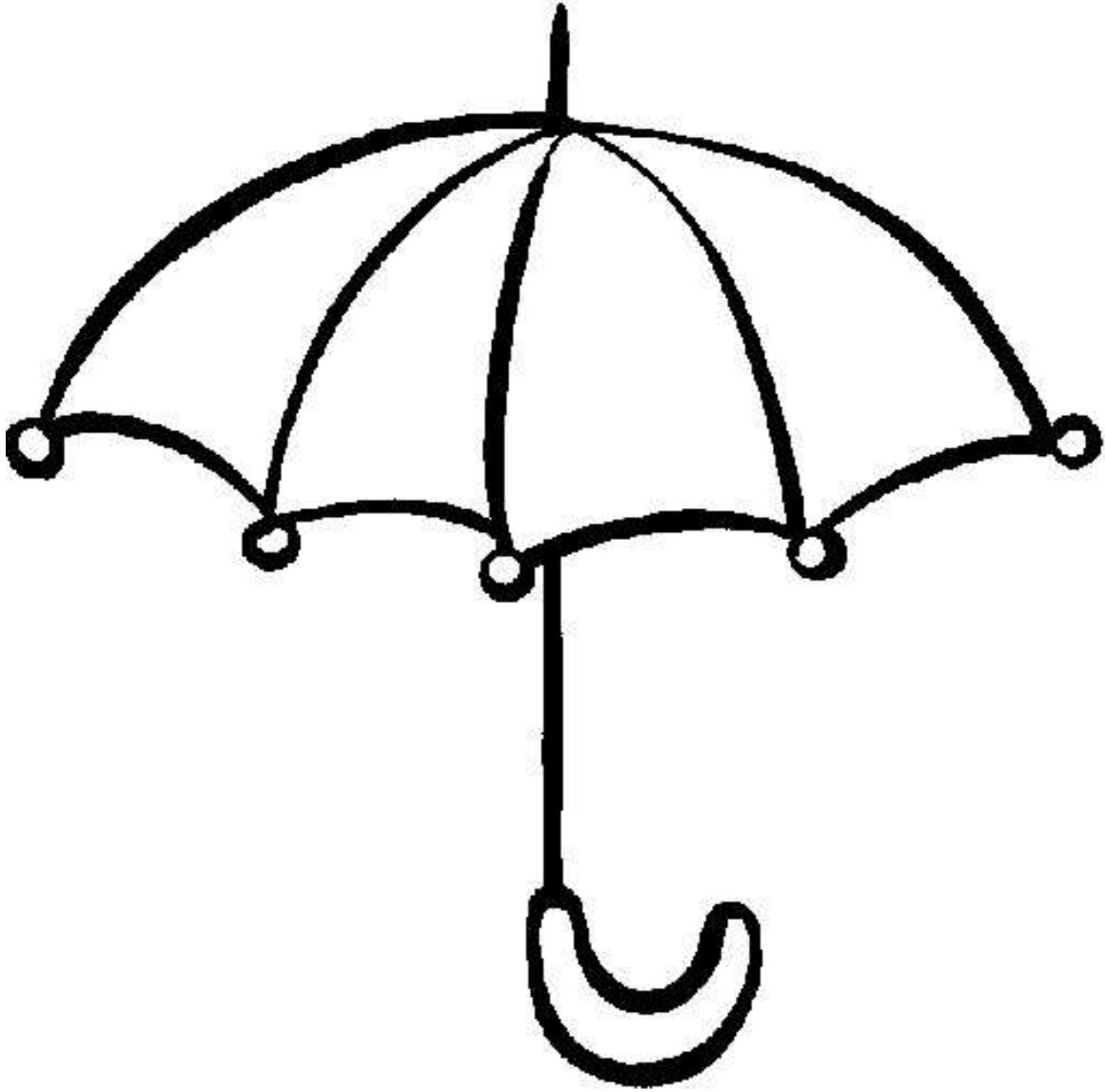

مظلة

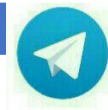

استخدم الصلصال في رسم الحرف :



ن



نمر





ا



ب



م

قم بتلوين الرسمة التالية :

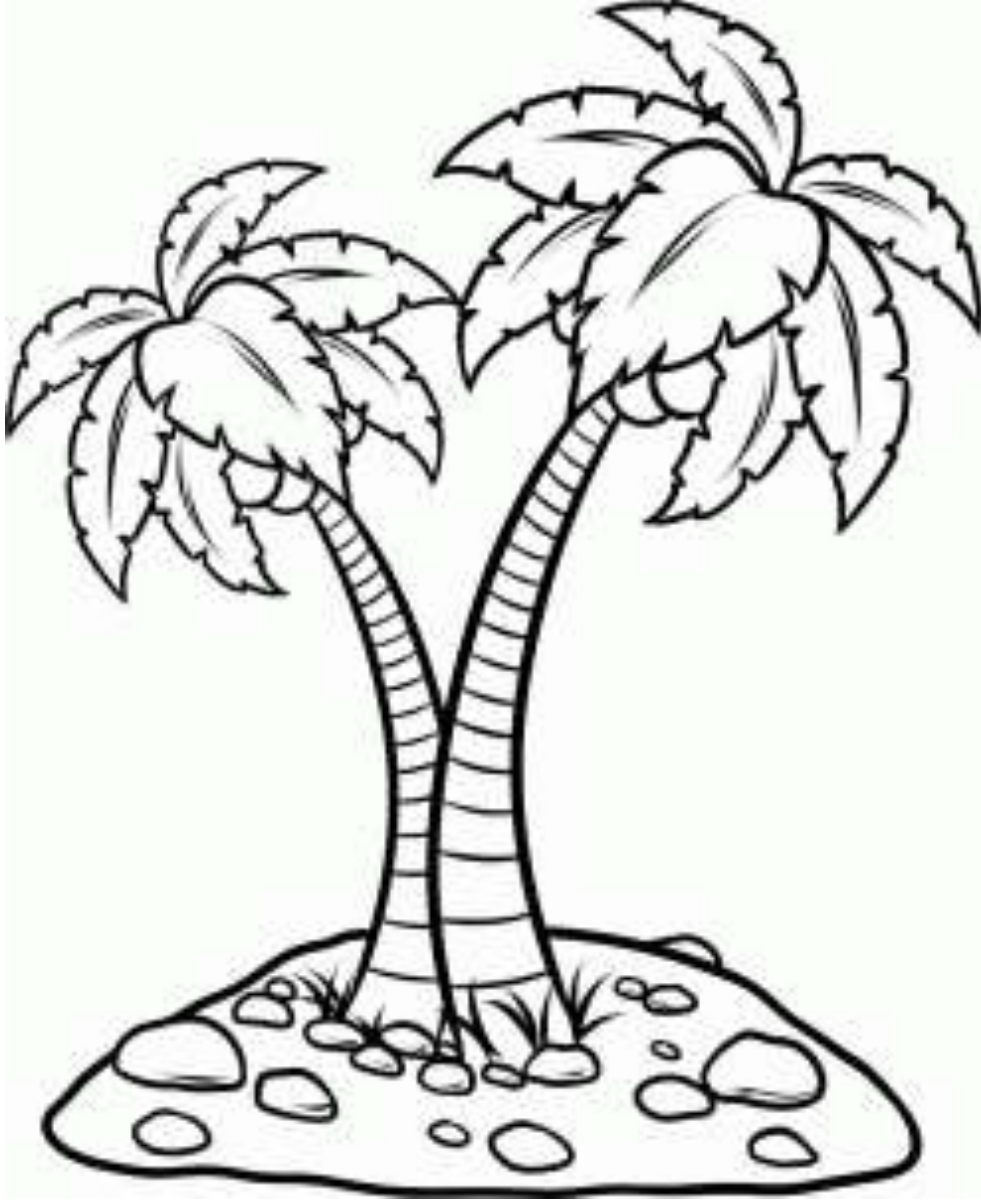

نخلة

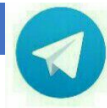

استخدم الصلصال في رسم الحرف :

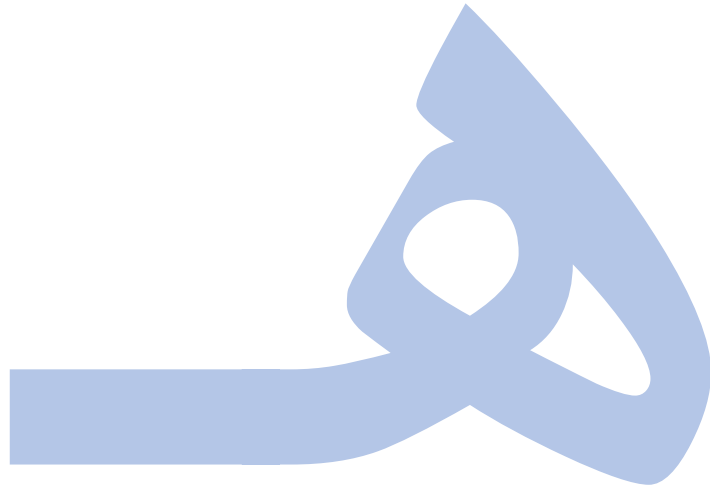



ه



هدية

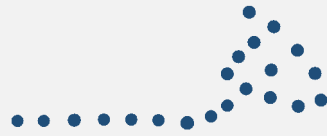
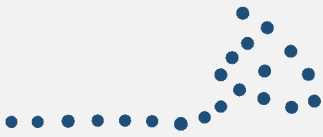



ها



ها



ها

قم بتلوين الرسمة التالية :



هدية

استخدم الصلصال في رسم الحرف :



و



وحيد القرن





ا  
و



و  
ا



و  
و

قم بتلوين الرسمة التالية :

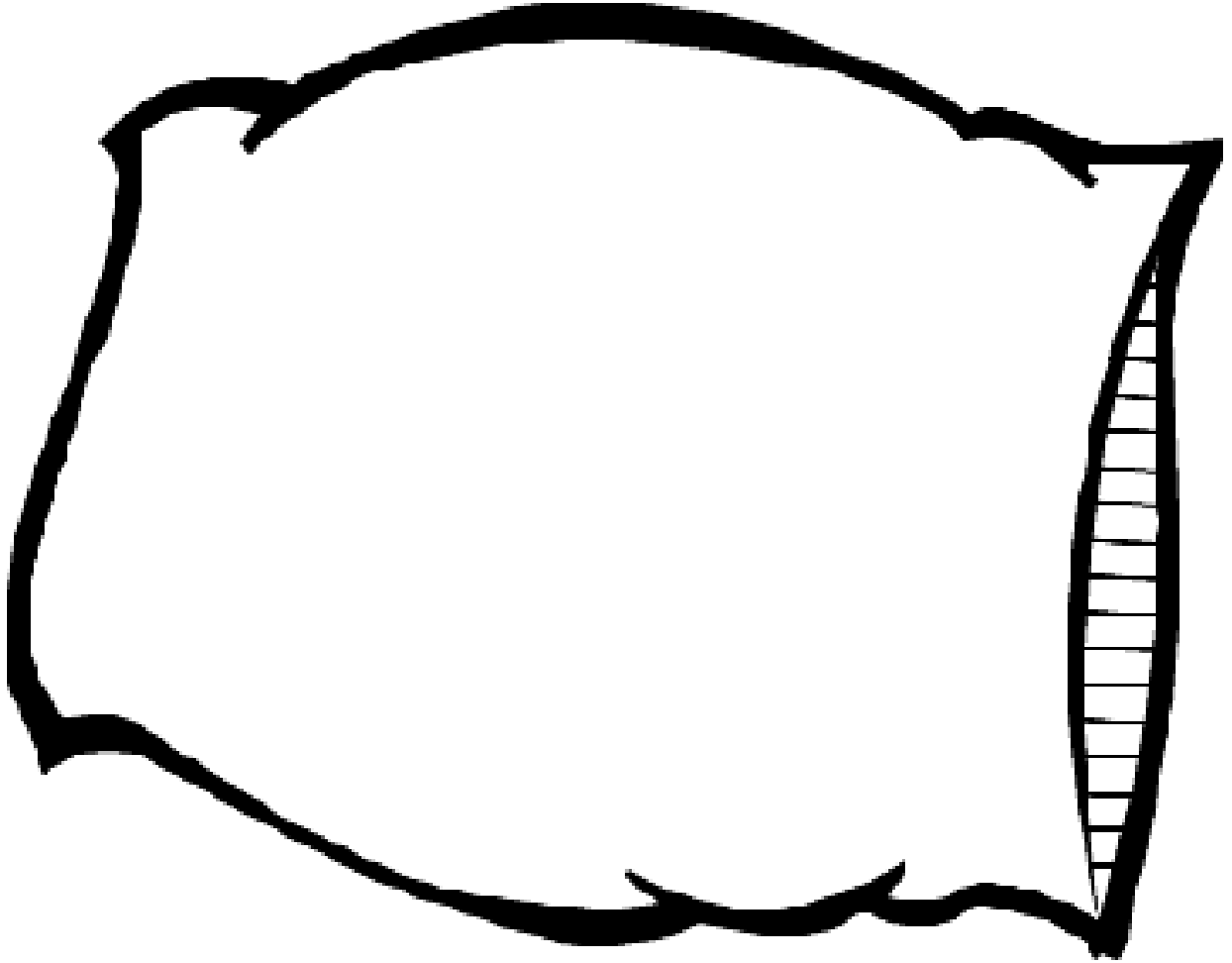

وسادة

استخدم الصلصال في رسم الحرف :





ي



ي

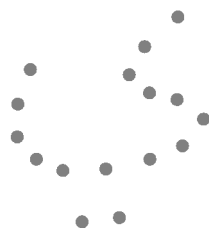
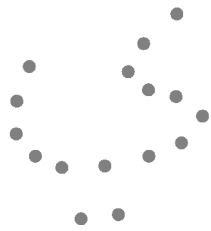
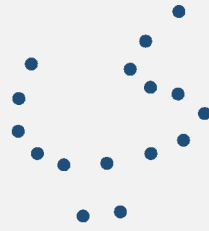



يا



يا



يا

قم بتلوين الرسمة التالية :

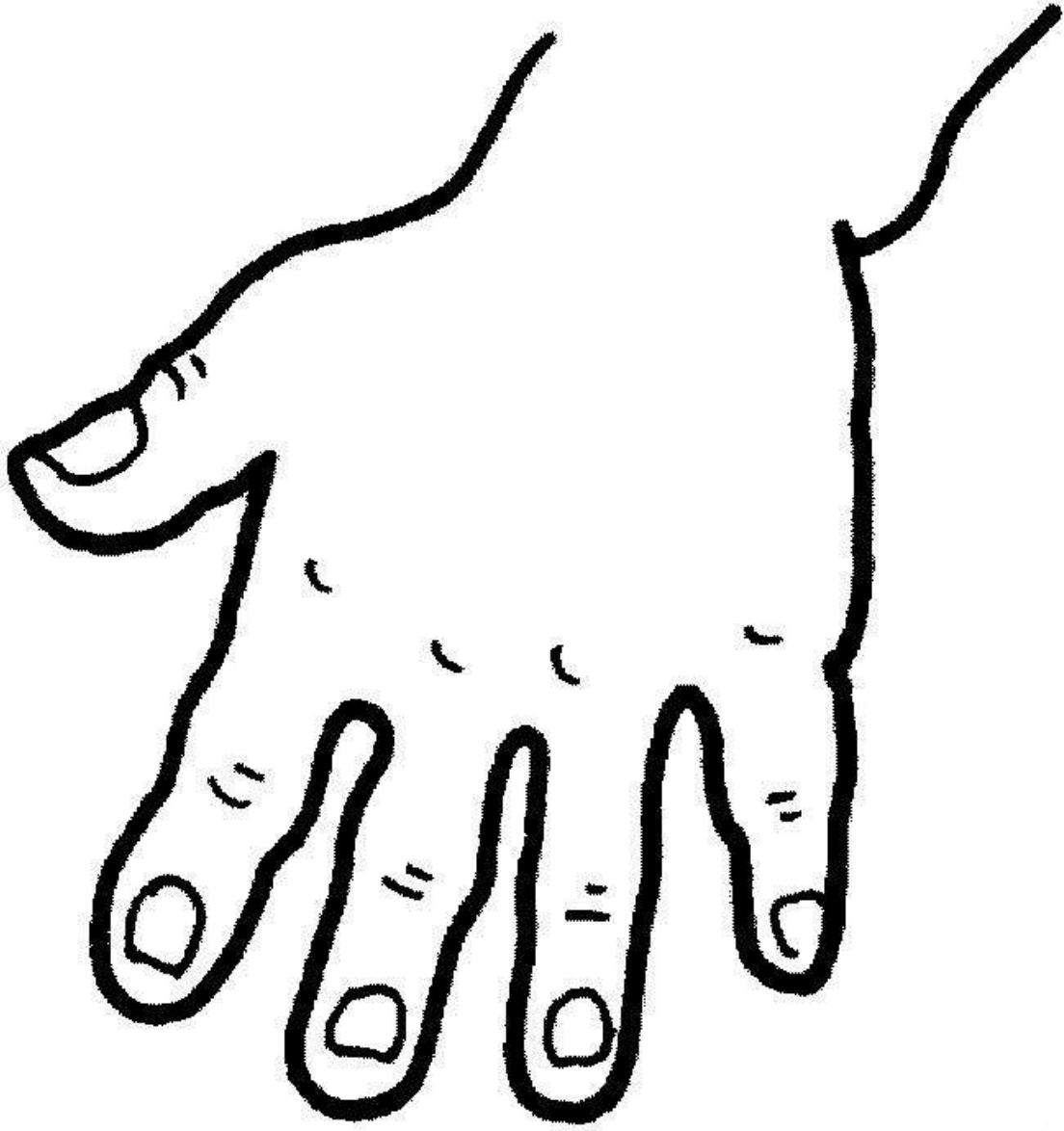

يد

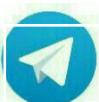



 **@Arabic\_Books**