



مدونة المناهج السعودية

<https://eduschool40.blog>

الموقع التعليمي لجميع المراحل الدراسية

في المملكة العربية السعودية

لون

حرف ألف

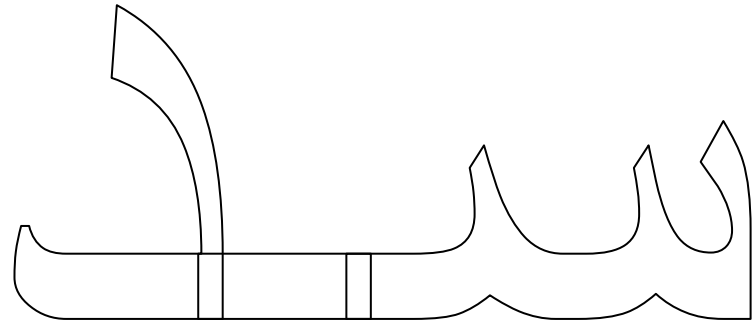
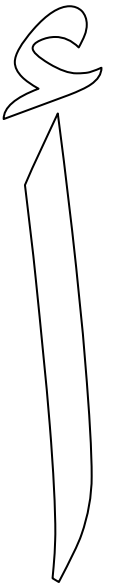
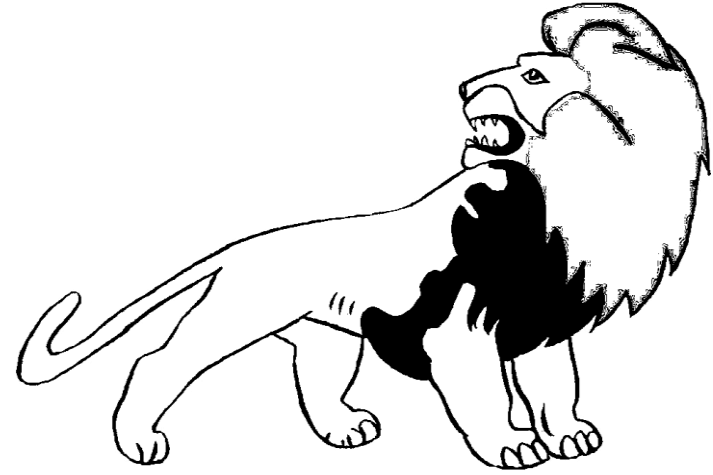
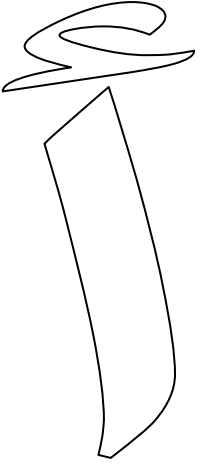

أ

أ

أسد

لون

حرف باء

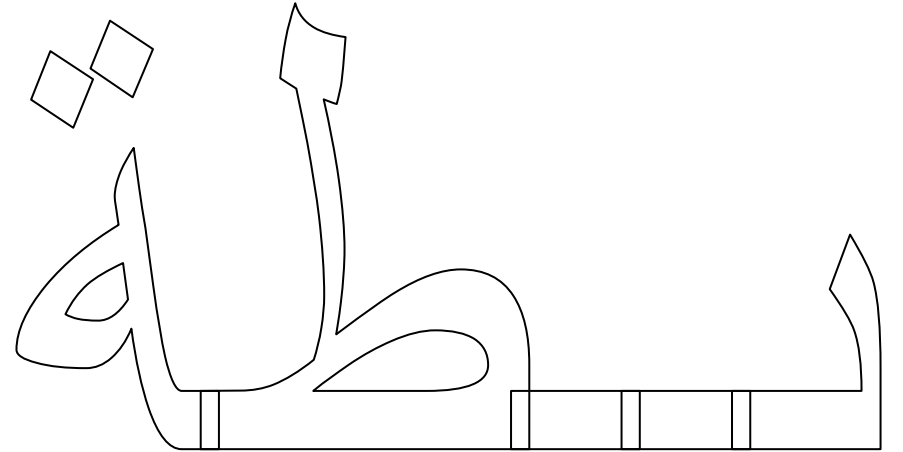
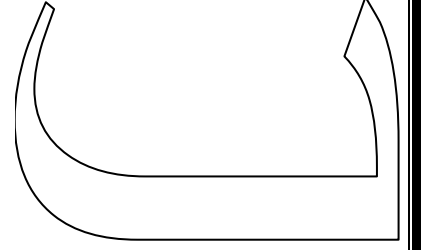
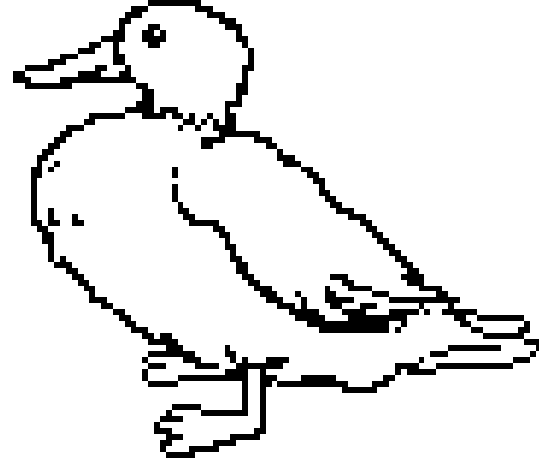

ب

با

بطة

لون

حرف تاء

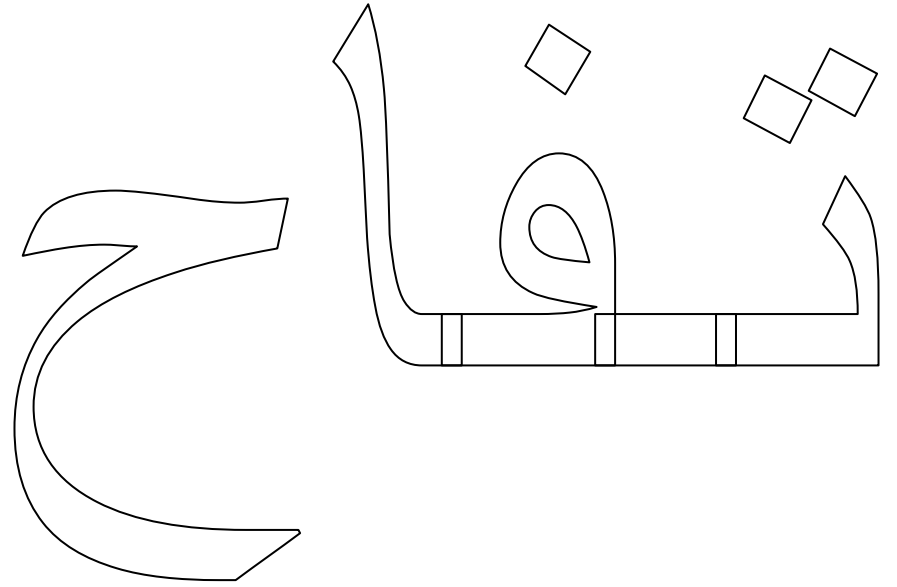
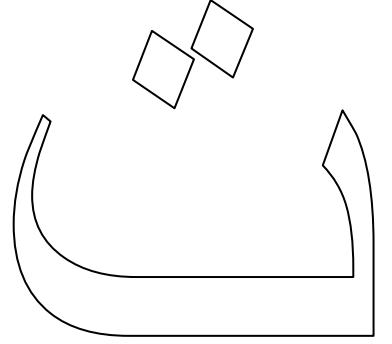
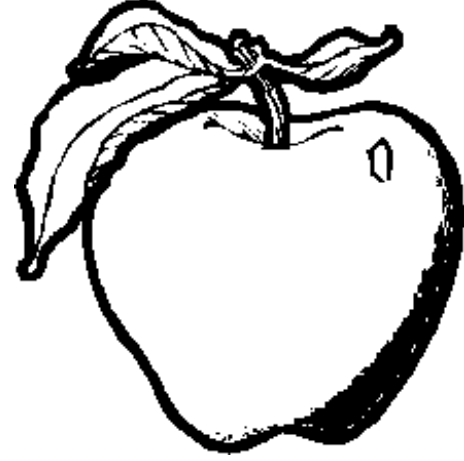

ت

ت

تفاح

لون

حرف ثاء

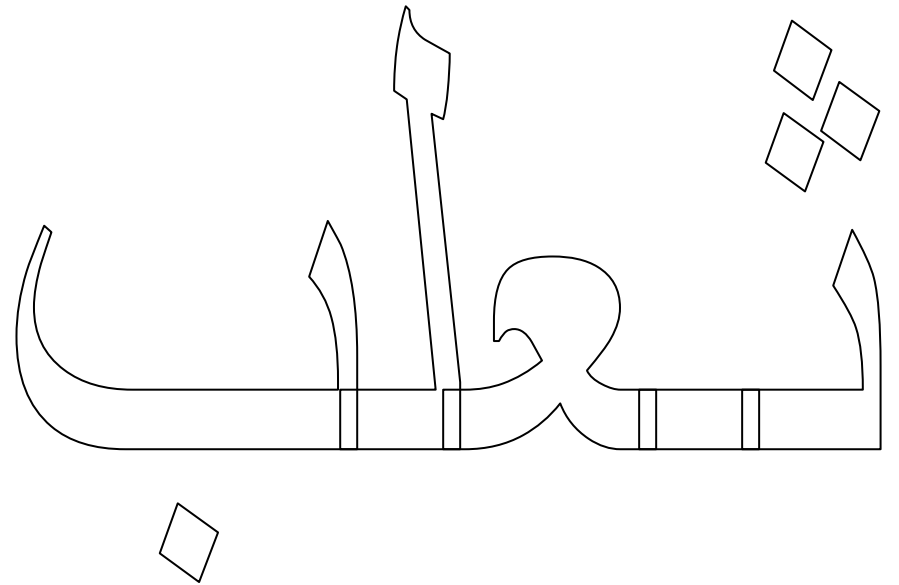
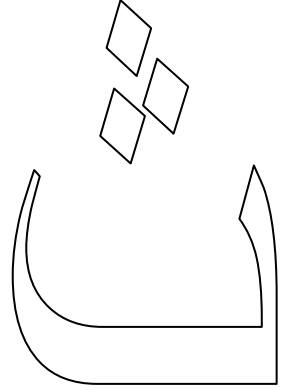
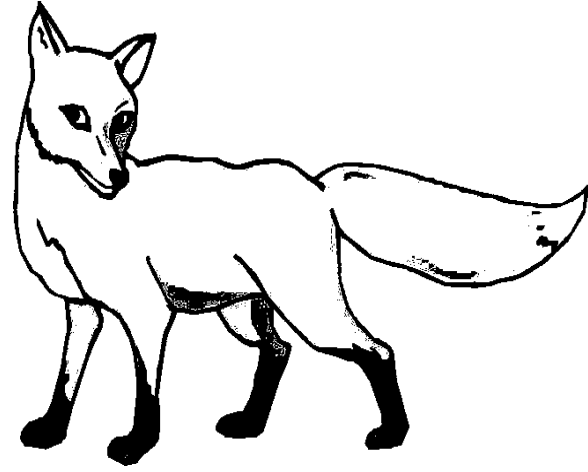

ث

ث

ثعلب

لون

حرف جيب

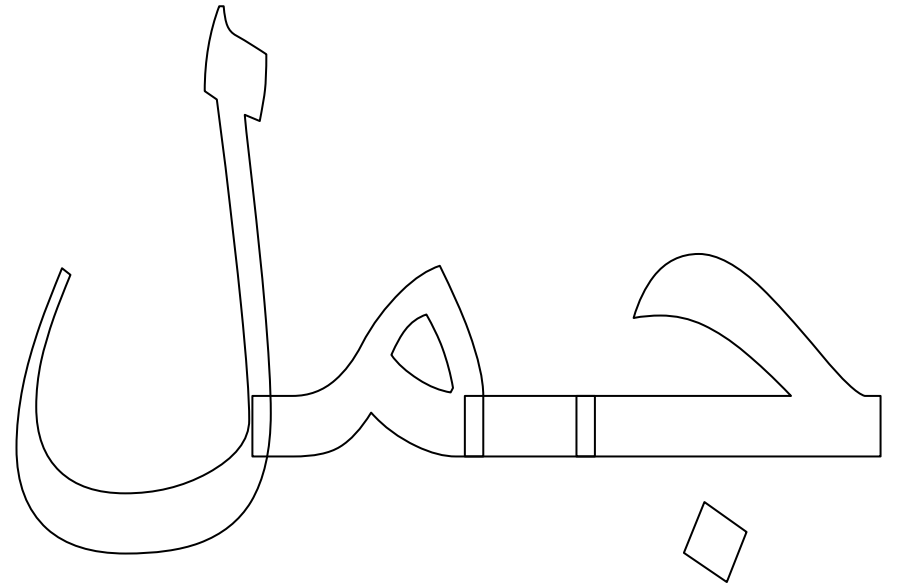
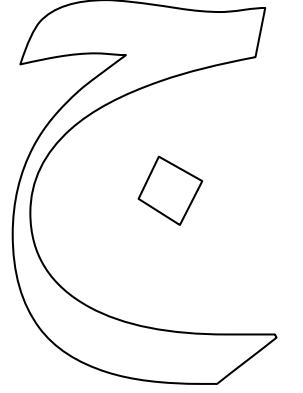
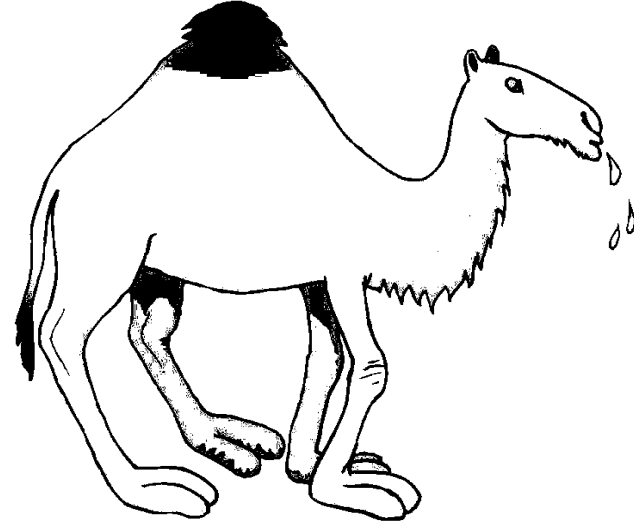

ج

ج

جمل

لون

حرف حاء

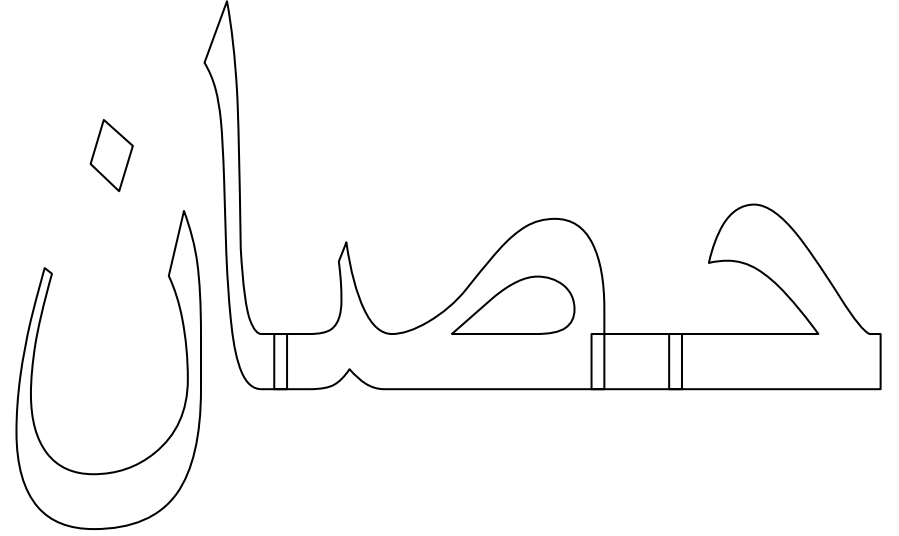
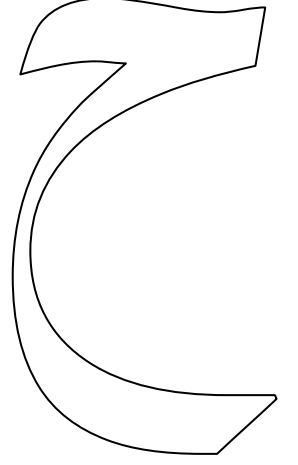

ح

ح

حصان

حروف

خ

ح

حرف خاء

لون

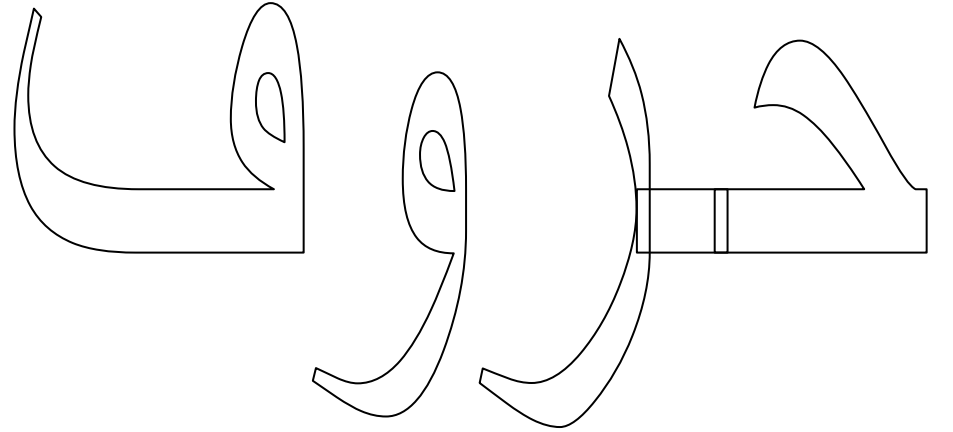
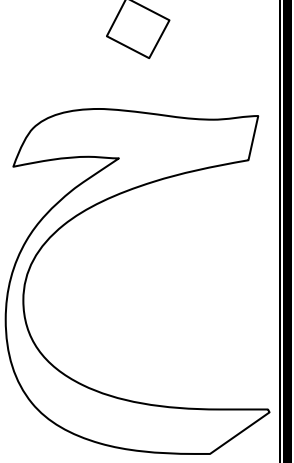
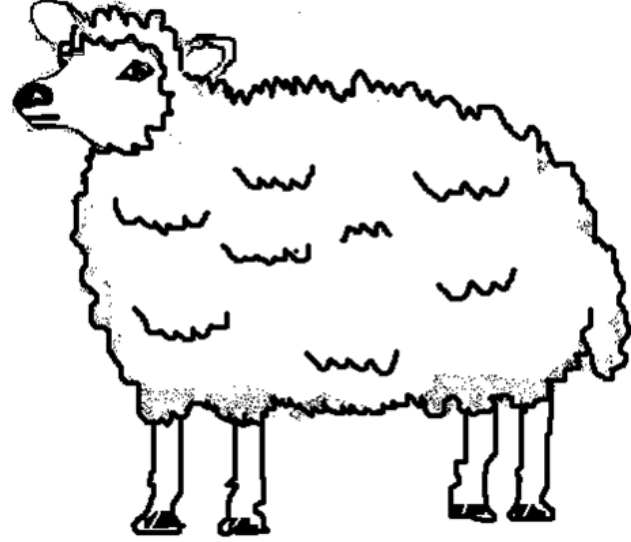

نون

حرف دال

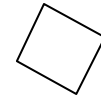
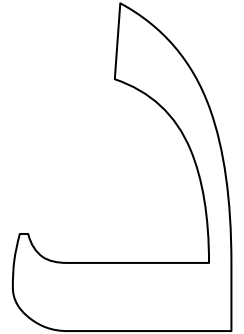
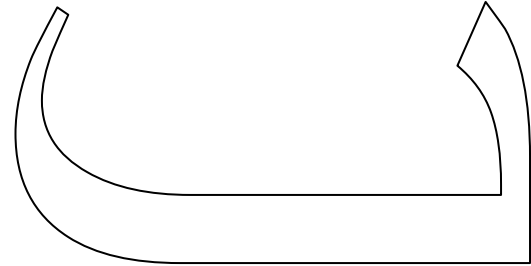
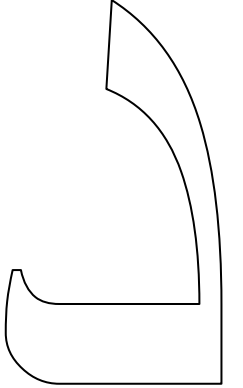
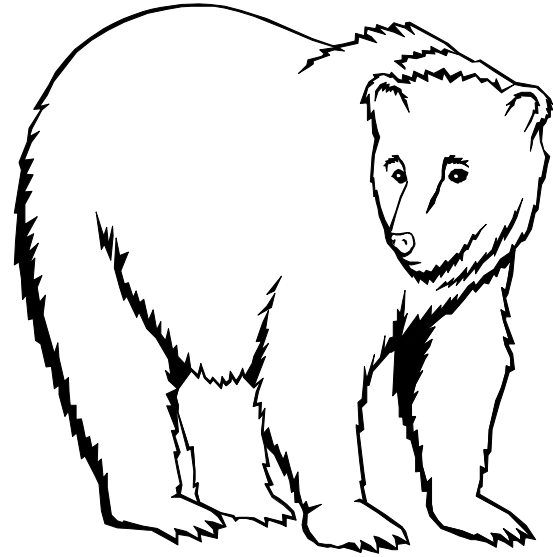

د

د

دب

لون

حرف ذال

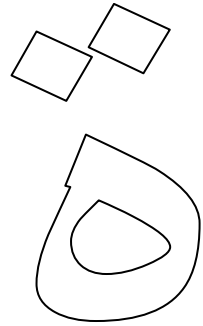
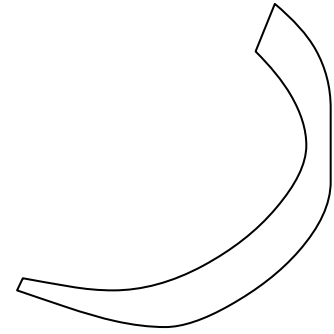
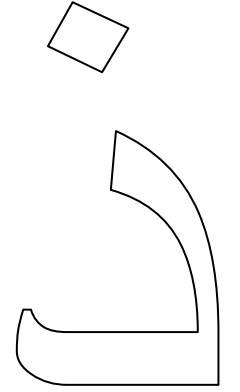
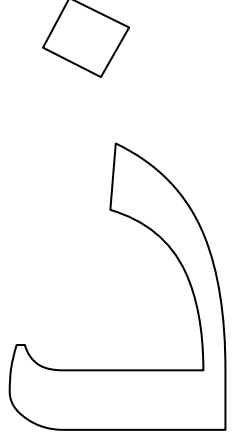
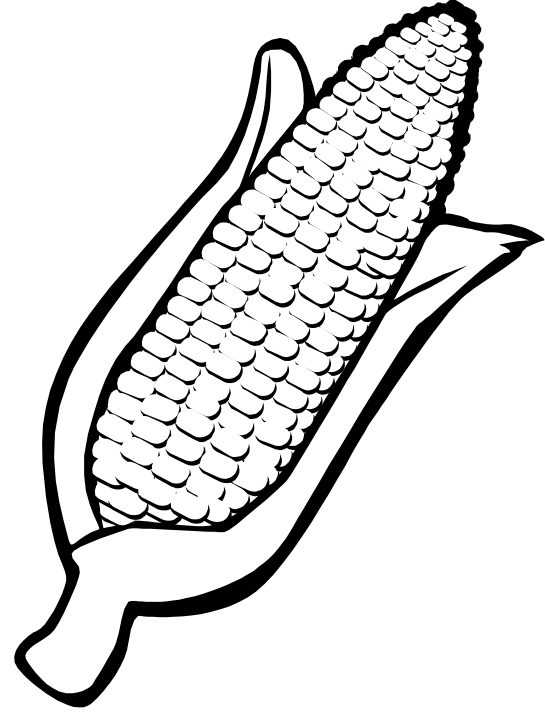

ذ

ذ

ذرة

لون

حرف راء

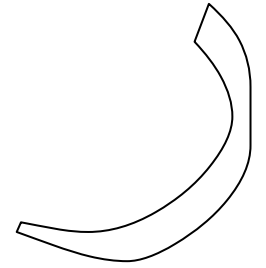
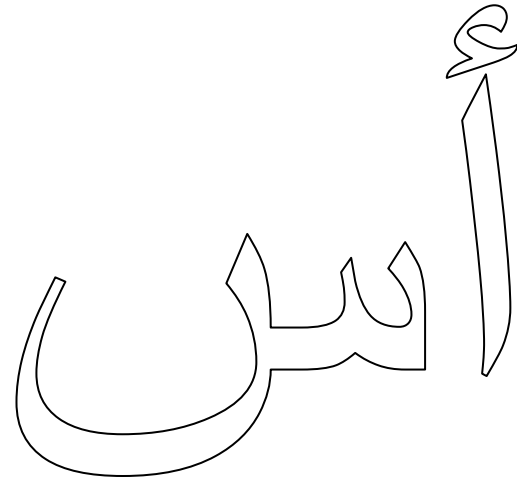
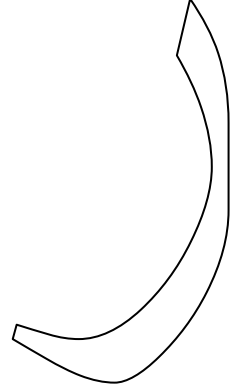

ر

ر

رأس

زرافة

ز

ز

حرف زای

لون

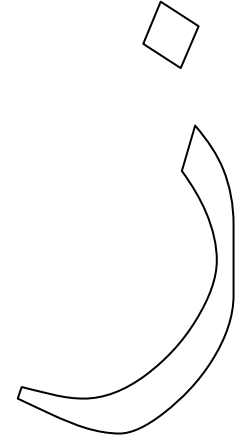
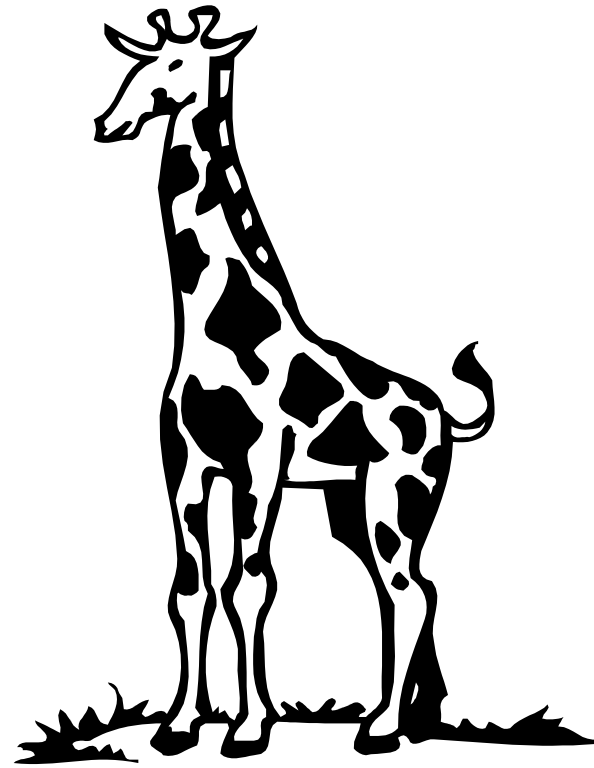

زرافة

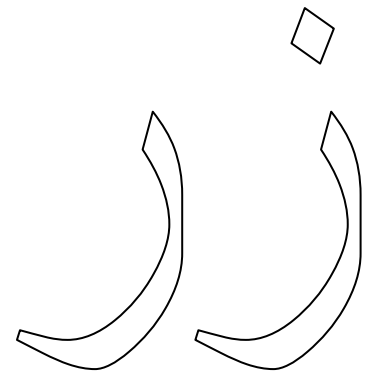

لون

حرف السين

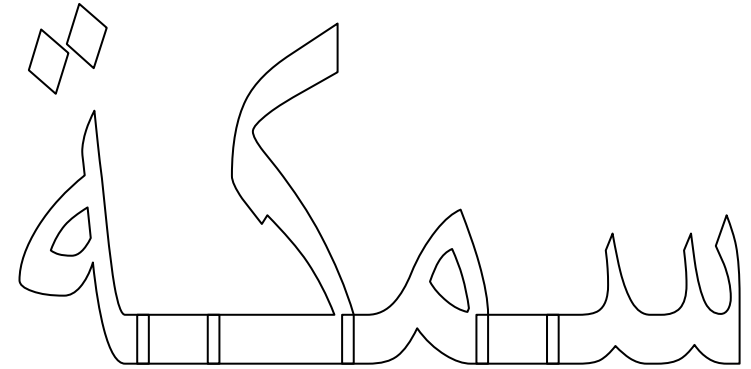
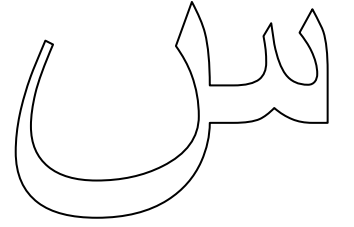
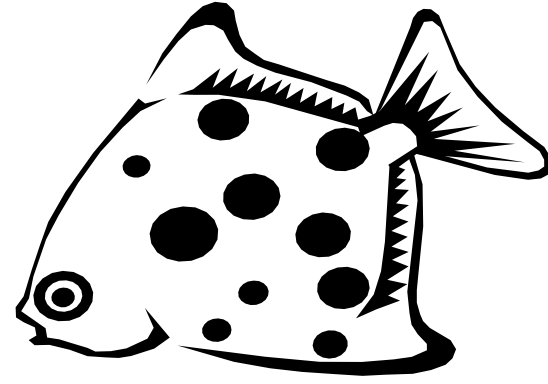

س

س

سمكة

لون

حرف الشين

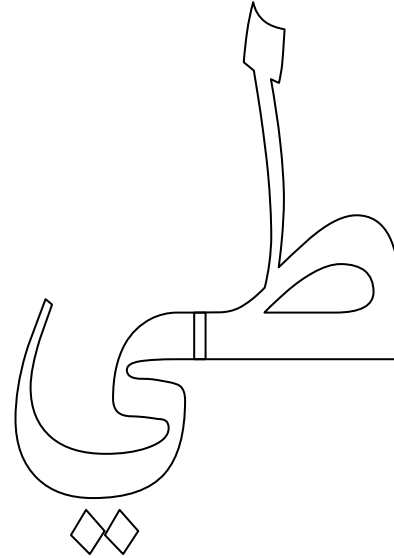
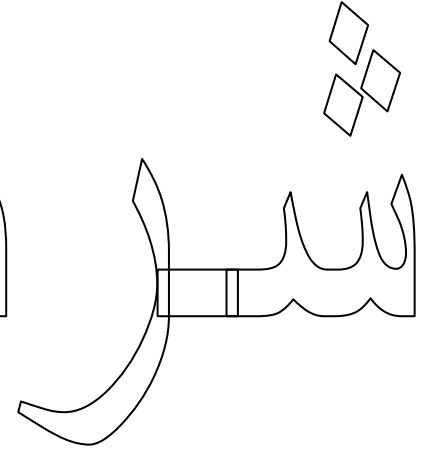
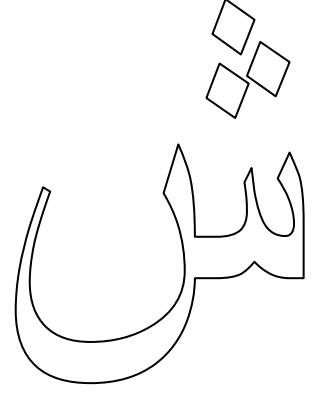

ش

ش

شرطي

لون

حرف الصاد

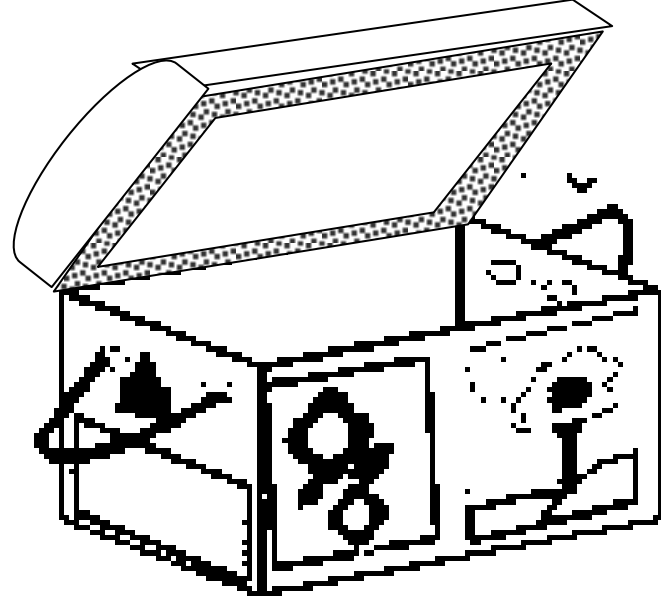
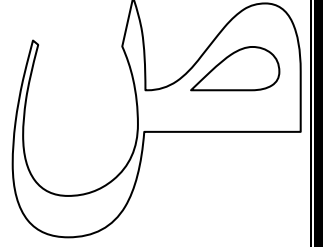

صندوق

ص

ص

صندوق

لون

حرف الضاد

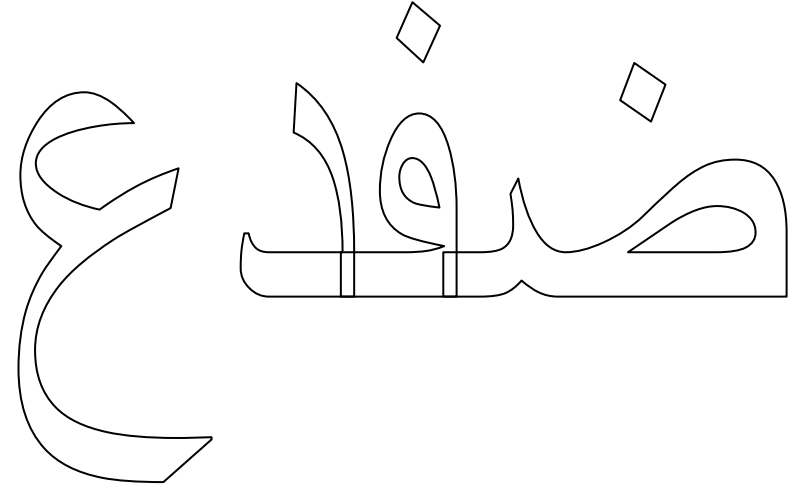
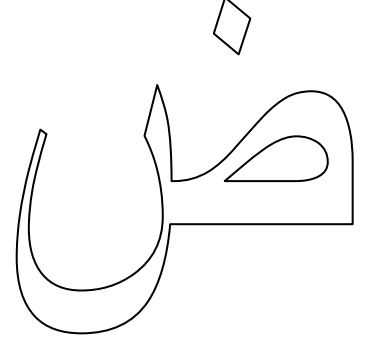
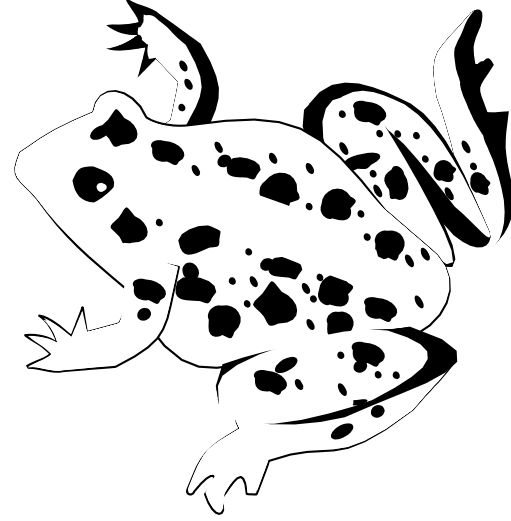

ض

ض

ضفدع

لون

حرف الطاء

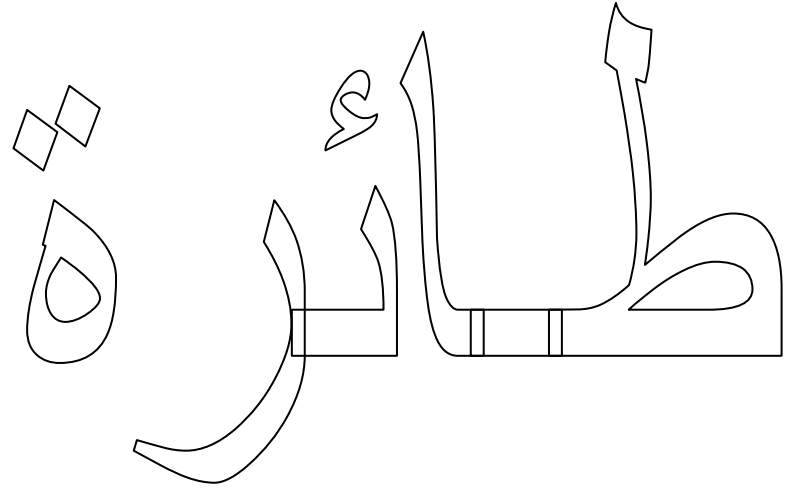
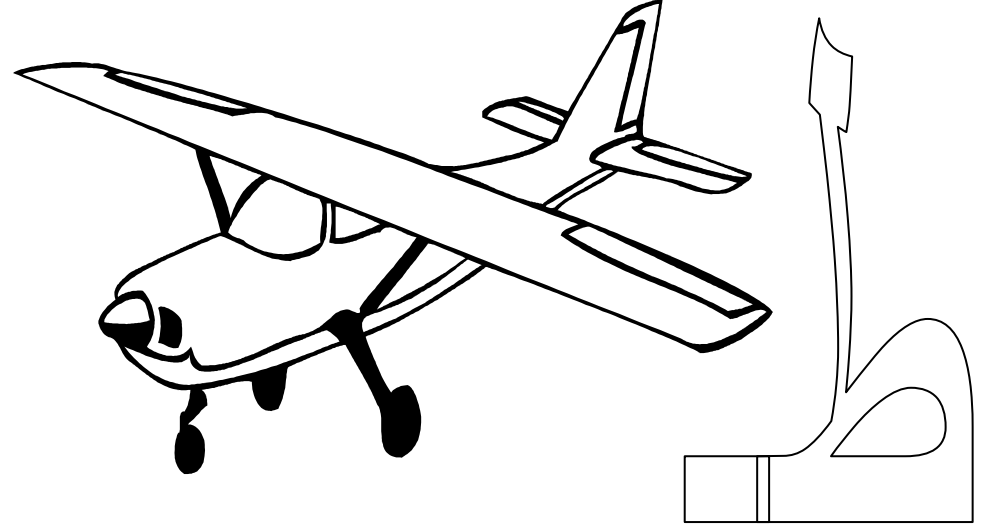

ط

ط

طائرة

لون

حرف الظا

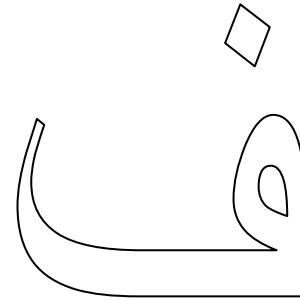
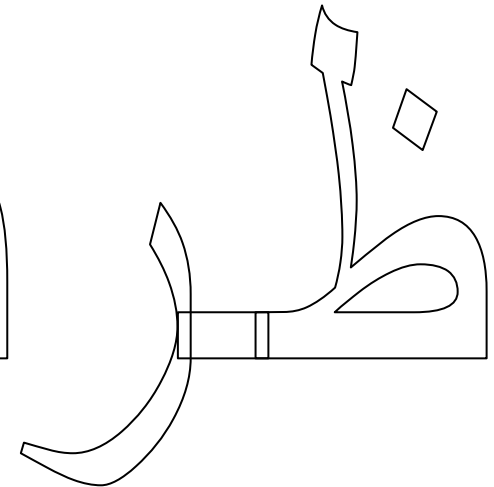
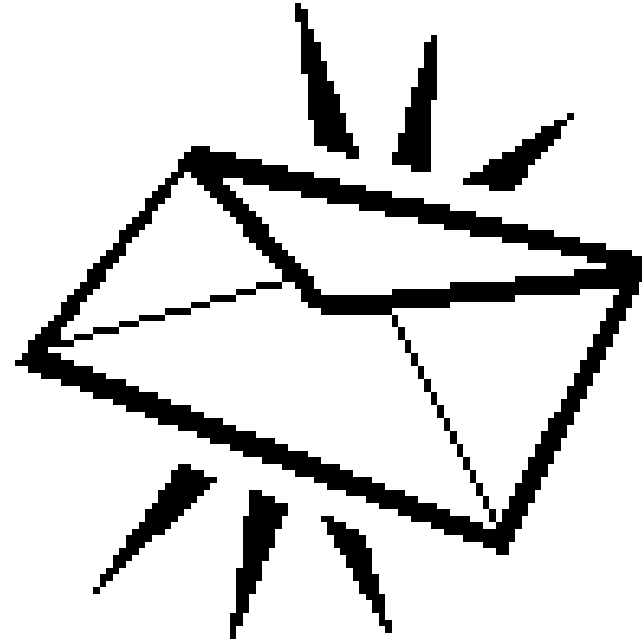
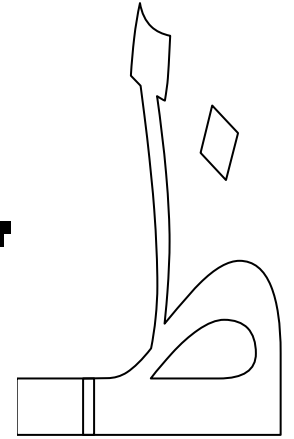

ظ

ظ

ظرف

نون

حرف العين

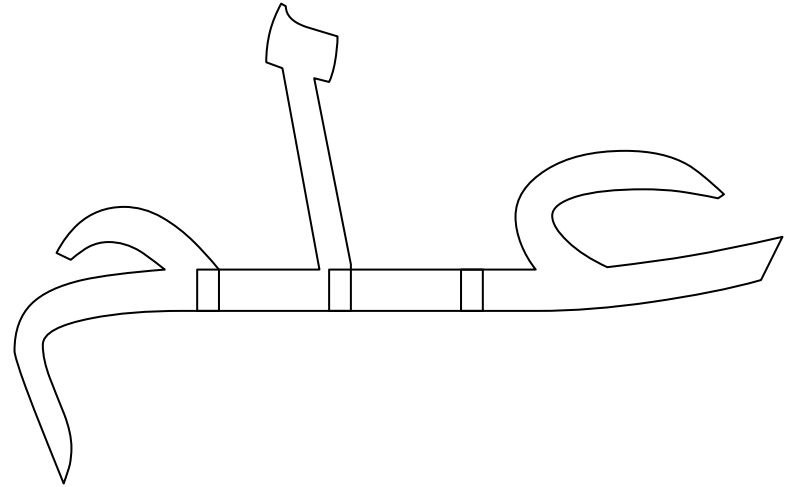
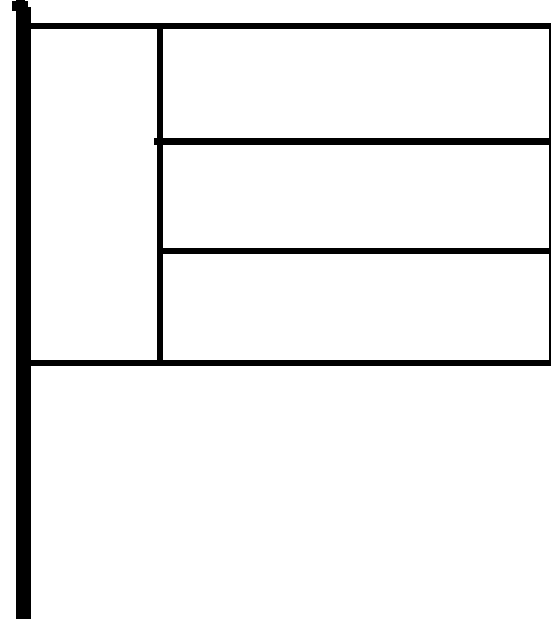
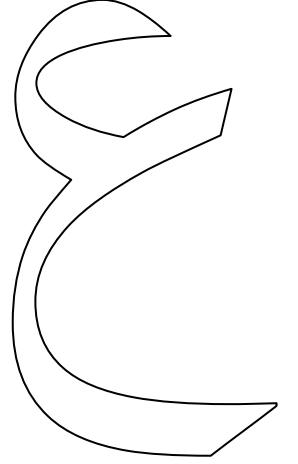

ع

ط

علم

لون

حرف الغين

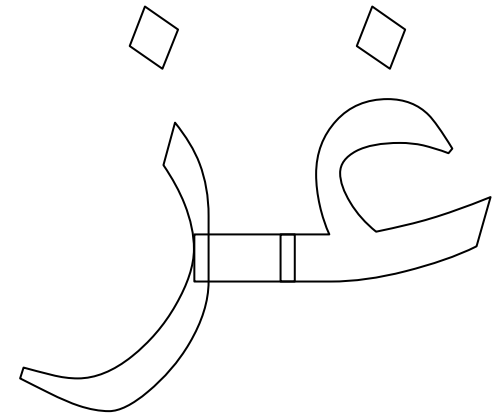
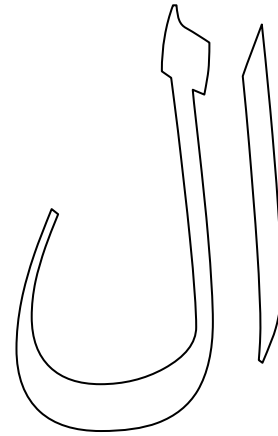
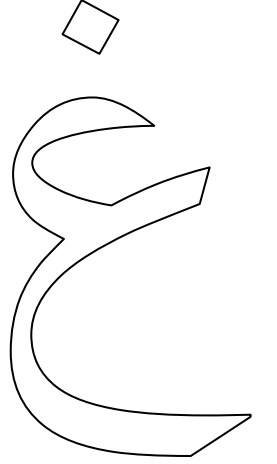
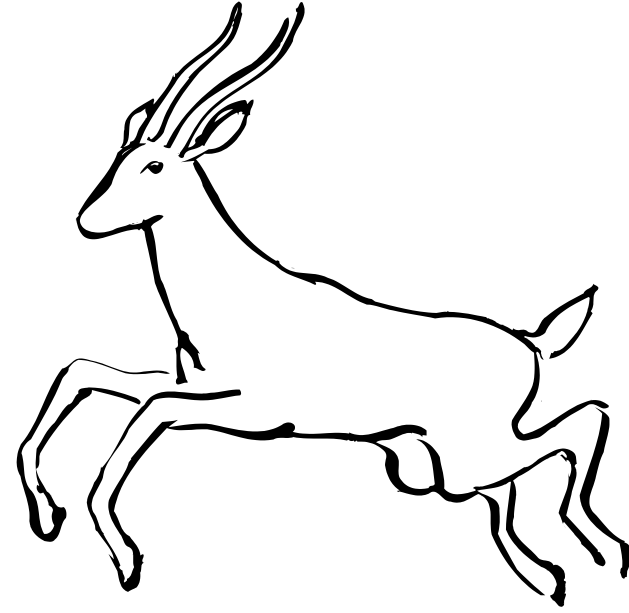

غ

ظ

غزال

لون

حرف الفاء

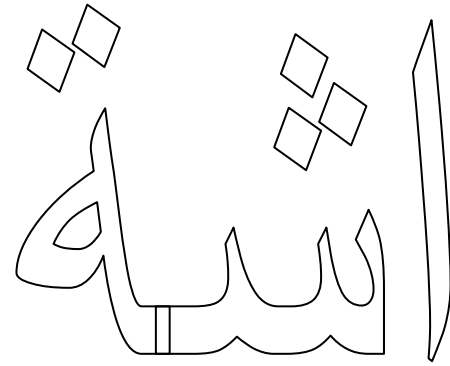
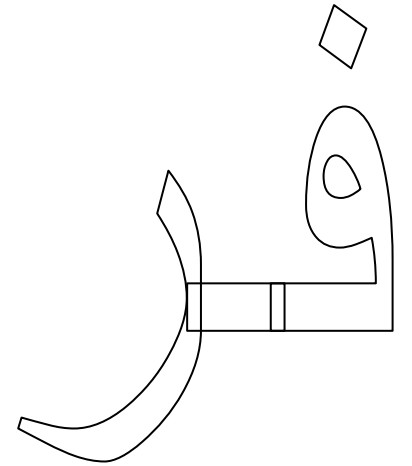
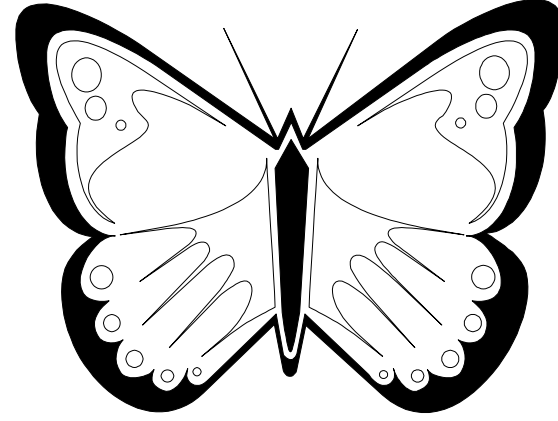
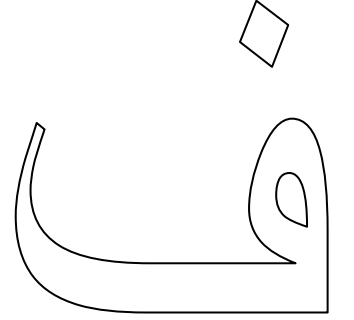

ف

فا

فراشة

لون

حرف القاف

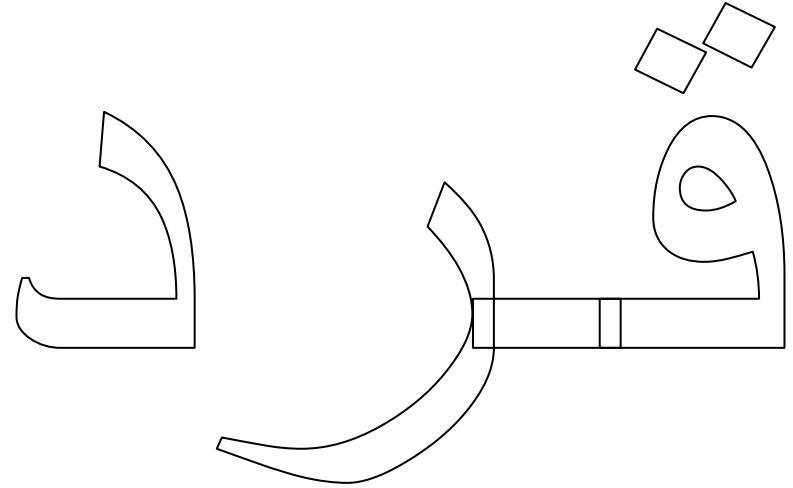
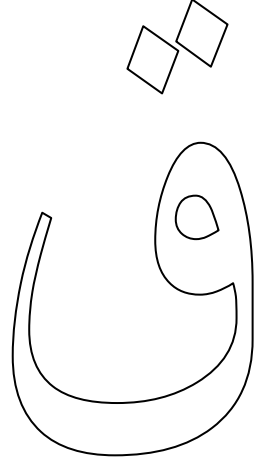

ق

قا

قرا

لون

حرف الكاف

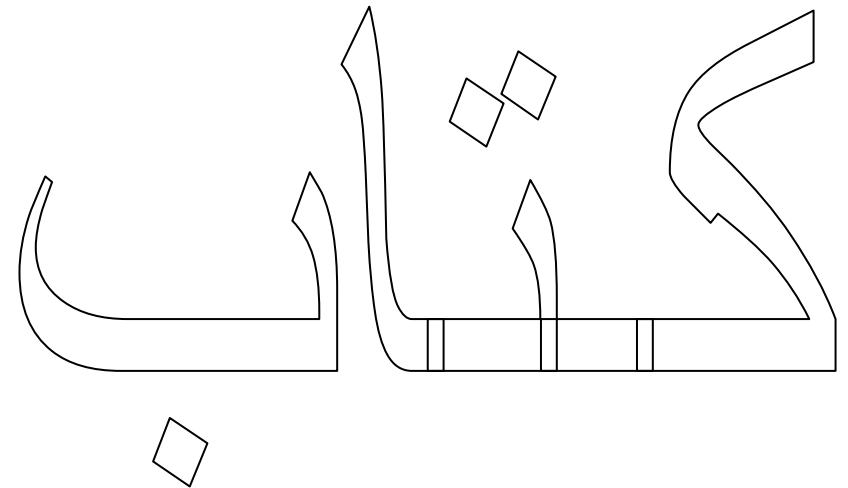
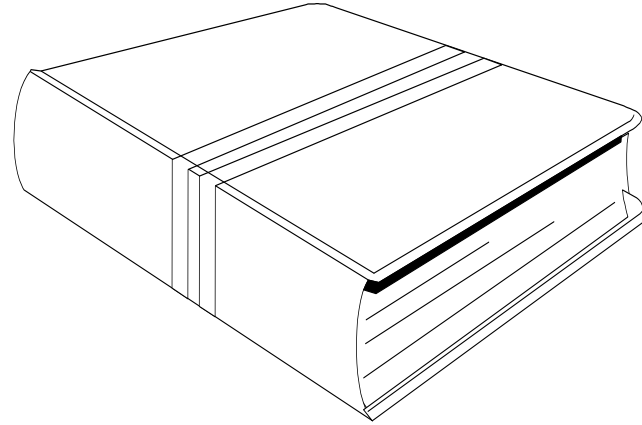
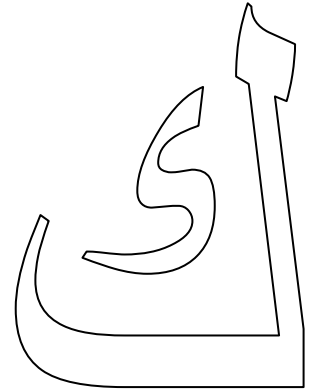

ك

ك

كتاب

نون

حرف اللام

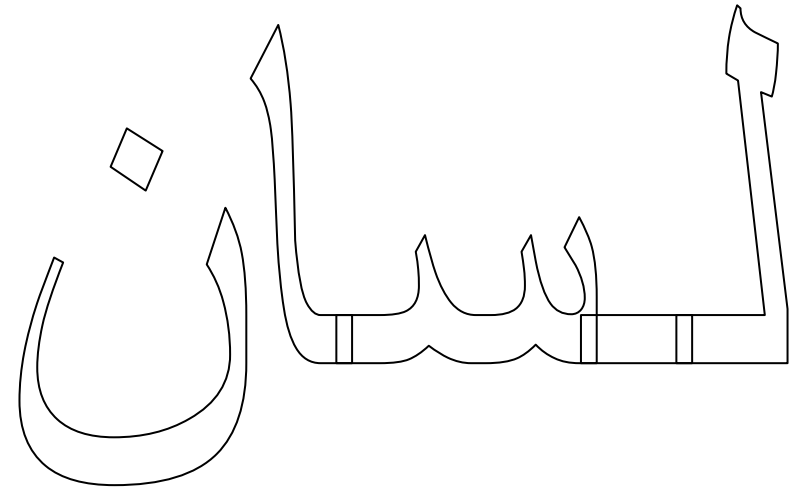
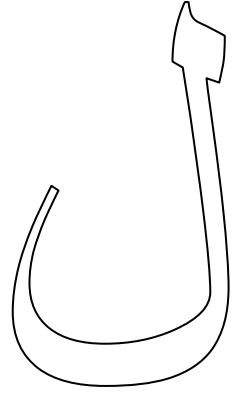

ل

ل

لسان

لون

حرف الميم

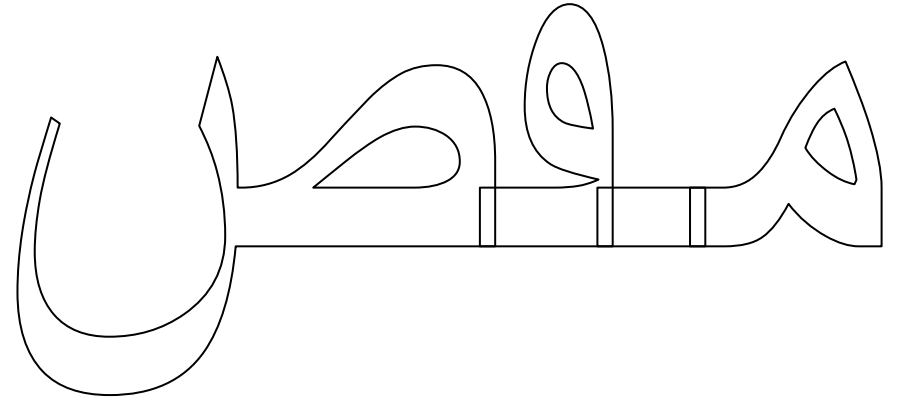
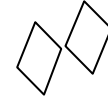
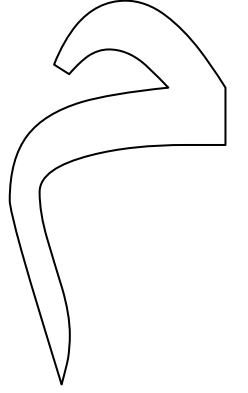

ح

م

مقص

نجمه

نا

ن

حرف نون

نون

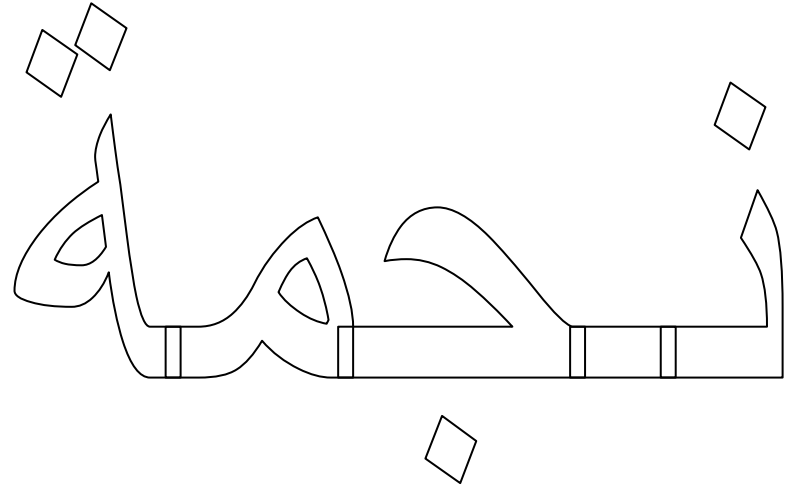
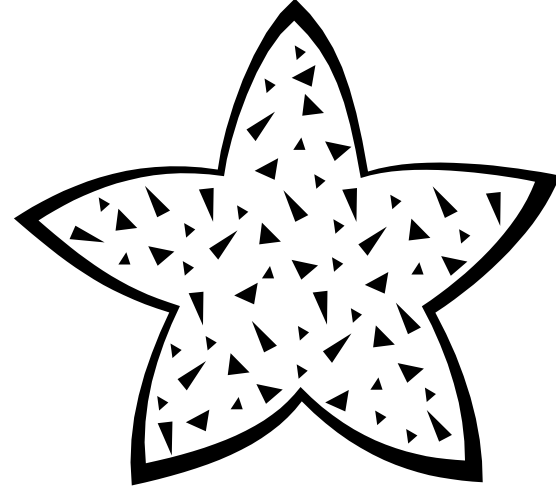

لون

حرف هاء

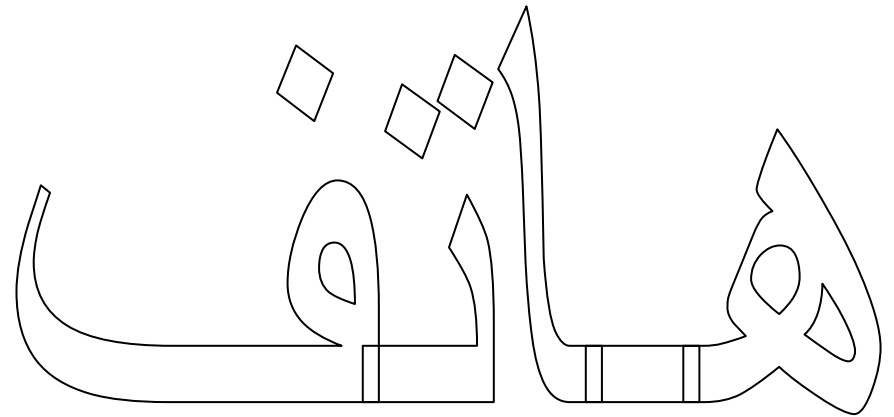
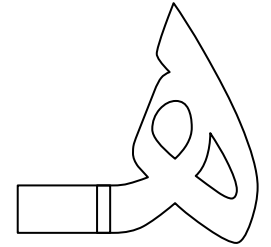
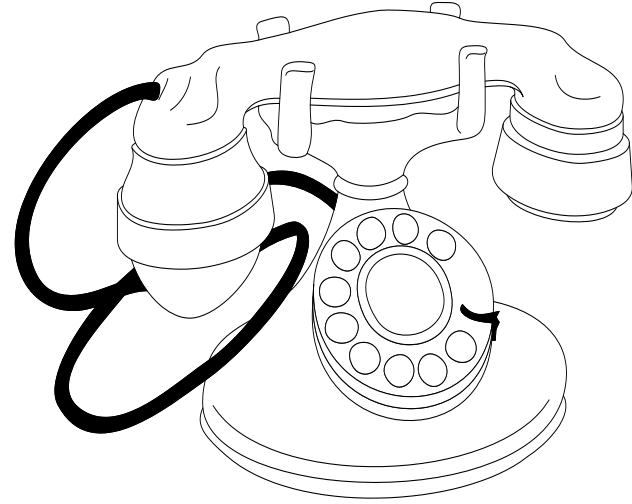

ه

ه

هاتف

لون

حرف الواو

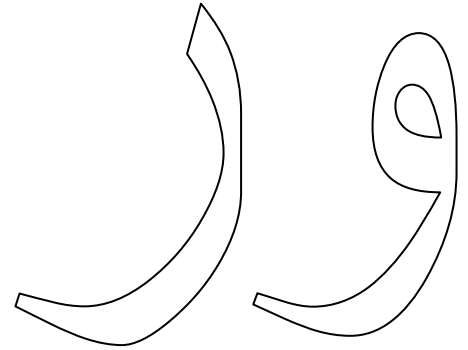
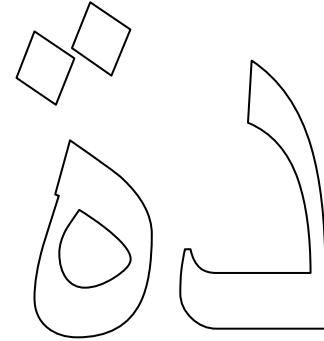
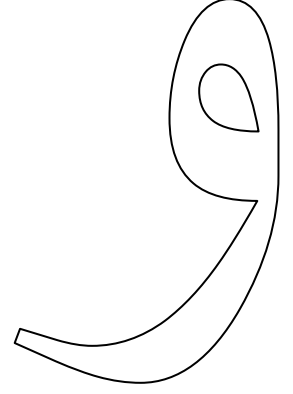
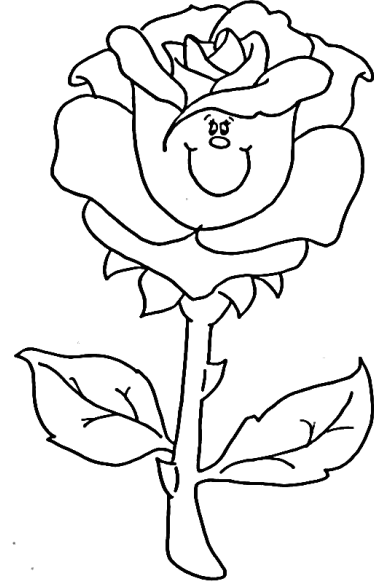

و

و

وردة

نون

حرف الياء

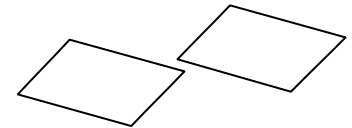
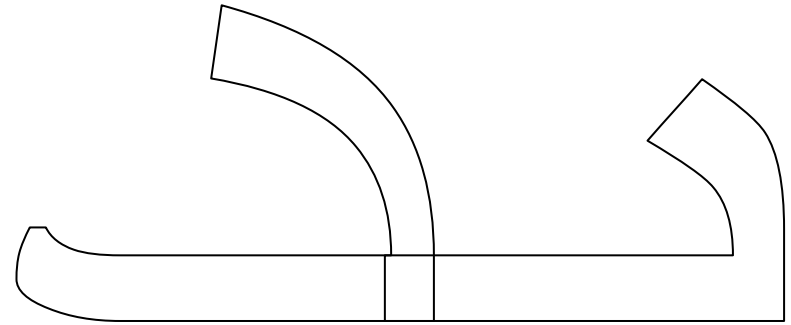
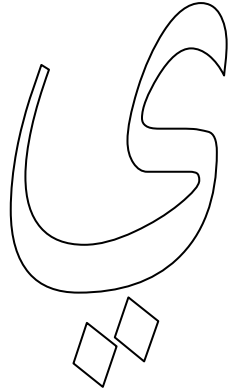

ي

يا

يا

مع تحيات توجية رياض
الأطفال بولاق الذكرور
موجهه رياض الأطفال :-
حسنه سعد مرسي