



**P**repared **B**y:

Mr **R**agab **A**hmed

Aa



A A A A A A A

a a a a a a a a a a a

Aa Aa Aa Aa Aa

Aa

apple apple apple apple

apple

# Aa



## 1-Colour and say:

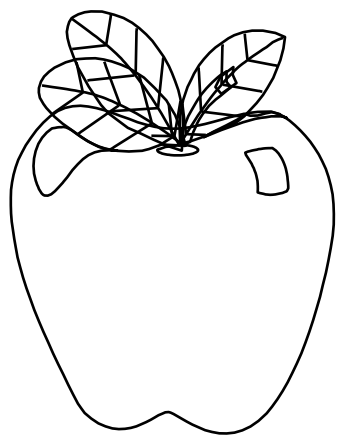

Apple

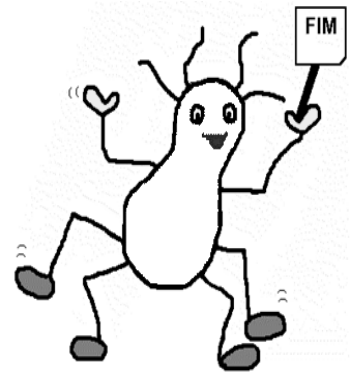

Ant

### FUN ZONE

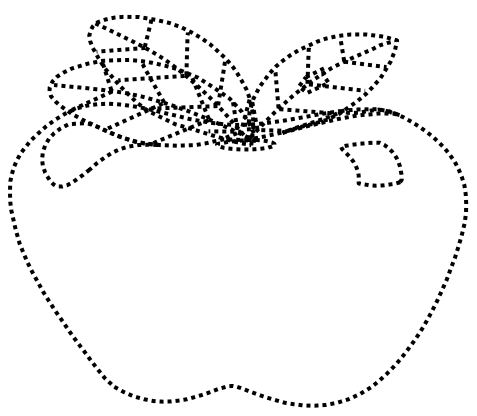

Apple

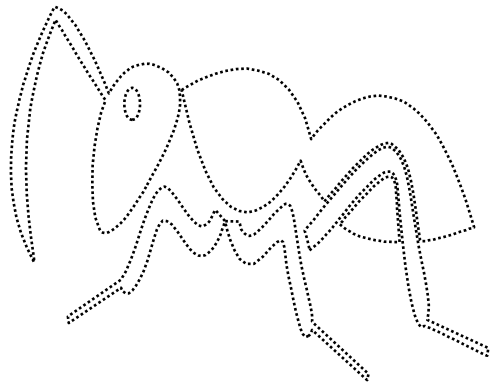

Ant

# Aa



Bb

B B B B B B B B

b b b b b b b b b b

Bb Bb Bb Bb Bb Bb

Bb

ball ball ball ball

ball

# Bb



## 2-Colour and say:

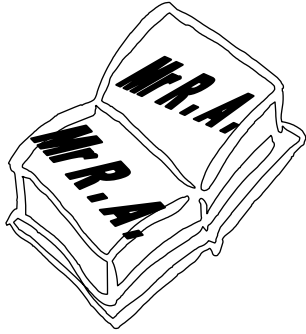

book

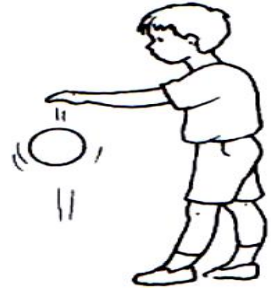
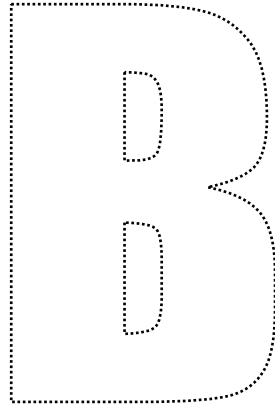

boy

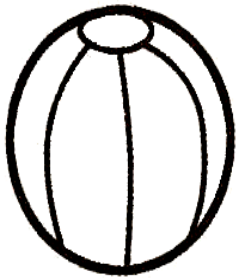

ball

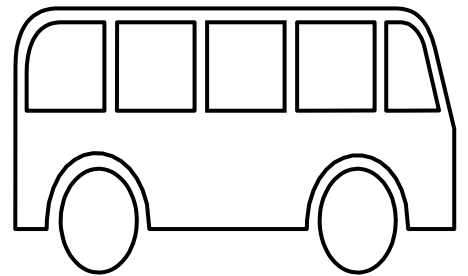
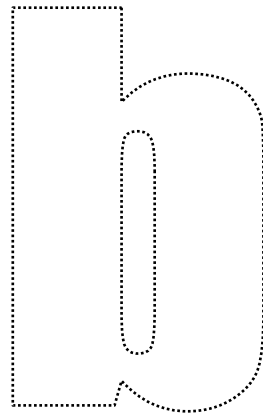

bus

### FUN ZONE

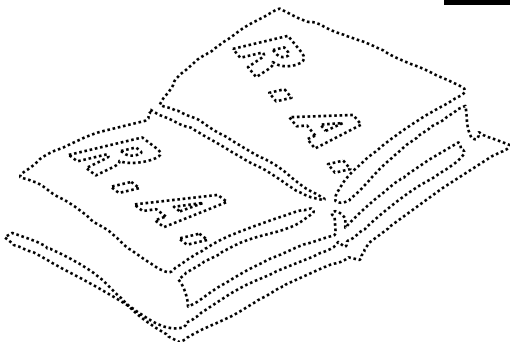

book

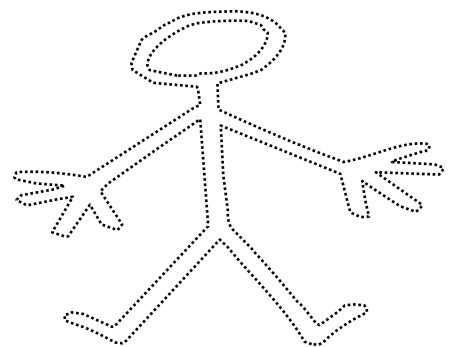

body

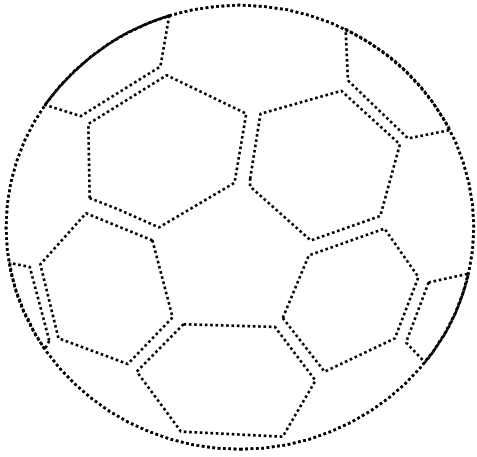

ball

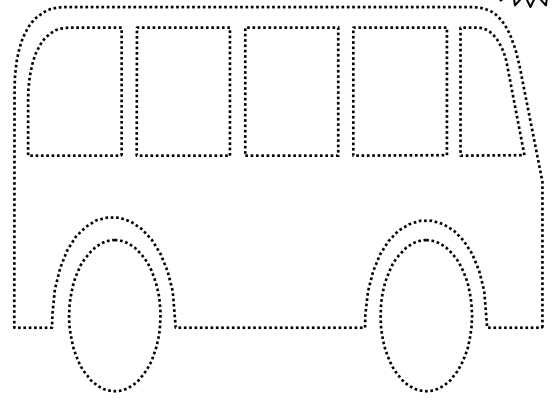

bus

**1-Match the words with the pictures:**

- 1- ball
- 2- apple
- 3- ant
- 4- book

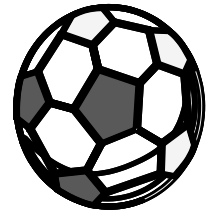
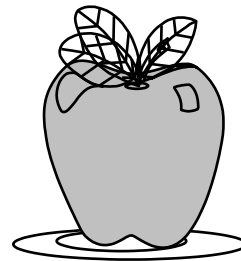
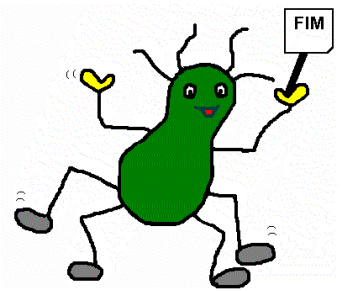

**2-Write the first letter under each picture :**

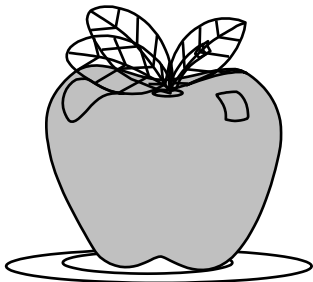

.....



.....

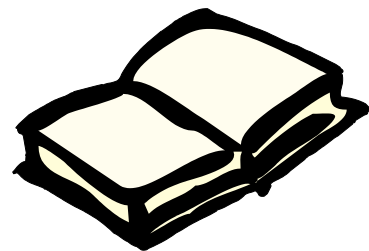

.....

Cc



C C C C C C C C

c c c c c c c c c c c c

Cc Cc Cc Cc Cc

Cc

cat cat cat cat cat

cat

# Cc



## 3-Colour and say:

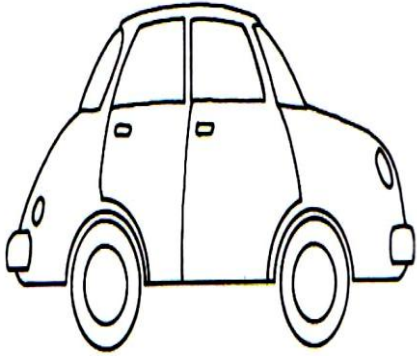

car

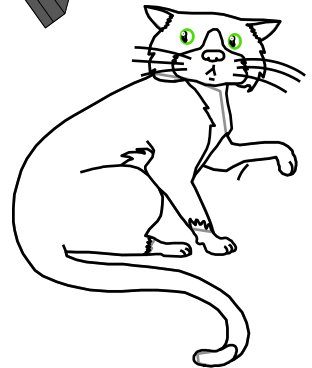
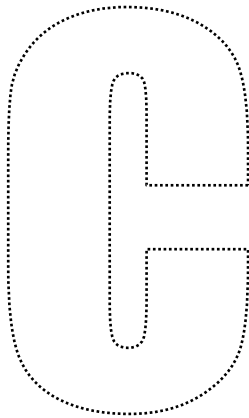

cat

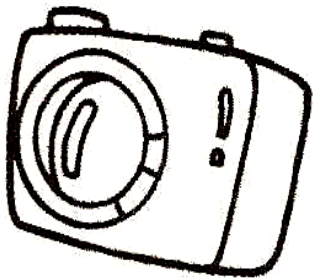

camera

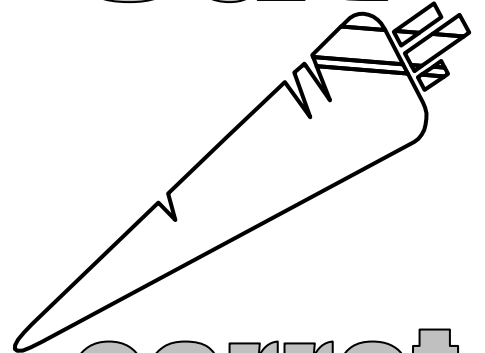
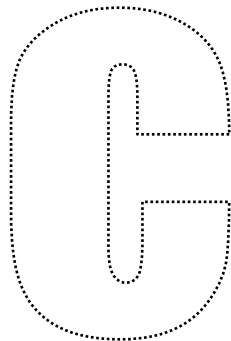

carrot

### FUN ZONE

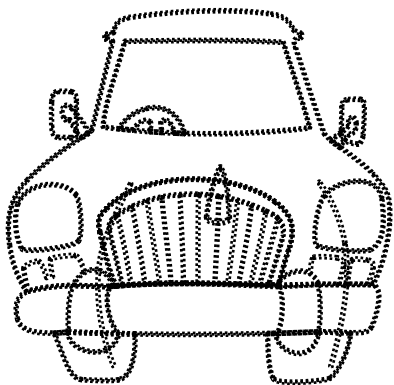

car

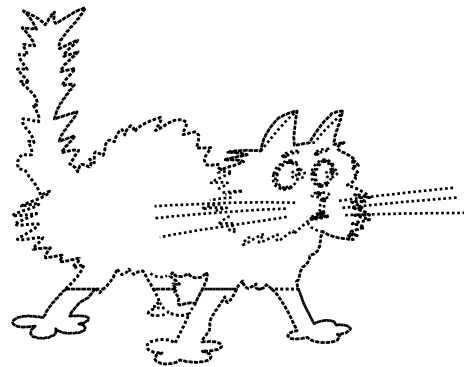

cat



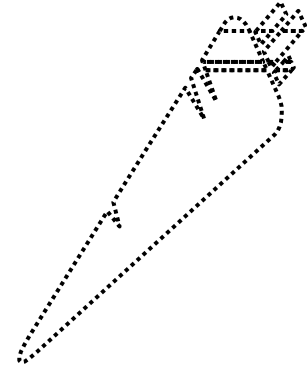
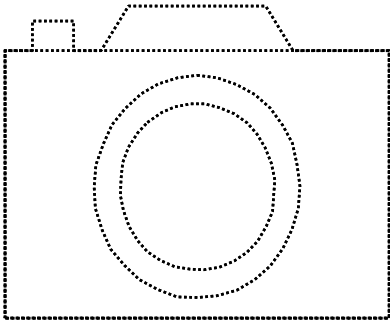

camera

carrot

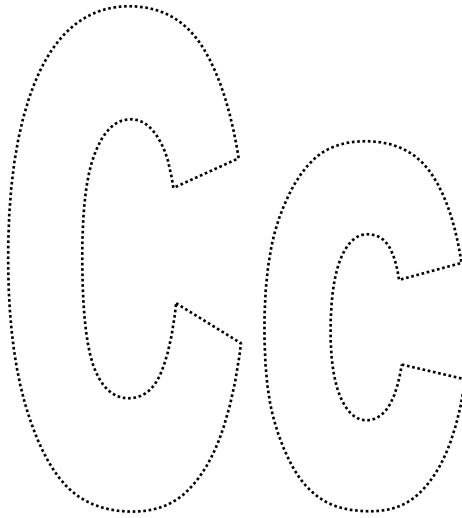

1-Match the words with the pictures:

1- car

2- cat

3- camera

4- boy

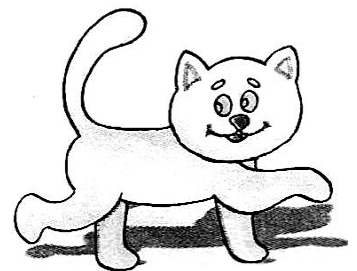
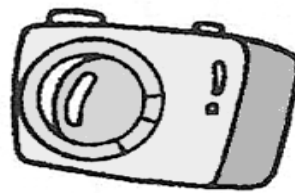

Dd



D D D D D D D

d d d d d d d d d d

Dd Dd Dd Dd Dd Dd

Dd

duck duck duck duck

duck

Dd



4-Colour and say:

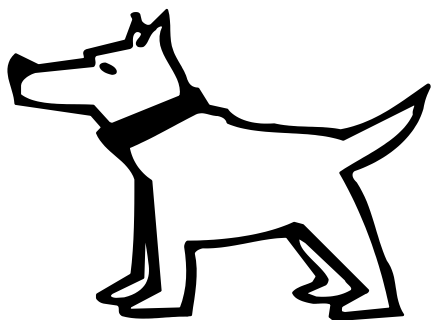

dog

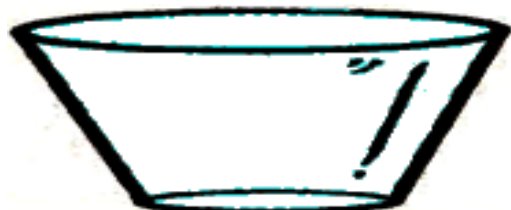
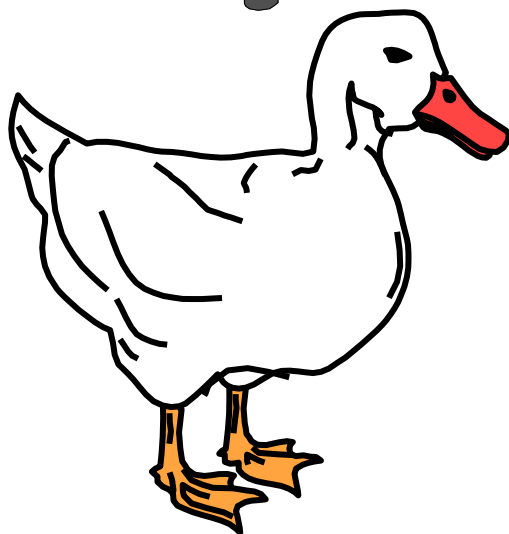
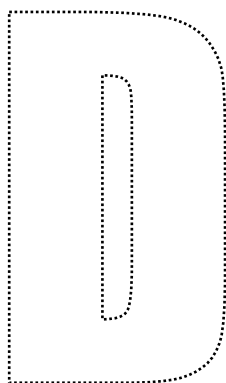

dish

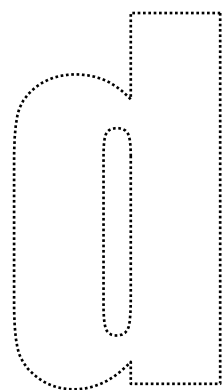

duck

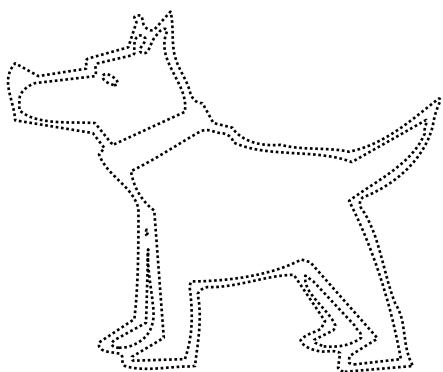
**FUN ZONE**

dog

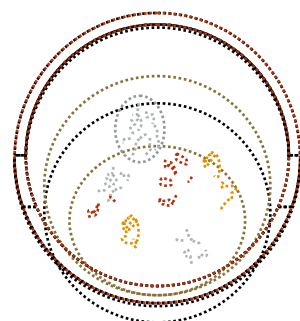

dish

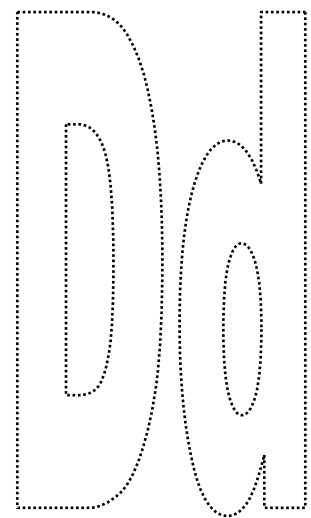
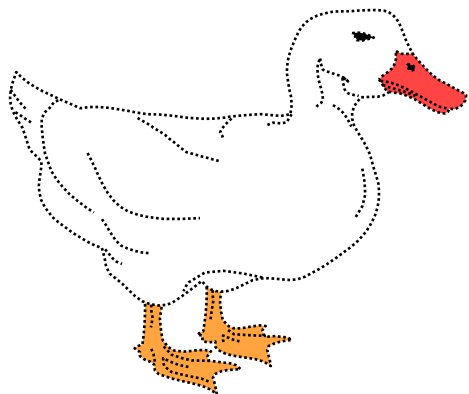

duck

**1 -Write the first letter under each picture :**

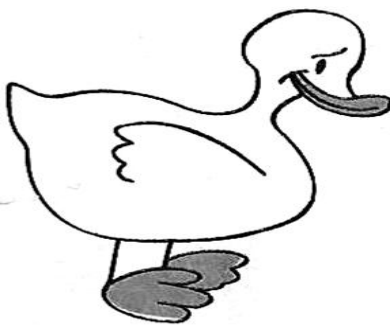
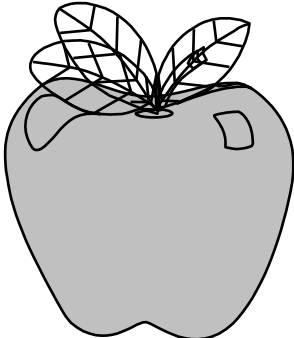

.....

.....

.....

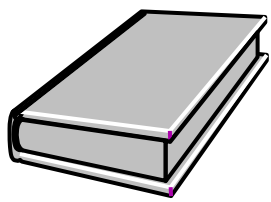

.....

.....

.....

**2-Write the capital letters for the following small letters :**

a

b

c

d

.....

.....

.....

.....

Ee

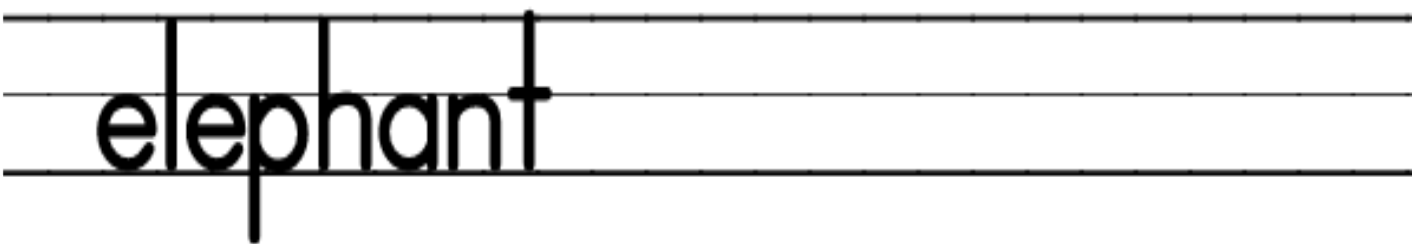
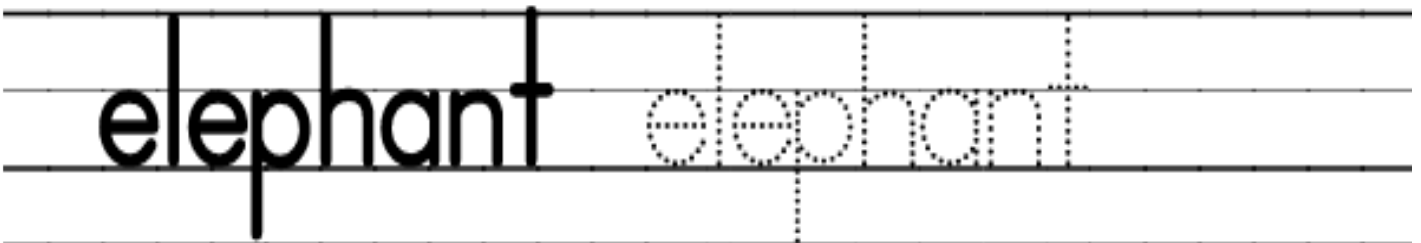
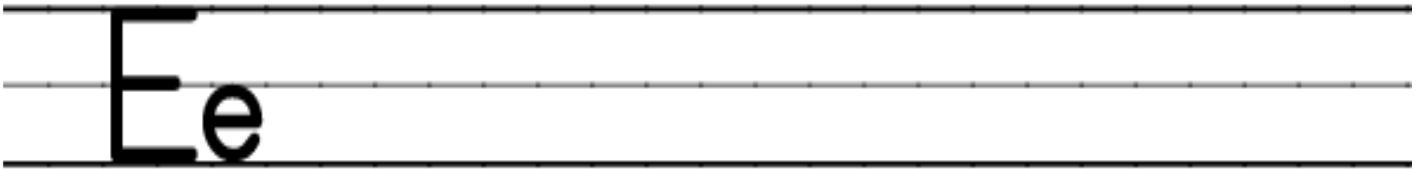
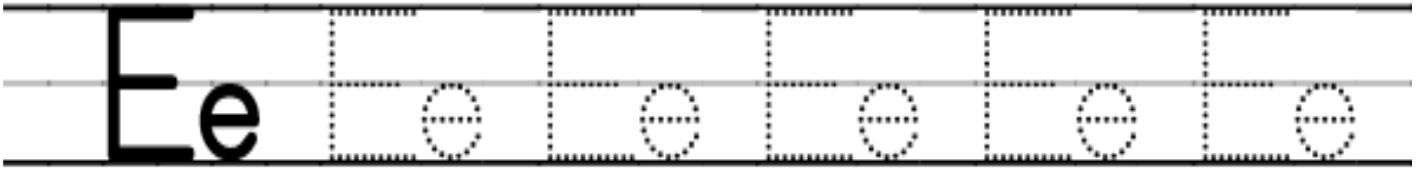
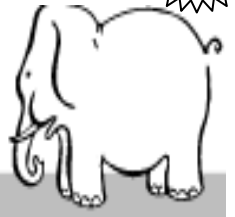

Ee



4-Colour and say:

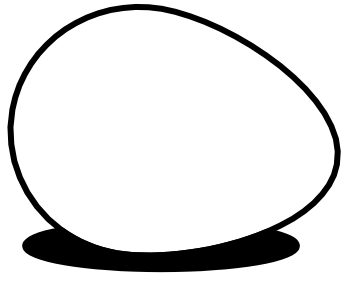

egg

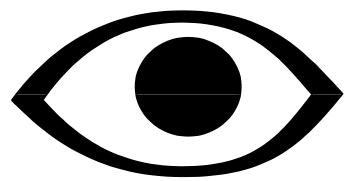
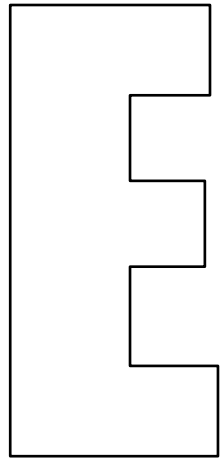

eye

8

eight

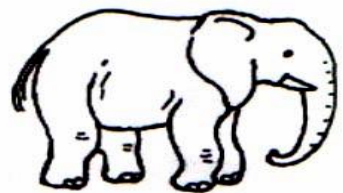
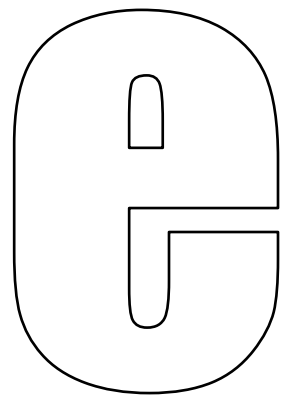

elephant

**FUN ZONE**

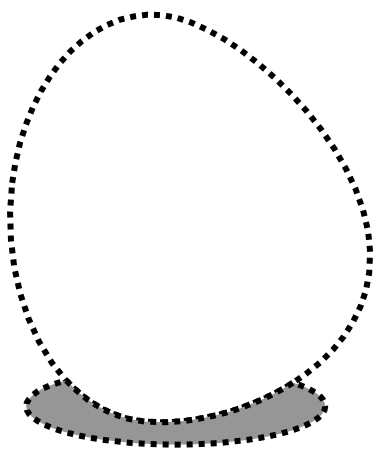

egg

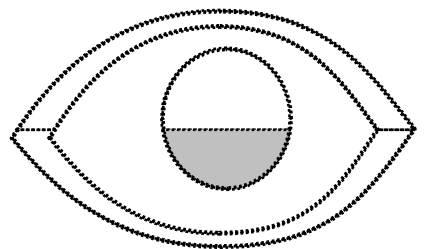

eye

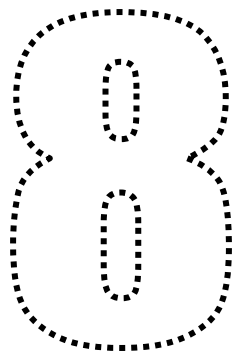

eight

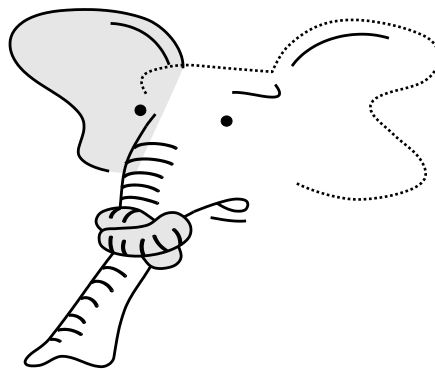

elephant

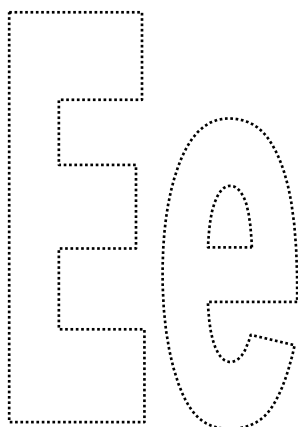

**1 -Write the small letters for the following capital letters :**

**A**

**B**

**C**

**D**

**E**

**2- Circle the different picture:**

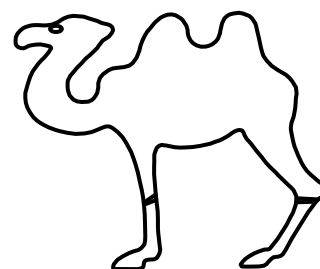



Ff

F F F F F F F F F F

f f f f f f f f f f

Ff Ff Ff Ff Ff Ff Ff Ff

Ff Ff Ff Ff Ff Ff Ff Ff

fish fish fish fish fish fish fish fish

fish fish fish fish fish fish fish fish



Ff



6-Colour and say:

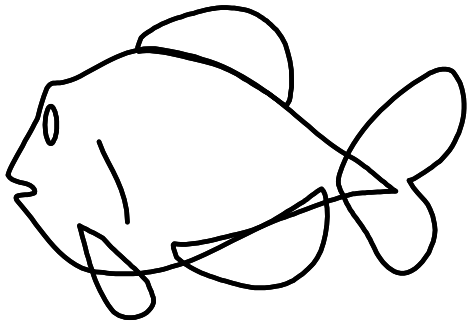

fish

F

f

5

five

**FUN ZONE**

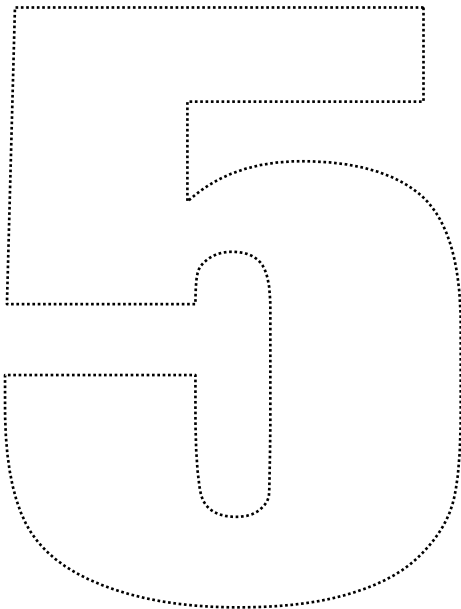

five

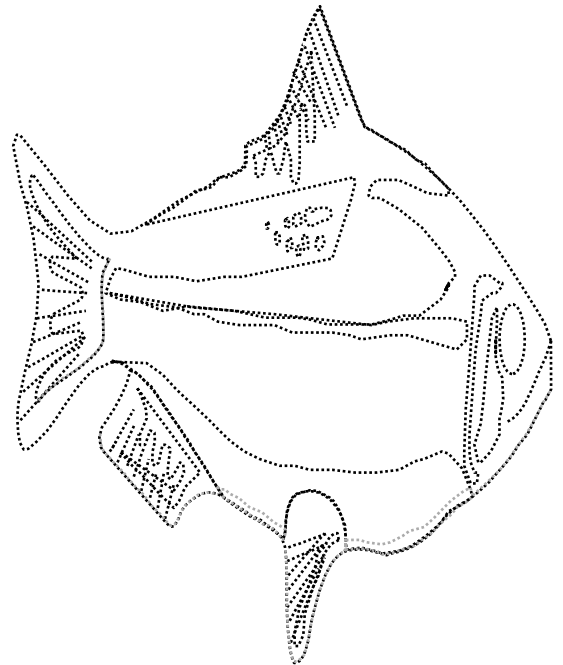

fish

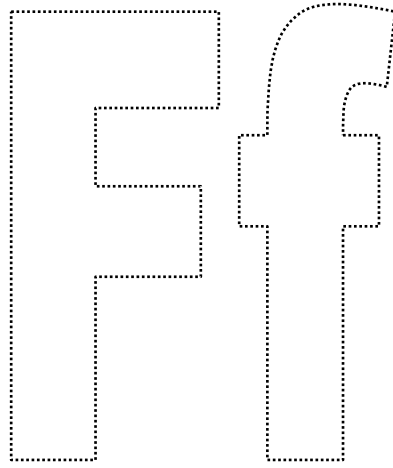

**1- Complete the following letters :**

**Aa**

**...b**

**Cc**

**D....**

**E....**

**...f**

**2- Listen and circle the right picture :**

1.

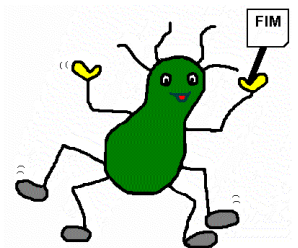
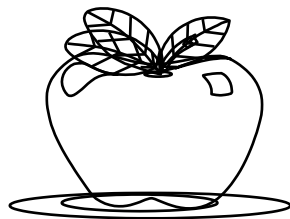

2.

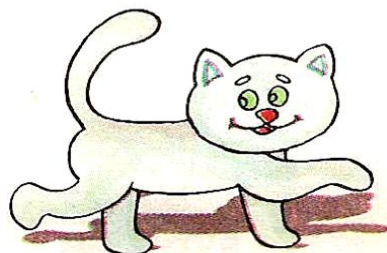

Gg

Gg



G G G G G G G

g g g g g g g g g g

Gg Gg Gg Gg

Gg

grapes grapes grapes

grapes

# Gg



## 7-Colour and say:

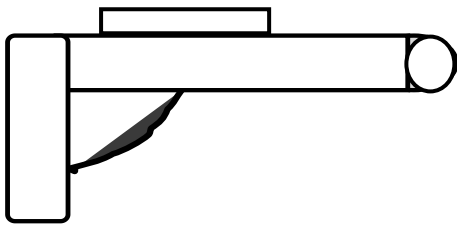

gun

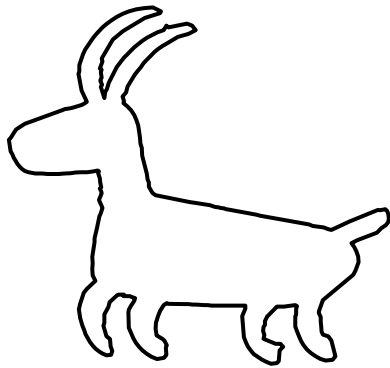

goat



Goodbye.

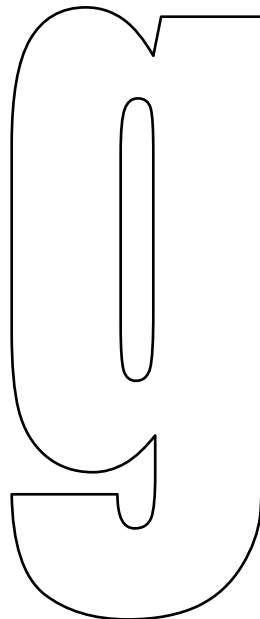
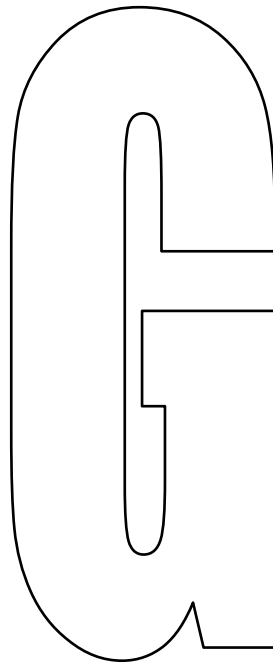

girl

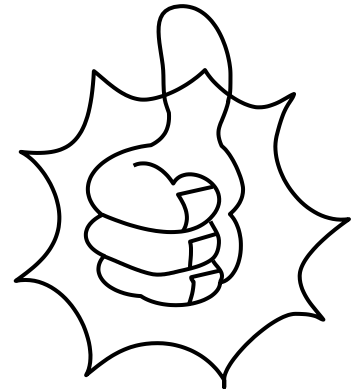

Good.

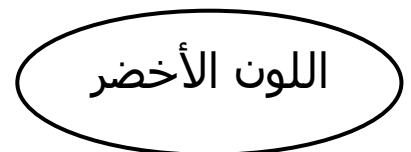

green

# Fun Zone

## 1-Match and colour :

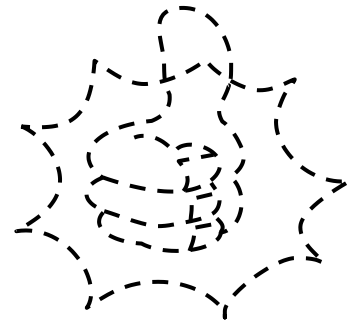
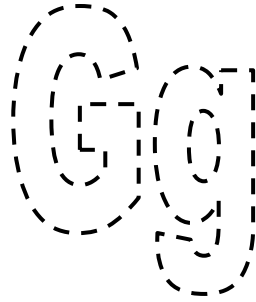
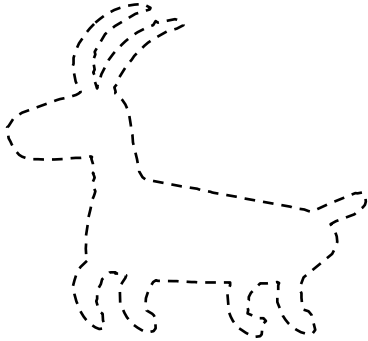

## 2-Match the words with the pictures:

1- Goodbye

2- G

3- good

4- gun

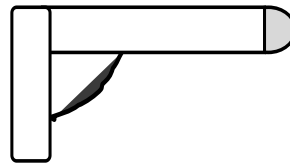
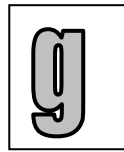

## 3-Write the first letter under each picture:

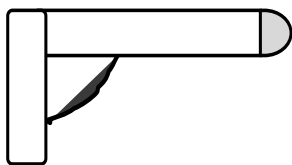

.....



.....



.....

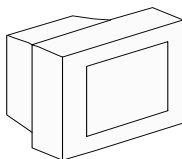

.....



.....



.....



# Hh



## 8-Colour and say:

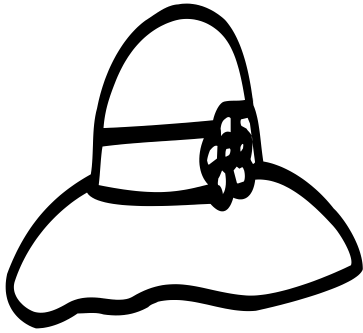

hat

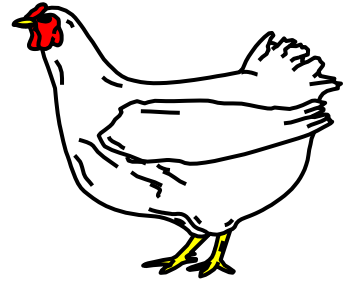
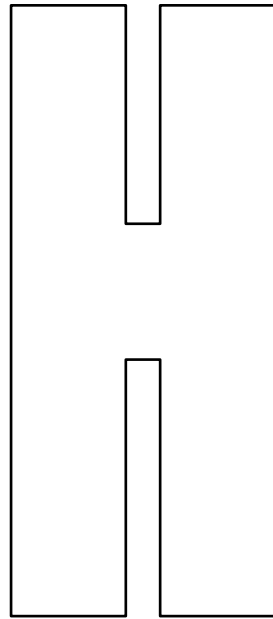

hen



hand

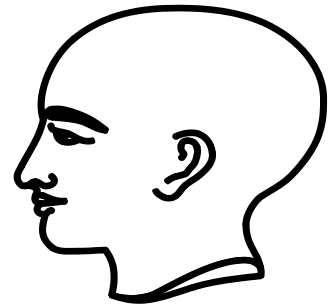

head

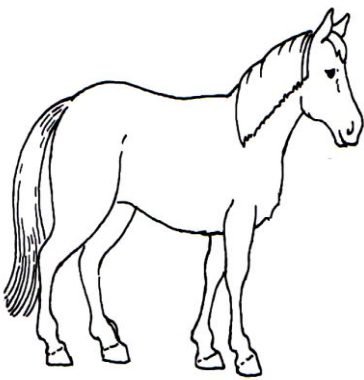

horse

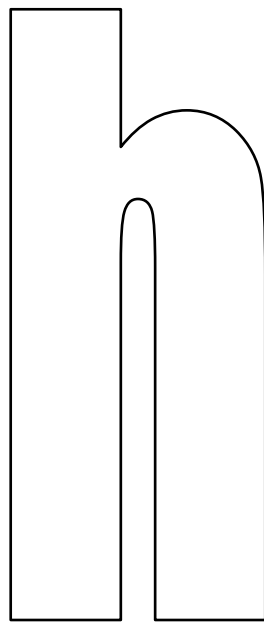







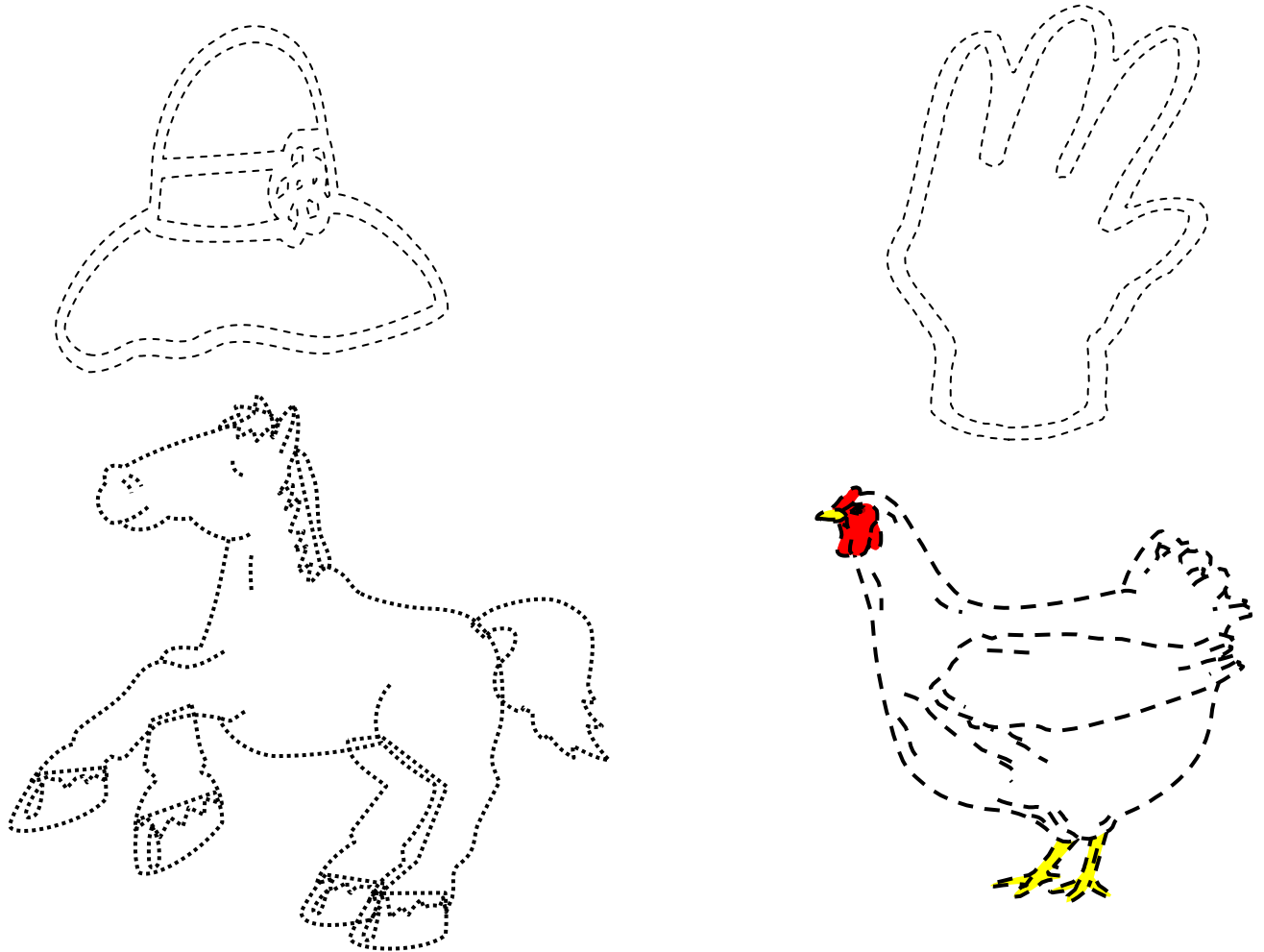

house

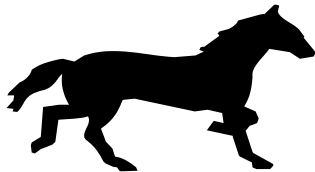
# Fun Zone

## 1-Match and colour :

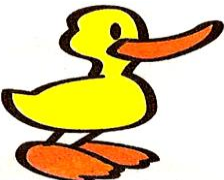

## 2- Circle the different picture:

1-			
2-			
3-			





Ii



9-Colour and say:

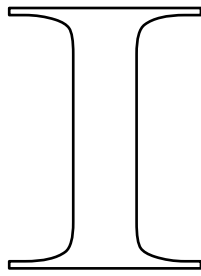

ice-cream

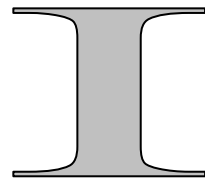
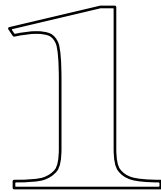
1-Supply the missing letters :

1- ice crea.....

2- appl.....

3- c..t

4- bo.....

5- han.....

6- hors...

2-Match the words with the pictures :

1- car

2- ball

3- I

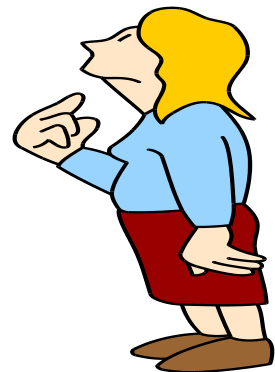
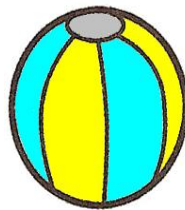



Jj



10-Colour and say:

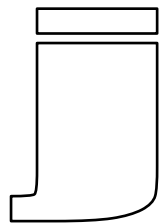
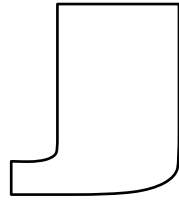

jacket

jump

1-Match the words with the pictures :

1-jump

2-egg

3-hen

4-duck

5- one

6-two

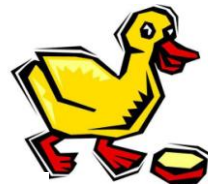
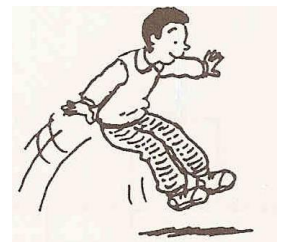

1

2

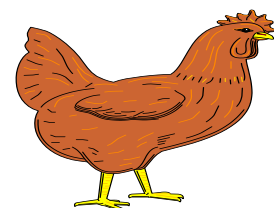

Kk



Kk

K K K K K K K K

k k k k k k k k

Kk Kk Kk Kk Kk Kk

Kk

kite kite kite kite

kite

# Kk



## 11-Colour and say:

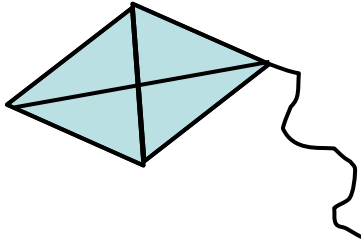

# K

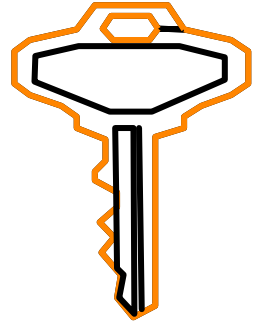

# kite

# k

# key

### Fun Zone

1-Match and colour :

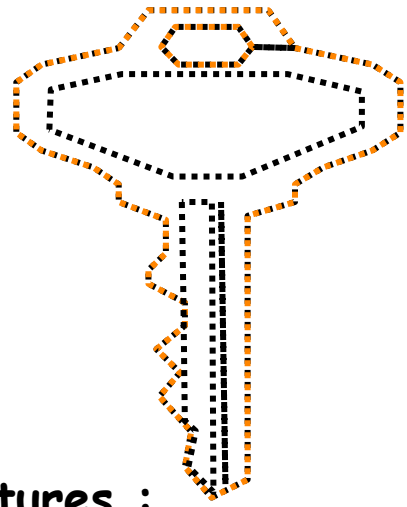
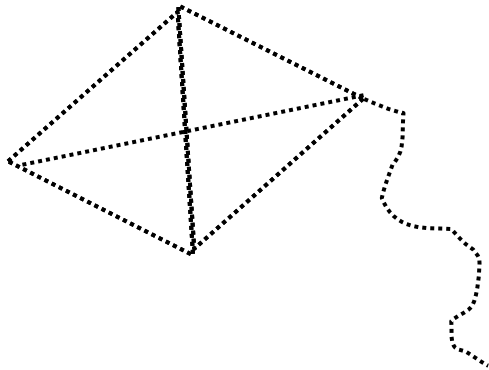

2-Match the words with the pictures :

1-key

2-kite

3-elephant

4-hat

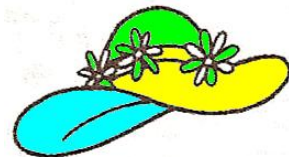
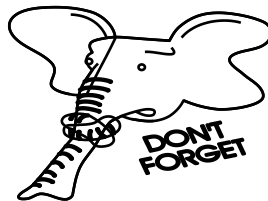
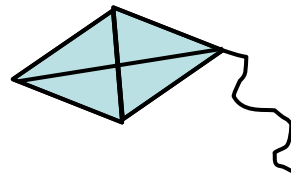



LI  
12-Colour and say:



lion

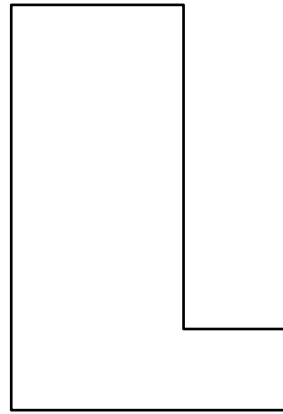

lollipop

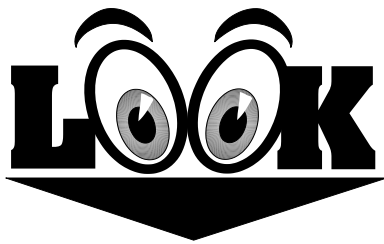

LOOK.

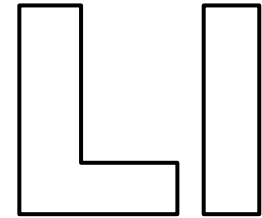

1-Match the words with the pictures :

1- look

2- lion

3- lollipop

4- kite

5-jacket

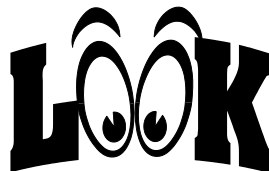
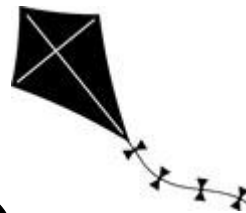
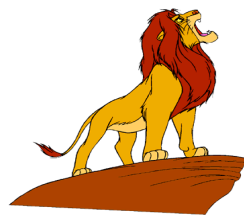



Mm



Mm

M M M M M M M M M M

m m m m m m m m m m

Mm Mm Mm Mm

Mm

mouse mouse mouse

mouse

Mm



13-Colour and say:



monkey

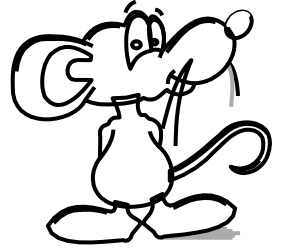
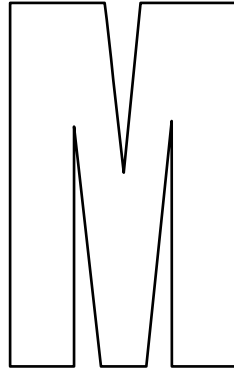

mouse



mother

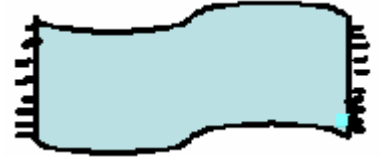
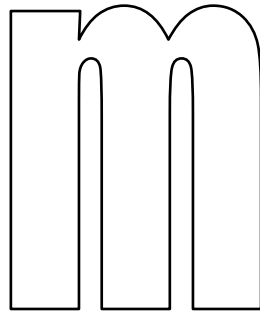

mat

Fun Zone

1-Match and colour :

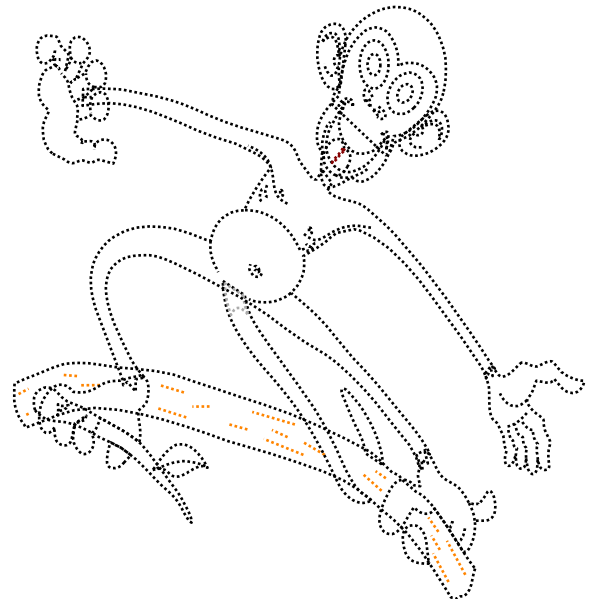
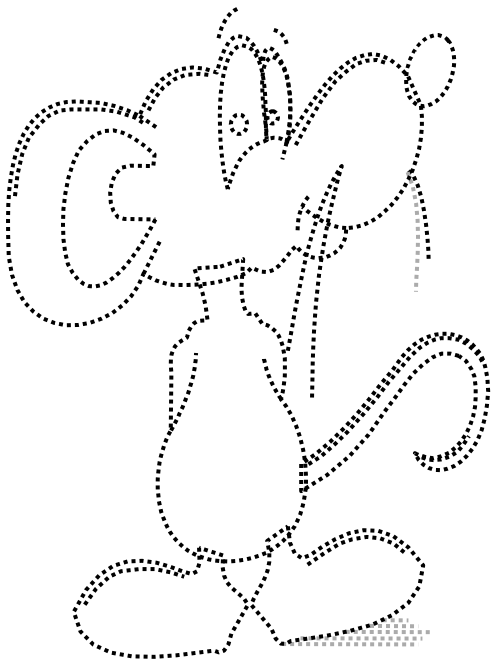

**2-Match the words with the pictures:**

1-man

2-mother

3-mat

4-moon

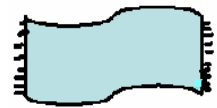

**3- Write the words under each picture:**

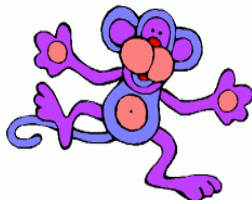

.....



.....



.....

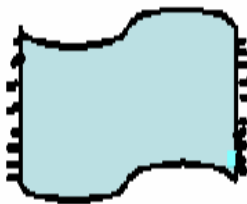

.....

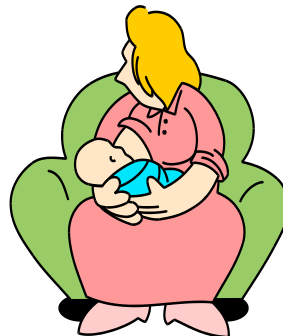

.....

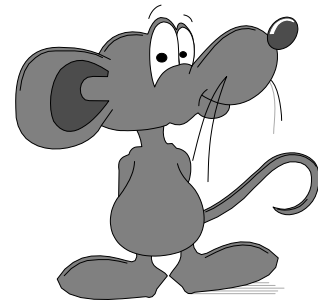

.....

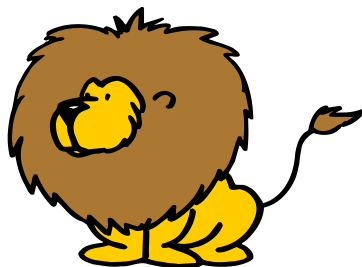

.....

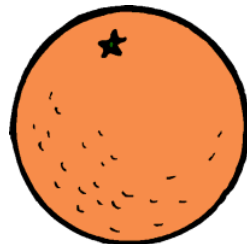

.....

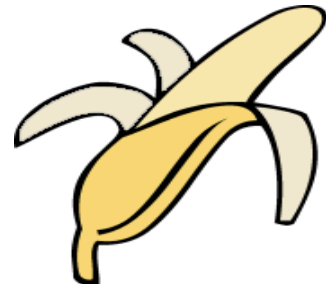

.....

Nn

Nn



N N N N N N N N N N N N N N N N

n n n n n n n n n n n n n n n n

Nn Nn Nn Nn Nn Nn

Nn

nest nest nest nest

nest

# Nn

## 14-Colour and say:



9  
nine

N



No

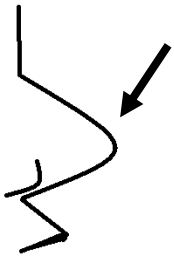

nose

n

Nn

1-Match the words with the pictures :

1-nose

2-No

3- nine

4-fish

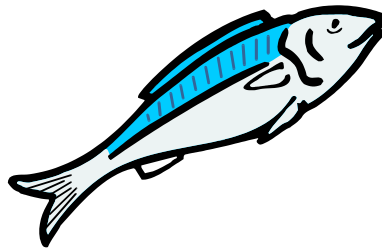

9

Oo



Oo

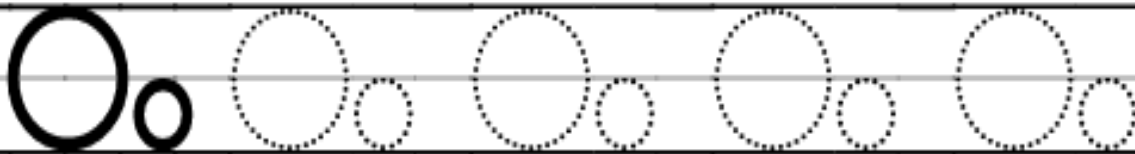
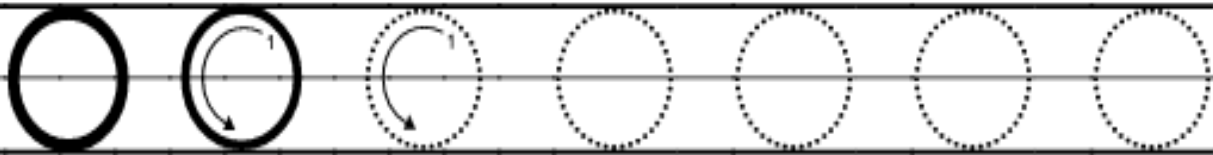

Oo

octopus octopus

octopus

Oo



# 15-Colour and say:

1

O

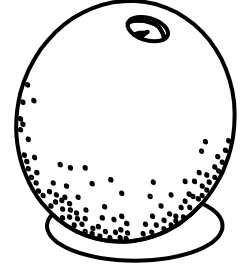

one

O

orange

## Fun Zone

1-Match and colour :

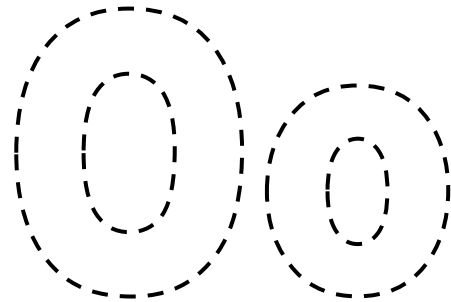
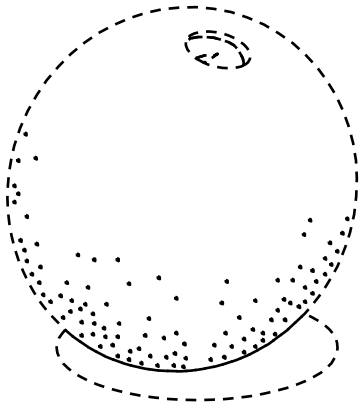

2-Match the words with the pictures :

1-five

2-one

3-orange

4-hen

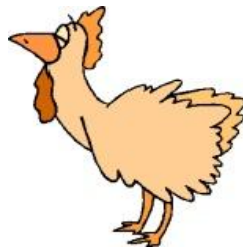

5

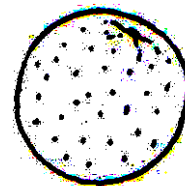

Pp



Pp

P P P P P P P P

p p p p p p p p p p

Pp Pp Pp Pp Pp Pp Pp

Pp

parrot parrot parrot

parrot



# Pp



## 16-Colour and say:

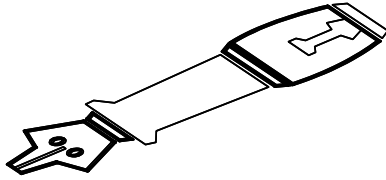

pen

# P



pencil

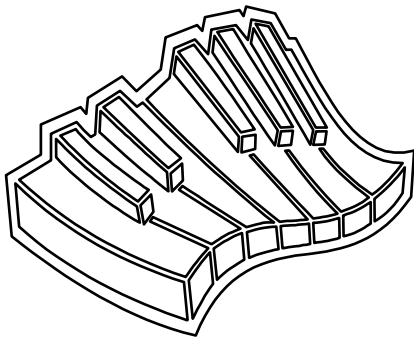

piano

# p



play

## Fun Zone

1-Match and colour :

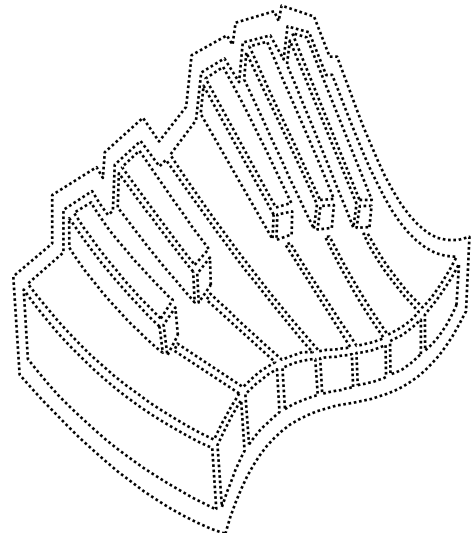
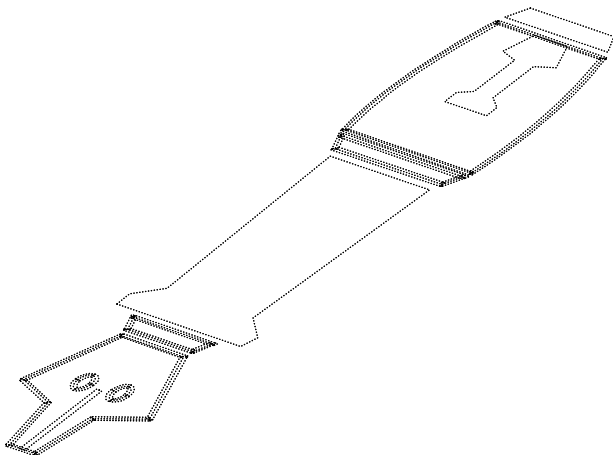

**2-Match the words with the pictures :**

1-pen

2-pencil

3-play

4-plane

5- piano

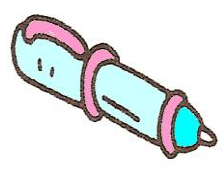
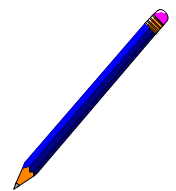
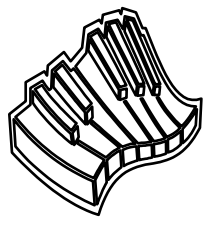

**3- LISTEN AND CIRCLE THE CORRECT PICTURE**

1.



2.

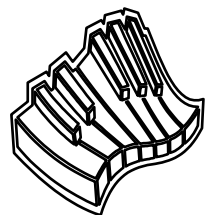
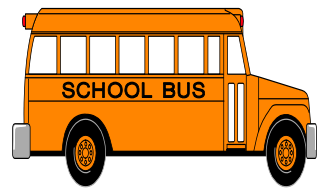
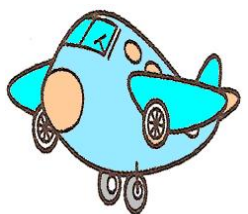

3.

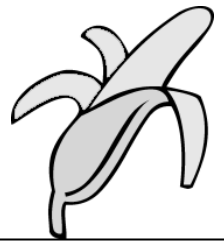
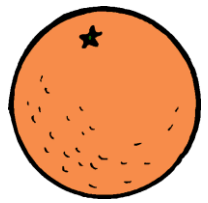
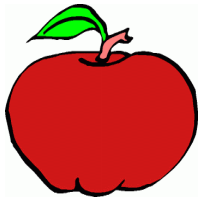

4.

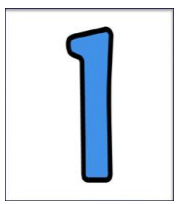

Qq



Qq

Q Q Q Q Q Q Q

q q q q q q q q q

Qq Qq Qq Qq Qq

Qq

quilt quilt quilt quilt

quilt

# Qq



## 17-Colour and say:

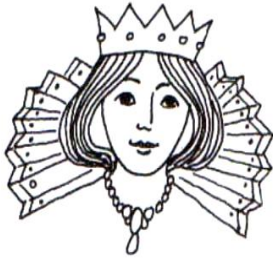

queen

# Qq

### 1-Rearrange the following letters to make meaningful words:

1- pne

2- pencli

3- plya

.....

.....

.....

5- piaon

7- kiet

6- cta

.....

.....

.....

### 2-Match the words with the pictures :

1-queen

2-kite

3- banana

4-book

5-bee

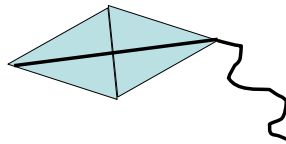



# Rr



## 18-Colour and say:

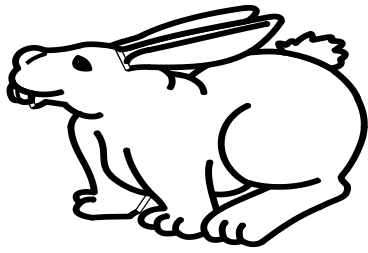

rabbit



rat

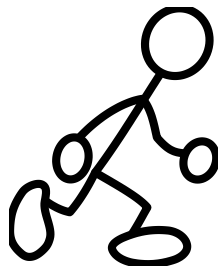

run

# Rr

1-Write the first letter:



2-Match the words with the pictures :

1-rabbit

2-rat

3-run

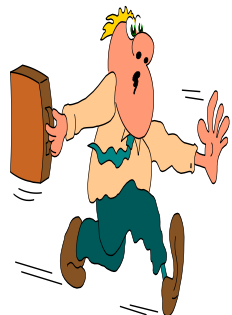

Ss

Ss



S S S S S S S S S

s s s s s s s s s s

Ss Ss Ss Ss Ss Ss

Ss

star star star star

star

# Ss



## 19-Colour and say:

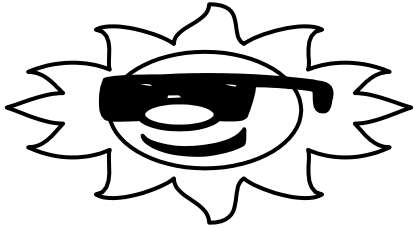

sun



star

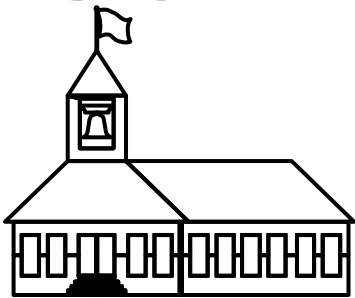

school

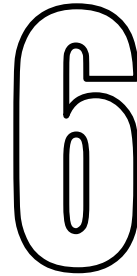
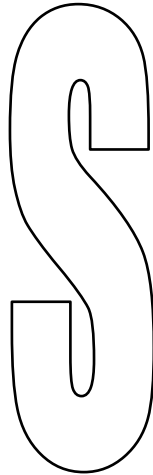

six

seven

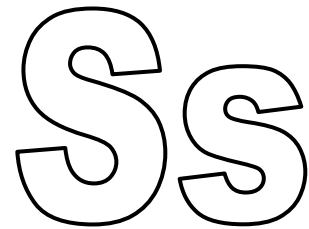
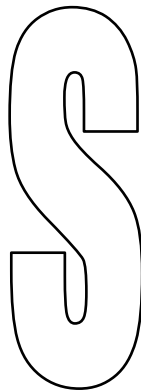

### Fun Zone

1-Match and colour:

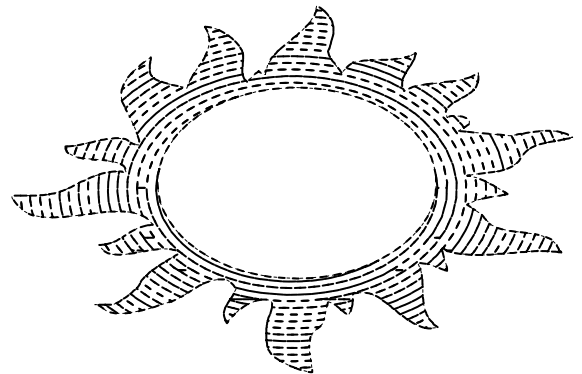
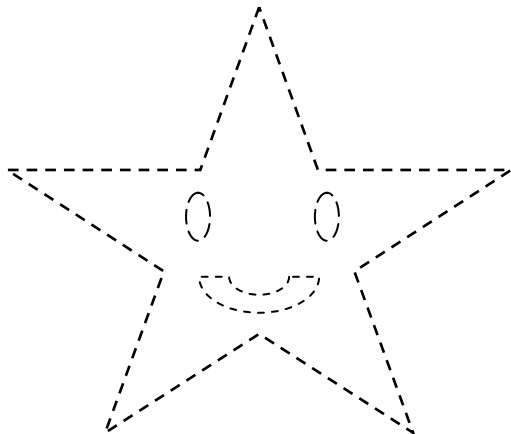



**2-Listen and do :**

- 1- Stand up.
- 2- Sit down.
- 3- Open your book.
- 4- Close your book.
- 5- Spell your name.

**3-Draw , colour and say:**

one apple

two apples

three apples

one book

two books

three books

one boy

two boys

three boys

Tt



Tt

Tt Tt Tt Tt Tt Tt Tt Tt

Tt Tt Tt Tt Tt Tt Tt Tt

Tt Tt Tt Tt Tt Tt Tt Tt

Tt Tt Tt Tt Tt Tt Tt Tt

tiger tiger tiger tiger

tiger

# Tt

## 20-Colour and say:



### 2

two



tree

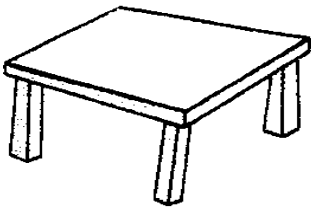

table

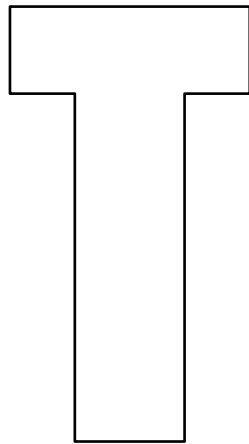

### 10

ten

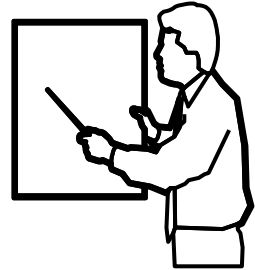

teacher

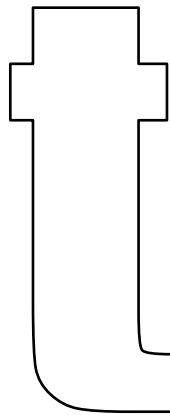

telephone

1-Match and say the numbers :

1- 4

2- 5

3- 6

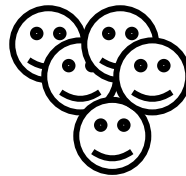
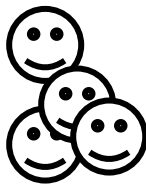

Uu



Uu

U U U U U U U U

u u u u u u u u

Uu Uu Uu Uu Uu Uu

Uu

umbrella umbrella

umbrella

# Uu

## 21-Colour and say:

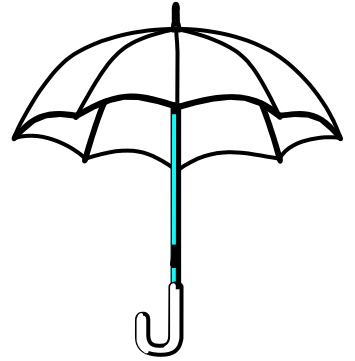
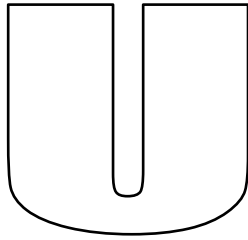

under

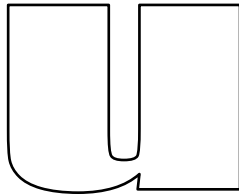

umbrella

### 1-Match the words with the pictures :

1- umbrella

2- book

3-tree

4-table

5-telephone

6-two

7-teacher

8-seven

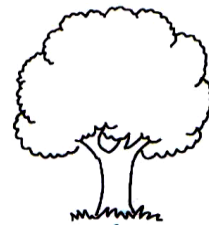
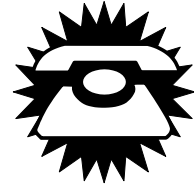
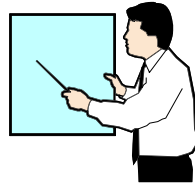

**2- Write the capital letters for the following small letters :**

a            b            c            d            e            f

.....

g            h            i            j            k            l

.....

m            n            o            p            q            r

.....

s            t            u

.....

**3- Look at the pictures. Read the words and circle (Yes) or (No):**

Yes



No

X

1- A tree.

Yes

No



2- A boy.

Yes

No



3- A book.

Yes

No

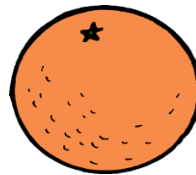

4- An egg .

Yes

No

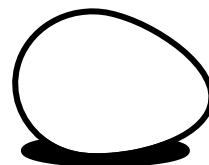

Vv

Vv



V V V V V V V V V V

v v v v v v v v v v

Vv Vv Vv Vv Vv Vv

Vv

vegetables vegetables

vegetables

Vv



# 22-Colour and say:

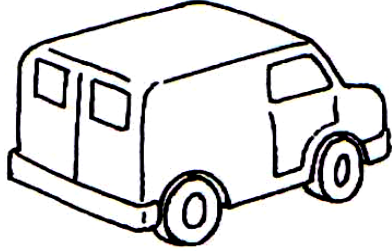

van

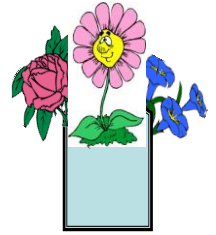
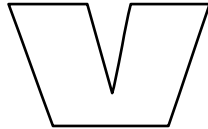
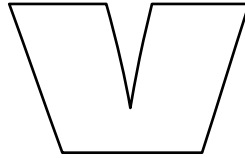

vase

## 1-Match the numbers :

- 1-one
- 2-two
- 3-three
- 4-five
- 5-four
- 6-six
- 7-seven

4

2

5

3

6

1

7

## 2- Look at the pictures and the letters , then write the words :

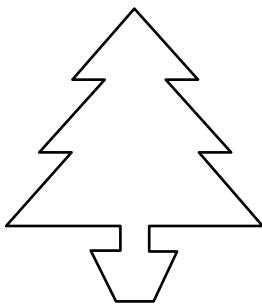

teer

.....

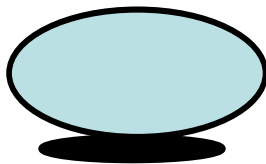

gge

.....



oby

.....

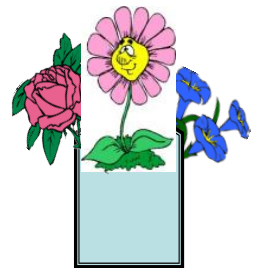

vaes

.....



Ww

Ww



W W W W W W W W W W W W

w w w w w w w w w w w w

Ww Ww Ww Ww Ww Ww Ww Ww

Ww

whale whale whale

whale

# Ww



## 23-Colour and say:

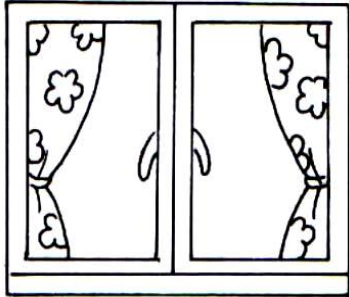

window

write

### Fun Zone

1-Match and colour:

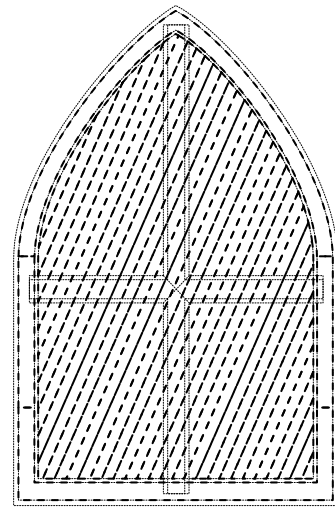

2-Match the words with the pictures :

1-window

2-write

3-van

4-vase

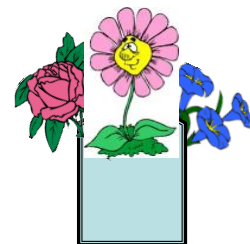
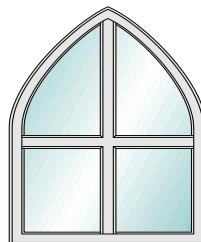



# Xx



## 24-Colour and say:

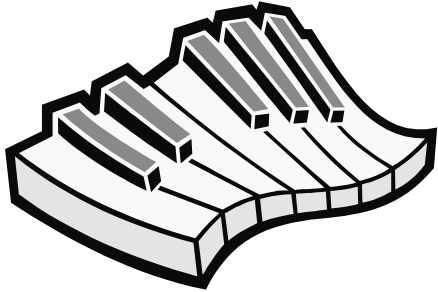

xylophone

# Xx

## Fun Zone

1-Match and colour:

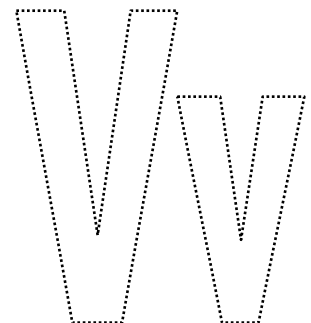
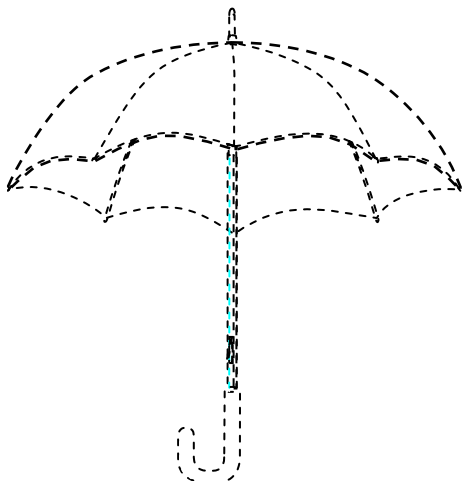
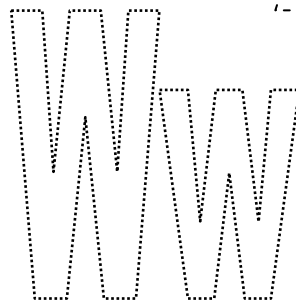
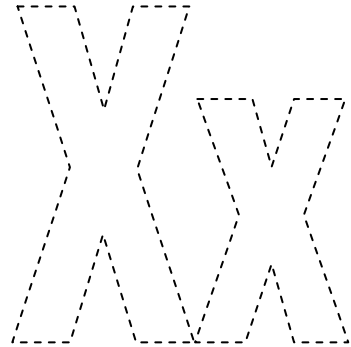
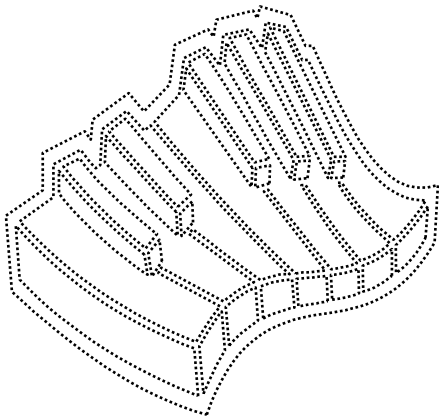

## 2-Match the words with the pictures :

1-six

2-ten

3-tree

4-xylophone

5-taxi

6-sun

7-star

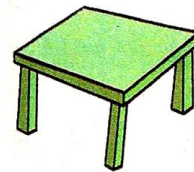
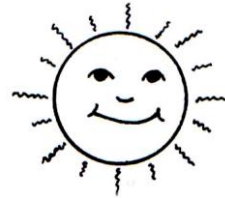
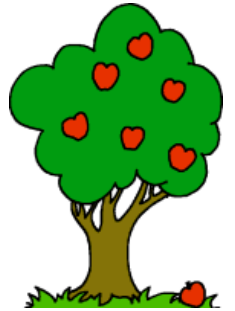
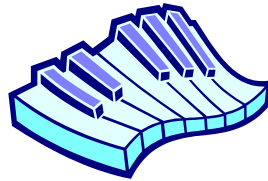

## 3- Listen to the words and circle the right picture :

1-

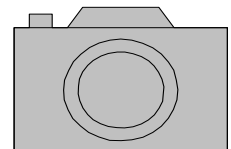
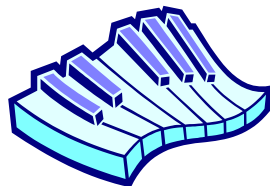

2-



3-

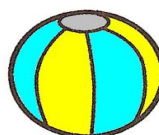

Yy



Yy

Yy Yy Yy Yy Yy Yy Yy

Yy Yy Yy Yy Yy Yy Yy Yy Yy Yy

Yy Yy Yy Yy Yy Yy Yy Yy

Yy

yarn yarn yarn yarn

yarn

Yy



# 25-Colour and say:



yoyo

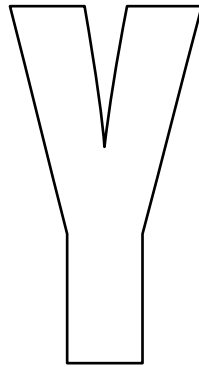

yellow



Yes

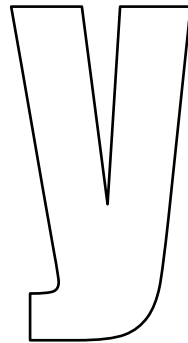

you

## 1-Match the words with the pictures :

1-yoyo

2-yes

3-boy

4-fish

5-you

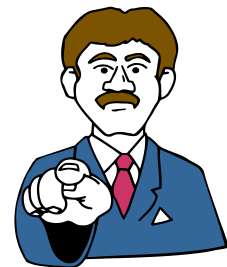
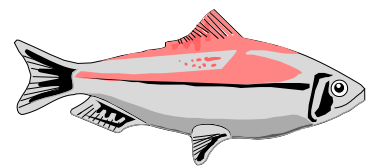

**YOU!**

Zz

Zz



Z Z Z Z Z Z Z Z Z Z

z z z z z z z z z z

Zz Zz Zz Zz Zz Zz Zz

Zz Zz Zz Zz Zz Zz Zz

zebra zebra zebra

zebra



# Zz

## 26-Colour and say:



zoo



zebra

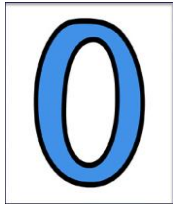

zero



### 1-Match the words with the pictures :

1-zoo

2-zero

3-zebra

4-rat

5-queen

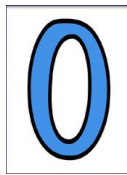

**2-Write the number under each box:**

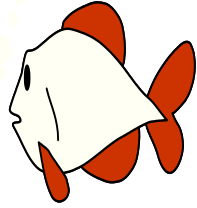



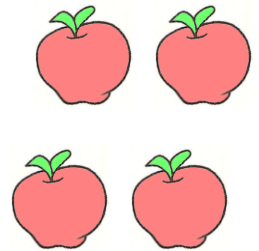

**3- Look at the pictures. Read the words and circle (Yes) or (No):**

Yes



No

X

1- A zoo.

Yes

No



2- A zebra.

Yes

No

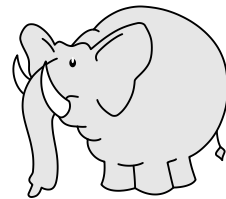

3- A hen.

Yes

No



4- A pen.

Yes

No

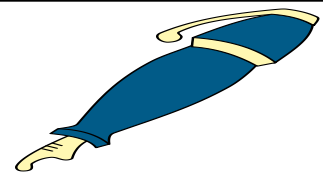

5- An arm.

Yes

No



# Mr Ragab's Mini-dictionary

apple

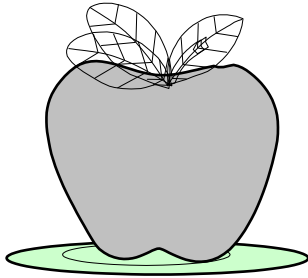

Aa

book

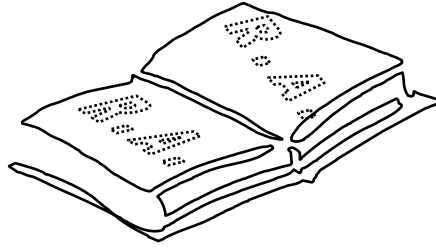

Bb

car



Cc

dog



Dd

egg

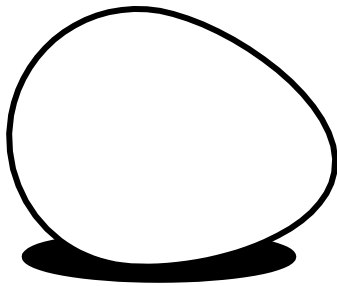

Ee

fish



Ff

girl



Gg

hat

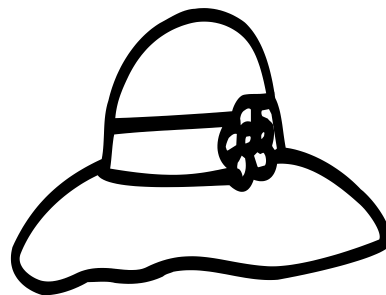

Hh

ice cream



Ii

jacket



Jj

kite

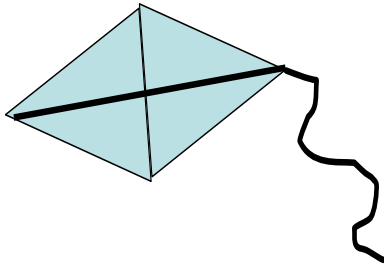

Kk

lion



Ll

mouse



Mm

nose



Nn

orange

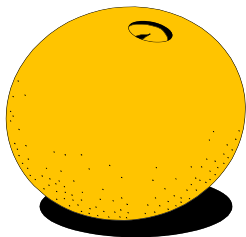

Oo

pencil

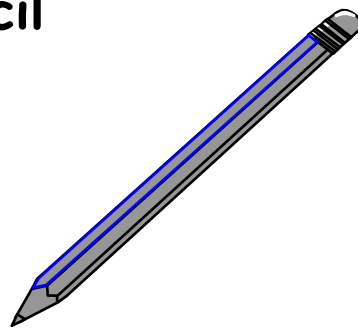

Pp

queen



Qq

rabbit

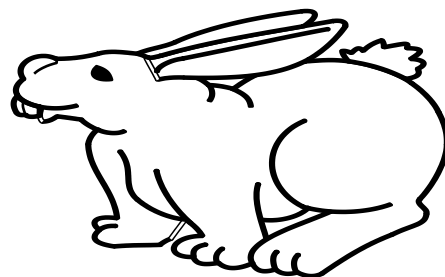

Rr

**sun**

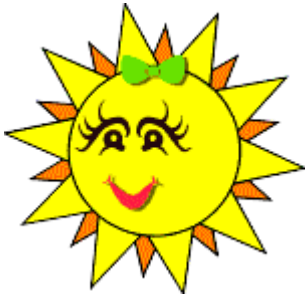

Ss

**tree**

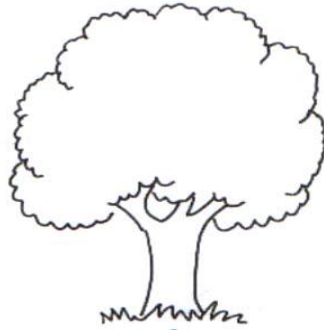

Tt

**umbrella**



Uu

**vase**



Vv

**window**

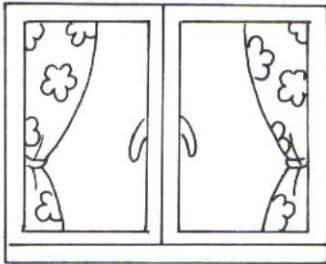

Ww

**x**

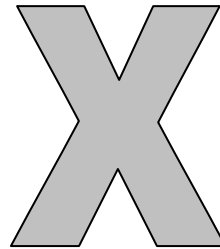

Xx

**yoyo**



Yy

**zoo**



Zz

# Mini-dictionary

Aa

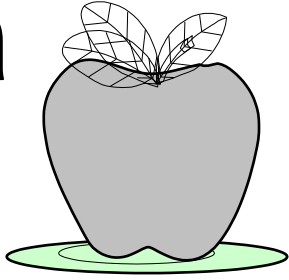

apple تفاحة



ant نملة

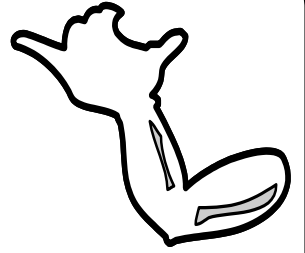

arm ذراع

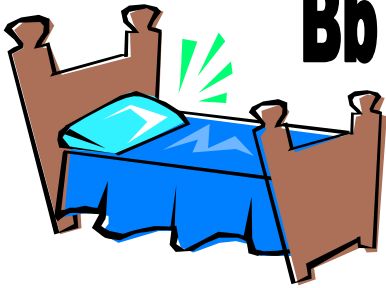

bed سرير



bag شنطة



bedroom حجرة النوم

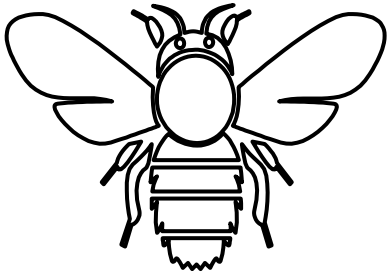

bee نحلة

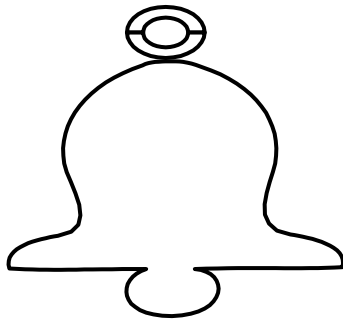

bell جرس



black اللون الأسود



blue اللون الأزرق

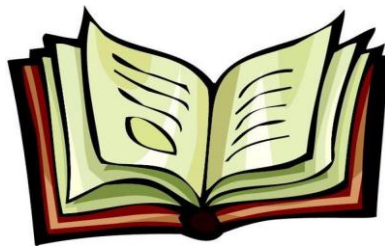

book كتاب



boy ولد

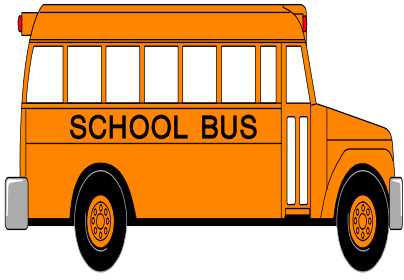

bus أتوبيس



ball كرة

Cc

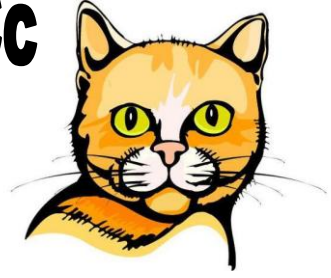

cat قطة



car سيارة

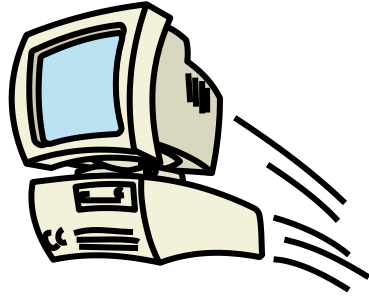

computer حاسب آلي

Dd

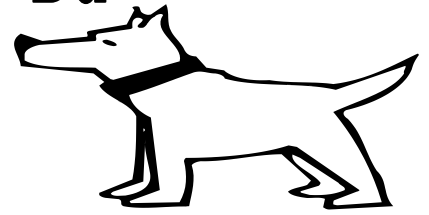

dog كلب



donkey حمار

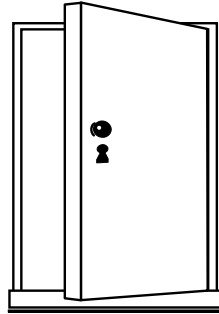

door باب

Ee

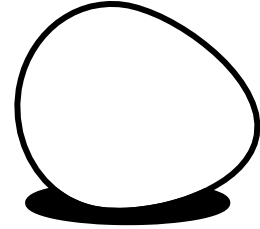

egg بيضة

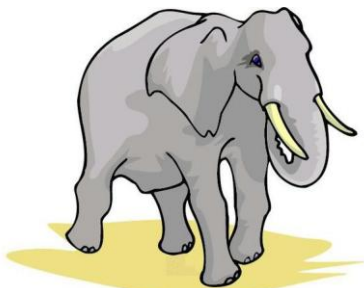

elephant فيل

Ff



father بابا



family عائلة ، أسرة

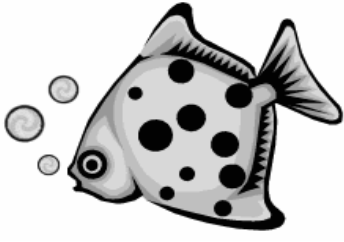

fish سمكة

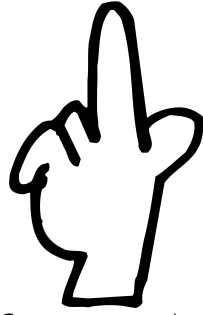

finger إصبع اليد



flag علم

Gg



girl بنت



goat معزة



اللون الأخضر green

Hh



hat برنيطة



house منزل



Ii

ice cream آيس كريم

Jj



jacket جاكيت



jump يقفز

Kk

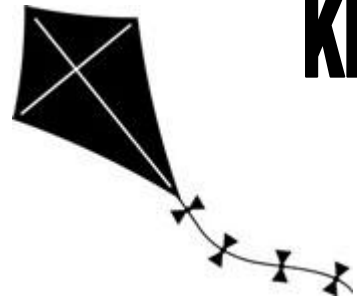

kite طائرة ورق



**Ll**

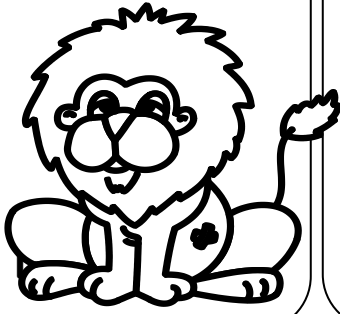

lollipop مصاصة

**Mm**

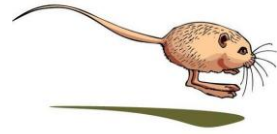

mouse فأر صغير



mother أم



mat سجادة

**Nn**

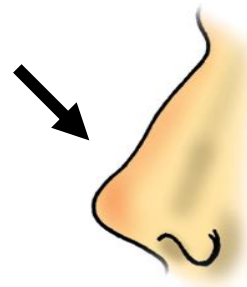

nose أنف

**9**

nine تسعة

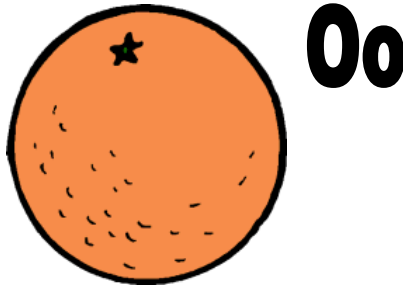

orange برتقالة

**1**

one واحد

**Pp**

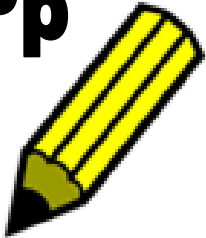

pencil قلم رصاص

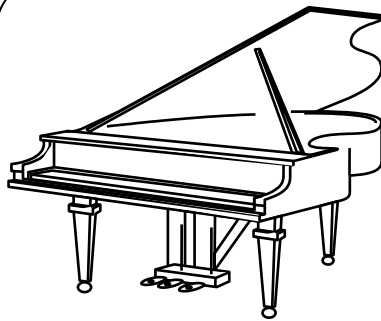

piano بيانو

**Qq**



queen ملكة

**Rr**

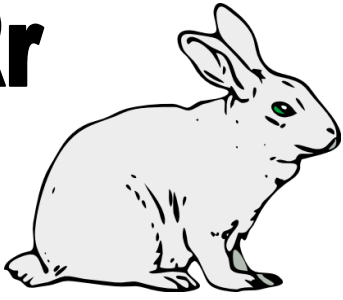

rabbit أرنب



run يجرى

**Ss**

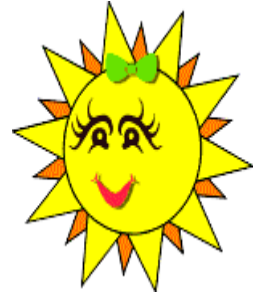

sun شمس

**6**

six ستة

**7**

seven سبعة

**Tt**

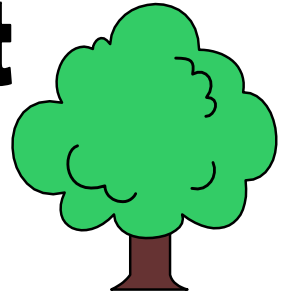

tree شجرة

**Mr Ragab**

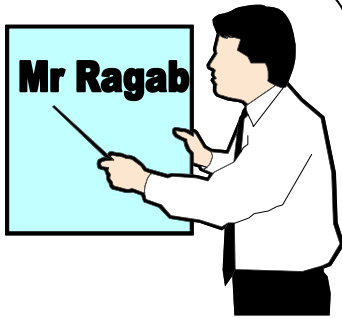

teacher مدرس

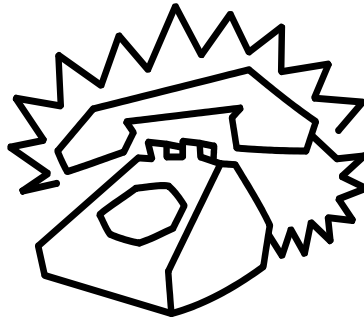

telephone تليفون

**Uu**



umbrella شمسية

**Vv**



vase زهرية

**Ww**



window شباك

**Xx**

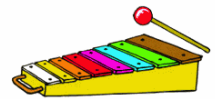

xylophone

xylophone آلة موسيقية

Yy



yoyo يويو

Zz



zoo حديقة حيوان



zebra حمار وحشي مخطط

## Songs أغاني

Leila has a little cat, a little cat, a little cat.

Leila has a little cat.

Its name is Mr Cat.



**Children:** Hello, teacher. Hello, teacher.

How are you? How are you?

**Miss Mona:** I'm fine, thank you.

I'm fine, thank you.

How are you? How are you?



Hi, rabbit! , Hi, rabbit!

Run! Run! Run!

Hi, rabbit! Hi, rabbit!

Run! Run! Run!

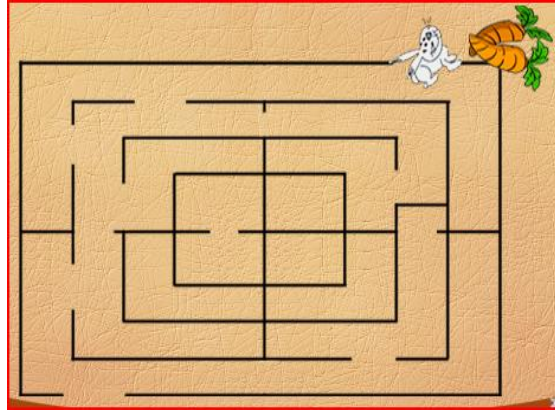

### لمفرد والجمع Singular & plural

Singular المفرد

Plural الجمع

car سيارة (واحدة)



cars سيارات



cat قطة (واحدة)



cats قطط

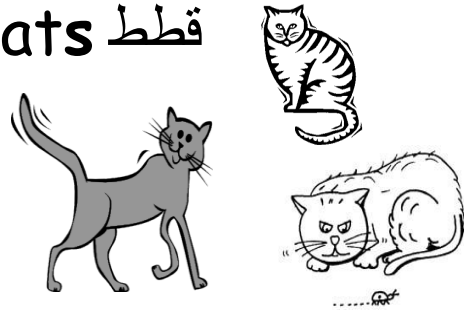

boy ولد (واحد)



boys أولاد

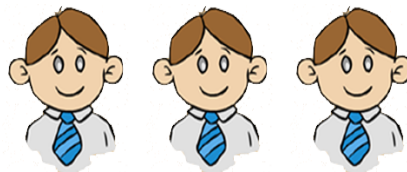

# The Alphabet



Aa Bb Cc Dd Ee

Ff Gg Hh Ii Jj Kk

Ll Mm Nn Oo Pp

Qq Rr Ss Tt Uu Vv

Ww Xx Yy Zz

# Numbers

zero <b>0</b>	one <b>1</b>	two <b>2</b>	three <b>3</b>	four <b>4</b>
five <b>5</b>	six <b>6</b>	seven <b>7</b>	eight <b>8</b>	nine <b>9</b>
ten <b>10</b>	eleven <b>11</b>	twelve <b>12</b>	thirteen <b>13</b>	fourteen <b>14</b>
fifteen <b>15</b>	sixteen <b>16</b>	seventeen <b>17</b>	eighteen <b>18</b>	nineteen <b>19</b>
twenty <b>20</b>	twenty-one <b>21</b>	twenty-two <b>22</b>	twenty-three <b>23</b>	twenty-four <b>24</b>
twenty-five <b>25</b>	twenty-six <b>26</b>	twenty-seven <b>27</b>	twenty-eight <b>28</b>	twenty-nine <b>29</b>
thirty <b>30</b>	forty <b>40</b>	fifty <b>50</b>	sixty <b>60</b>	seventy <b>70</b>
eighty <b>80</b>	ninety <b>90</b>	a hundred <b>100</b>	two hundred <b>200</b>	three hundred <b>300</b>
four hundred <b>400</b>	five hundred <b>500</b>	six hundred <b>600</b>	seven hundred <b>700</b>	eight hundred <b>800</b>
nine hundred <b>900</b>	a thousand <b>1000</b>			