



# **Reading Strategies**

Dr. Ammar Sultan Al-Ma'ani

KFU - Faculty of Art  
Distance Education  
English Language

**3rd Semester**



## Lecture 1

### ❖ Getting Meaning From Context

When you read, you don't want to look up the meanings of all new words in a dictionary. You can often guess the meaning. Here are three ways that will help you to guess new words:

#### 1. Punctuation: ( ) (-) , ; :

There is a drawback, a disadvantage, to that idea.

(Drawback means disadvantage)

e.g. Full-color pictures are printed using only black and three colors: yellow, cyan (a light blue) and magenta (a light purple)

an unfamiliar word = cyan and magenta

signal punctuation = ( )

meaning : cyan = a light blue and magenta = a light purple

#### 2. A clue in another Sentence: (surrounding words)

A school system in one country is not identical to the system in any other country. It cannot be exactly the same because each culture is different.

(in the second sentence, you see the meaning of identical – exactly the same)

#### 3. Logic:

The educational system is a mirror that reflects the culture.

(you probably know the word mirror, so you can guess that reflects means shows)

### ❖ Guess The Meaning

1- In a number of countries, education is both compulsory-required-and universal, available to everyone, at least in primary school (elementary school.)

Compulsory = Required Universal = Available to everyone

Primary = Elementary

2- Public schools are all both free and egalitarian; all students are considered equal and learn the same the same material. Egalitarian = Equal

### ❖ Identifying the Main Idea

HOW TO IDENTIFY THE QUESTION	What is the topic of the passage? What is the subject of the passage? What is the main idea of the passage? What is the author's main point in the passage? With what is the author primarily concerned? Which of the following would be the best title?
WHERE TO FIND THE ANSWER	The answer to this type of question can generally be determined by looking at the first sentence of each paragraph.
HOW TO ANSWER THE QUESTION	1. Read the first line of each paragraph. 2. Look for a common theme or idea in the first lines. 3. Pass your eyes quickly over the rest of the passage to check that you have really found the topic sentence(s). 4. Eliminate any definitely wrong answers and choose the best answer from the remaining choices.

▪ **Example**

**Here is a paragraph to consider. Look for the main idea of this paragraph:**

The life of a doctor is not easy. Martin works a very long day, and he is very busy with a variety of activities. He spends a lot of time with people, but he also spends a lot of time working on reports in his office.

**What is the main idea of this paragraph?**

If you said that the life of a doctor is not easy, you are correct

▪ **Another Example.**

The CNA's in this office can't always come to work on the same schedule each week. Sometimes they have to talk to each other and work out differences in the schedule. They usually can do this without any trouble. Ben, Victoria, and Alex work together very well.

**What is the main idea of the paragraph?**

If you said that they can all work together well, you are correct.

❖ **Skimming for the topic & Main Idea**

Hint: Remember that the topic is just a word or noun phrase – a few words. It is not a sentence.

- The main idea is in a sentence or two and can be found at the beginning, middle, or end of a paragraph.
- Each Paragraph has a main idea.

<sup>1</sup>Do you have a favorite season? <sup>2</sup>Winter, fall, and spring have many advantages. <sup>3</sup>However, summertime is my favorite season because it offers the tranquility of the beach as well as the exhilaration of outdoor sports. <sup>4</sup>First, sitting on the other side of a sand dune, hidden by sea oats and sedge, I like looking at the Atlantic Ocean, scanning for dolphins and pelicans. <sup>5</sup>Looking at something larger than I am gives me a sense of awe and gratitude and provides a backdrop for some deep musings. <sup>6</sup>Second, summertime provides me with the chance to go sailing, surfing, and hiking along the shore. <sup>7</sup>The exercise enhances my sense of well being and creates a feeling of optimism.

**The topic of the paragraph is**

- a. sailing and surfing.                      b. summertime.    ✓  
c. seasons at the beach.                  d. ways to develop optimism.

**The main idea of the paragraph is**

- a. sentence 1.              b. sentence 2.    ✓              c. sentence 3.              d. sentence 4.

❖ **understanding Pronoun Reference**

Because a pronoun REFERS to a noun or TAKES THE PLACE OF that noun, you have to use the correct pronoun so that your reader clearly understands which noun your pronoun is referring to. Therefore, pronouns should:

**1- Agree in number**

If the pronoun takes the place of a singular noun, you have to use a singular pronoun.

If a student parks a car on campus, he or she has to buy a parking sticker.

(NOT: If a student parks a car on campus, they have to buy a parking sticker)

**HINT Remember:**

**The words:** everybody, anybody, anyone, each, neither, nobody, someone, a person, etc. are singular and take singular pronouns.

**Examples:**

Everybody ought to do his or her best. (NOT: their best)

Neither of the girls brought her umbrella. (NOT: their umbrellas)

**2- Agree in person**

If you are writing in the "first person" (I), don't confuse your reader by switching to the "second person"

(you) or "third person" (he, she, they, it, etc.). Similarly, if you are using the "second person," don't switch to "first" or "third".

When a person comes to class, he or she should have his or her homework ready.

(NOT: When a person comes to class, you should have your homework ready)

❖ **Choosing the Correct Pronoun**

Circle the pronoun that agrees in number with its antecedent in each sentence.

1. Each of the girls makes (**her**, their) own clothes.
2. The jury finally made (**its**, their) decision.
3. It often seems that television programmers are not concerned with (its, **their**) viewers.
4. Both Tim and Tony write (his, **their**) mothers twice a week from camp

❖ **Understanding Pronoun Reference**

HOW TO IDENTIFY THE QUESTION	The <b>pronoun</b> "...." line X <b>refers</b> to which of the following?
	Look at the word X. Click on the word or phrase that X refers to.
WHERE TO FIND THE ANSWER	The line where the pronoun is located is given in the question. The noun that the pronoun refers to is generally found before the pronoun.
	The pronoun is highlighted in the passage. The noun that the pronoun refers to is generally found before the pronoun
HOW TO ANSWER THE QUESTION	<ol style="list-style-type: none"><li>1. Locate the pronoun in the passage.</li><li>2. Look before the pronoun for nouns that agree with the pronoun.</li><li>3. Try each of the nouns in the context in place of the pronoun.</li><li>4. Eliminate any definitely wrong answers and choose the best answer from the remaining choices.</li></ol>

❖ **Vocabulary: Recognizing Word Meanings**

- |              |                |                                  |
|--------------|----------------|----------------------------------|
| 1. <u>H</u>  | Determine      | A. Unusual                       |
| 2. <u>I</u>  | Afford         | B. Disadvantage                  |
| 3. <u>J</u>  | Reflect        | C. Side, Part, Or Characteristic |
| 4. <u>A</u>  | Nontraditional | D. Developing New Ideas          |
| 5. <u>B</u>  | Drawback       | E. Fact In The Form Of A Number  |
| 6. <u>E</u>  | Statistic      | F. Control                       |
| 7. <u>F</u>  | Discipline     | G. Whole                         |
| 8. <u>C</u>  | Aspect         | H. Decide On                     |
| 9. <u>L</u>  | Involves       | I. Have Enough Money For         |
| 10. <u>K</u> | Tuition        | J. Show                          |
| 11. <u>G</u> | Entire         | K. Fees (Money) For School       |
|              |                | L. Includes                      |

## Lecture 2

### Getting Meaning From Context

❖ **Here are another three ways that will help you to guess new words:**

1. The words for example, for instance, such as, and among them:

Example: Almost four billion people will be living in cities in developing countries such as India and Nigeria.

Meaning: Developing Countries: not rich country

2. Sometimes another word or words in another sentence or sentence part has the opposite meaning from a new vocabulary item:

Example: In some cities, instead of worsening, urban life is getting much better.

Worsening = much better

3. A definition or explanation follows the connecting words that is or in other words

**Example:** The downtown shopping area is now a pedestrian zone-in other words, an area for walkers only, no cars. A pedestrian zone is an area for walkers only.

❖ **Let's Do it Together**

People spend hours in gridlock –that is, traffic so horrible that it simply doesn't move – when the commute. Gridlock = traffic so horrible.

Under his leadership, city planners established priorities – in other words, a list of what was most important. Priorities = a list of what was most important

❖ **Identifying the Main Idea**

HOW TO IDENTIFY THE QUESTION	<p>What is the <b>topic</b> of the passage?</p> <p>What is the <b>subject</b> of the passage?</p> <p>What is the <b>main idea</b> of the passage?</p> <p>What is the author's <b>main point</b> in the passage?</p> <p>With what is the author <b>primarily concerned</b>?</p> <p>Which of the following would be the <b>best title</b>?</p>
WHERE TO FIND THE ANSWER	The answer to this type of question can generally be determined by Looking at the first sentence of each paragraph.
HOW TO ANSWER THE QUESTION	<ol style="list-style-type: none"> <li>1. Read the first line of each paragraph.</li> <li>2. Look for a common theme or idea in the first lines.</li> <li>3. Pass your eyes quickly over the rest of the passage to check that you have really found the topic sentence(s).</li> <li>4. Eliminate any definitely wrong answers and choose the best answer from the remaining choices.</li> </ol>

❖ **Supporting Details Identifying**

- Specific Details (facts, ideas, and examples) that support and develop the main idea.
- Let's go and read the following passage to identify the main idea, the supporting details of each idea and the conclusion.

### ❖ Identifying the Main idea & Supporting Details

Why I Want to Learn English (1) there are three reasons why I want to learn English. (2) One reason is that English has become an international language.(3) It is now used by most international companies, including the company where I work, for business communication. (4) Another reason why I want to learn English is so that I can travel to English-speaking countries. (5) The United States, England, Australia and many other countries all use English as their primary language. (6) Finally, I want to learn English because I plan to move to the U.S. in the future. (7) I will become a manager for my company soon. (8) For all these reasons, I am very excited about learning English.

Identify the topic sentence: Why I want to learn English

Identify the conclusion: I'm very excited about learning English

Identify the first main point: Sentence 2: One reason is that English has become an international language

Identify the second main point: Sentence 4: Another reason why I want to learn English is so that I can travel to English-speaking countries.

Identify the third main point: Sentence 6: Finally, I want to learn English because I plan to move to the U.S. in the future.

Identify the support detail for the first main point: Sentence 3: It is now used by most international companies, including the company where I work, for business communication

Identify the support detail for the second main point: Sentence 5: The United States, England, Australia and many other countries all use English as their primary language.

Identify the support detail for the third main point: Sentence 7: I will become a manager for my company soon.

### ❖ Understanding Italics

It's used:

1. Emphasis

**Example:** Overcrowding is a *huge* problem in that city.

2. A foreign word in an English sentence

**Example:** In open areas in Seoul, *Kaenari* blooms everywhere in the spring.

### ❖ Understanding Contrast

- Sometimes writers use contrast to express an idea. In other words, they begin with the opposite of the point that they want to make.
- You use contrast clauses when you want to make two statements, one of which contrasts with the other or makes it appear unexpected or surprising. Some contrast clauses – called concessive clauses – are introduced by conjunctions such as **although, even though or while**.
- Let's Go and see the following example

**Eg: Although** Mrs. Sims had lived in Hong Kong all her life, she knew very little Cantonese.

### ❖ Hint: Contrast

-Don't use **but** in sentences beginning with **although, even though or while**. Here is a mistake:

**Although** Kelvin worked hard, **but** he failed the examination.

-You will sometimes see the word **albeit** used in formal English. **Albeit** can come before an adjective, adverb, or adverbial phrase.

### Example:

Jayne participated in the charity walk, **albeit** rather reluctantly.

### ❖ Scanning

Scanning is often confused with skimming, but is in fact a distinct reading strategy involving rapid but focused reading of text, in order to locate specific information, e.g. looking for particular details such as dates, names, or certain types of words. It is processing print at a high speed while looking for answers to specific questions. When you scan, you must begin with a specific question which has a specific answer.

Scanning for information in this way should be both fast and accurate.

### ❖ Let's Do Scanning

#### Pulp Friction

Every second, 1 hectare of the world's rainforest is destroyed. That's equivalent to two football fields. An area the size of New York City is lost every day. In a year, that adds up to 31 million hectares – more than the land area of Poland. This alarming rate of destruction has serious consequences for the environment; scientists estimate, for example, that 137 species of plant, insect or animal become extinct every day due to logging. In British Columbia, where, since 1990, thirteen rainforest valleys have been clear cut, 142 species of salmon have already become extinct, and the habitats of grizzly bears, wolves and many other creatures are threatened. Logging, however, provides jobs, profits, taxes for the government and cheap products of all kinds for consumers, so the government is reluctant to restrict or control it.

#### **1. How many species of salmon have become extinct in BC?**

- a. 27                      b. 31                      c. 137                      d. 142     ✓

Much of Canada's forestry production goes towards making pulp and paper. According to the Canadian Pulp and Paper Association, Canada supplies 34% of the world's wood pulp and 49% of its newsprint paper. If these paper products could be produced in some other way, Canadian forests could be preserved. Recently, a possible alternative way of producing paper has been suggested by agriculturalists and environmentalists: a plant called hemp.

#### **2. How much of the world's newsprint paper is supplied by Canada?**

- a. 31%                      b. 49%     ✓                      c. 34%                      d. 19%

However, there is a problem: hemp is illegal in many countries of the world. This plant, so useful for fibre, rope, oil, fuel and textiles, is a species of cannabis, related to the plant from which marijuana is produced. In the late 1930s, a movement to ban the drug marijuana began to gather force, resulting in the eventual banning of the cultivation not only of the plant used to produce the drug, but also of the commercial fibre-producing hemp plant. Although both George Washington and Thomas Jefferson grew hemp in large quantities on their own land, any American growing the plant today would soon find himself in prison -- despite the fact that marijuana cannot be produced from the hemp plant, since it contains in the drug.

#### **3. What drug can be obtained from a relative of hemp?**

- a. Cocaine                      b. heroin                      c. Amphetamine                      d. marijuana     ✓



## Lecture 3

### Campus Life is Changing. Chapter One

#### A

For many years in the United States, most undergraduate students (in their first four years of college) were 18 to 22 years old. They attended college full-time, lived in a dormitory on campus, and expected many “extras” from their colleges, not just classes. But things began to change in the 1970’s, and are very different now. Today, these “traditional” students are less than one-quarter (1/4) of all college students. These days the nontraditional students are the majority; they are different from traditional undergraduates in several ways. They are older. Many attend college part-time because they have families and jobs. Most live off campus, not in dormitories. These traditional students don’t want the extras that colleges usually offer. They aren’t interested in the sports, entertainment, religious groups, and museums that are part of most U.S. colleges. They want mainly good-quality classes, day or night, at a low cost. They also hope for easy parking, access to information technology, and polite service. Both time and money are important to them.

1. What is the Topic The difference between traditional and nontraditional students.?
2. What is the Main Idea ? The difference between traditional and nontraditional students.
3. According to the passage, how today students are different from traditional students?
  - ☺ Non-traditional students are the minority F.
  - ☺ Non-traditional students are not working these days. F
  - ☺ Non-traditional students live on campus. F
  - ☺ Non-traditional students are majority and part-timers T

As you read, it’s important to begin noticing words that often go together. Go back to A paragraph. Find words to complete the following phrases and write them in the blanks. Most are prepositions.

#### **Paragraph A**

Lived in a dormitory on campus.

Many attend college part-time (verb)

Access to information technology

**Look back at the reading selection “Campus Life is Changing” to find the meanings of the following pronouns. What does each pronoun refer to?**

They (Paragraph A, line 2 ) students

They (paragraph A, line 6 ) students

Them (Paragraph A, line 12) nontraditional students

**B**

Psychological test reflect different learning styles in this new student population, too. Each person has a certain learning style, and about 60 percent of the new students these days prefer the sensing style. This means that they are very practical. They prefer a practice-to-theory method of learning, which is experience first and ideas after that. They often have difficulty with reading and writing and are unsure of themselves. Most of these students are attending college because they want to have a good job and make a lot of money.

1. What is the Topic ? Learning styles in students' population
2. What is the Main Idea ? Each person has a certain learning style, and about 60 percent of the new students these days prefer the sensing style
3. According to the passage, what do 60 percent of the new students prefer these days ?
  - a. They prefer a practice – to- theory method of learning.
  - b. They prefer a theory-to-practice theory method of learning. ✓

**C**

In contrast other students (but not as many) prefer the intuitive learning style. These students love ideas. They prefer a theory-to-practice method of learning and enjoy independent, creative thinking. These “intuitive” are not very practical. They are attending college because they want to create unique works of art or study philosophy or someday help in the field of science.

1. Topic: Intuitive learning styles
2. Main Idea : Students prefer a theory-to-practice method of learning and enjoy independent, creative thinking

**D**

There is a drawback for the students who prefer the sensing style of learning. A majority of college professors prefer the intuitive learning style. These teachers value independent thinking and creative ideas. Students in the sensing group are at a disadvantage because their way of thinking doesn't match their teachers'.

1. Topic : The sensing style of learning
2. Main idea : A majority of college professors prefer the intuitive learning style

Words in phrases : Paragraph D:

are at a disadvantage.

Understanding Pronoun References: Their (Paragraph D, line 4 students )

## F

On all college campuses, student life is very different from what it used to be because of technology – specifically, the internet. At most colleges, all entering first-year students receive an email address. Dormitory rooms offer high-speed Internet access. Computer systems are available to everyone in computer labs, the library, and student centers. Application for classes and registration are usually now possible online. Most schools offer entire courses online. Many professors still have “office hours,” when students can come to talk with them about class work or ask for help. But increasingly, students can contact professors 24 hours a day, thanks to email. In many classes, students complete assignments and even take exams online. Perhaps most important for both students and professors, research is now easier and faster because of the new technology.

1. **Topic :** *Technology in students' life*
2. **Main Idea :** *The importance of technology in college campus*

Understanding pronoun references: Them (paragraph F, line 6)

Words in phrases: As you read, it's important to begin noticing words that often go together. Go back to F paragraph. Find words to complete the following phrases and write them in the blanks. Most are prepositions.

1. Life is different because *of* technology
2. Are available *to* everyone
3. Students *take* exams (verb)

**Section: B** Directions: Read the following paragraphs and choose the correct main idea for each paragraph

## E

“There are several events that can change the Earth's surface very quickly. Volcanoes can erupt and spread lava, rock and ash for several miles. Earthquakes can leave large cracks in the Earth's surface”.

**What is the main idea?**

1. Several events can change the Earth's surface.
2. Earthquakes can cause large cracks.
3. Volcanoes can be dangerous.
4. Earthquakes

## F

“Most of the world's volcanoes are part of the "The Ring of Fire." This is a ring of volcanoes that form a circle around the Pacific Ocean. Thousands of volcanoes make up "The Ring of Fire." These volcanoes formed the sea floor and many underwater mountains’.

**What is the main idea?**

1. There are thousands of volcanoes in the world.
2. Most volcanoes are part of the "Ring of Fire".
3. Some underwater mountains are volcanoes.
4. The Ring of Fire

1) On the one hand, there are many advantages to this system. On the other hand, there are also several drawbacks.

On the one hand = *from one point of view*

On the other hand = *From another point of view*

2) In a number of countries, education is both compulsory – required- and universal, available to everyone, at least in primary school (elementary school)

Compulsory = *Required*

Universal = *Available to everyone*

Primary school = *Elementary*

3) There are many more schools in cities than in rural areas.

Rural = *areas outside the cities [countryside]*

4) Public schools are all both free and egalitarian; all students are considered equal and learn the same material.

Egalitarian = *Equal*

5) College students need great discipline; in order to make time for their studies, they need the self-control to give up hobbies, sports, and social life.

Discipline = *Self-control*

6) Results on these exams affect the entire family because there is high status, or social position, for a whole family in which children have high test scores.

Entire = *Whole*

Status = *Social Position*

7) Students themselves decide if they want college-preparatory or vocational classes in high school; no national exam determines this for them.

Determines = *Decides*

## Lecture 4

### Reading Passages Practice

#### A City That's Doing Something Right

There's good news and bad news about life in modern cities—first, the bad. People who study population growth predict a nightmare by the year 2025: the global population will be more than 8 billion, and almost 4 billion of these people will be living in cities in developing countries such as India and Nigeria. Population growth is already causing unbelievable overcrowding. Due to overcrowding, these cities have problems with air pollution, disease, and crime. People spend hours in gridlock—that is, traffic so horrible that it simply doesn't move—when they commute daily from their homes to their work and back. There isn't enough water, transportation, or housing. Many people don't have access to health services or jobs. Now the good news: in some cities, instead of worsening urban life is actually getting much better.

- **What does developing countries mean?** Poor countries
- **What does gridlock mean?** Traffic so horrible
- **What does predict mean?** To say in advance that something will happen
- **What does commute mean?** moving from - to -
- **What does worsening mean?** getting worse

#### Paragraph B: A City and Its Mayor

It might not be a surprise to find that life in affluent cities is improving. But what about cities that aren't rich? The city of Curitiba, Brazil, proves that it's possible for even a city in a developing country to offer a good life to its residents. The mayor of Curitiba for twenty-five years, Jaime Lerner, was an architect and a very practical person. Under his leadership, the city planners established a list of priorities—in other words, a list of what was most important to work on. They decided to focus on the environment and on the quality of life. With an average income of only about \$2000 per person per year, Curitiba has the same problems as many cities. However, it also has some creative solutions.

- **Identify The Main Idea :** it's possible for even a city in a developing country to offer a good life to its residents.
- **What does affluent mean ?** Rich
- **What does priorities mean ?** a list of what's most important

#### Paragraph C: Garbage Collection

One creative solution is the method of garbage collection. In neighborhoods that garbage trucks can't reach, poor people bring bags of trash to special centers. At these centers, they exchange the trash for fresh produce—such as potatoes and oranges—or for bus tickets. At a recycling plant, workers separate bottles, plastic, and cans from other trash. Two-thirds of Curitiba's garbage is recycled, which is good for the environment. And the plant gives jobs to the poorest people, which improves their lives.

- Trash >> Garbage
- Produce >> vegetable and fruits
- What does recycling plant mean?  
separating bottles, plastic, and cans from other trash.

#### **Paragraph D. Transportation**

Due to careful planning, Curitiba does not have the same traffic problems that most cities have. The statistics are surprising. The population has grown—now twice the size it was in 1974—but traffic has actually decreased 30 percent. Curitiba needed a mass-transit system but couldn't afford an expensive subway. City planners began, instead, with an unusual system of buses in the center lanes of five wide major streets.

- **What does a mass-transit mean?**

#### **Paragraph E: The Environment**

To make the environment both cleaner and more beautiful, Curitiba has strict laws against polluters. But it also has low taxes for companies that have green areas, so several hundred major industries such as Pepsi and Volvo have offices in the city. Bringing natural beauty into the city is a priority. For this reason, Curitiba gave 1.5 million young trees to neighborhoods to plant and take care of. And the downtown shopping area is now a pedestrian zone—in other words, for walkers only, no cars—and is lined with gardens.

- **What does pedestrian zone means?** Area for walkers only -no cars-

#### **Paragraph F: A Symbol of the Possible**

Clearly, overcrowding in big cities worldwide is the cause of serious problems. However, the example of Curitiba provides hope that careful planning and creative thinking can lead to solutions to many of them. Curitiba is truly, as Lewis Mumford once said of cities in general, a "symbol of the possible.

- **Find a sentence in the conclusion which seems to mean about the same main idea of the whole passage.**

#### **Building Syndrome-Sick Paragraph A:**

Elizabeth Steinberg was a healthy sixteen-year-old student on the tennis team at St. Charles High School, west of Chicago, Illinois. But in the fall of 1977, he started to have strange health problems. The same thing happened to dozens of teachers and students at the school. They went to doctors for treatment of a number of symptoms such as sore throats, tiredness, headaches, and respiratory (breathing) difficulties. Doctors treated respiratory infections with antibiotics, but the condition didn't seem to improve, except—mysteriously—on weekends and over vacations, when the symptoms disappeared. Experts came to investigate and find the cause. They discovered that St. Charles High, like thousands of other schools and office buildings nationwide, is a "sick building"—in other words, a building that creates its own indoor air pollution.

- **Topic :** Health problems
- **Main Idea :** All students in school have the same problem after years
- **Understanding Pronoun Reference:** They (A, Line 4) Teachers and students

### Paragraph B

People have worried about smog for many years, and the government has spent billions of dollars to try to clean up the air of big cities. But now we find that there is no escape from unhealthy air. Recent studies have shown that air inside many homes, office buildings, and schools is full of pollutants: chemicals, mold, bacteria, smoke, and gases. These pollutants are causing a group of unpleasant and dangerous symptoms that experts call "sick-building syndrome." First discovered in 1982, sick-building syndrome most often includes symptoms similar to the flu (watering eyes, headaches, and so on) and respiratory infections such as tonsillitis, bronchitis, and pneumonia.

- **Topic:** Causes and symptoms of sick-building syndrome
- **Topic sentence:** there is no escape from unhealthy air
- **What is the closest meaning to the word "Several?"** many
- **Understanding pronoun reference:** these (par b, line 5) pollutants: chemicals, mold, bacteria, smoke, and gases

### Paragraph C

Although most common in office buildings and schools, the indoor pollution that causes sick-building syndrome can also occur in houses. Imagine a typical home. The people who live there burn oil, wood, or gas for cooking and heating. They might smoke cigarettes, pipes, or cigars. They use chemicals for cleaning. They use hundreds of products made of plastic or particleboard—that is, an inexpensive kind of board made of very small pieces of wood held together with a chemical. These products give off chemicals that we can't see but that we do breathe in. In some homes, carbon monoxide from cars in the garage can enter the house. And in many areas, the ground under the building might send a dangerous gas called radon into the home. The people in the house are breathing in a "chemical soup".

- **Topic: Topic Sentence or main idea:** Sick-building syndrome can also occur in houses
- **Topic Sentence or main idea:** Sick-building syndrome can also occur in houses
- **Understanding Pronoun Reference:**
  - a. they (paragraph c, line 3) People
  - b. them (paragraph c, line) --

### Paragraph D

There are several solutions to the problem of sick-building syndrome, among them cleansing the building. First, of course, experts must determine the specific cause in any one building. Then workers probably need to take out carpets, wallpaper, and ceiling tiles in order to remove mold and bacteria. Also, they need to clean out the air conditioning system and completely rebuild the system of ventilation. They should remove synthetic products and bring in natural products, instead, if they are available.

- **Topic:** Several solutions to the problem of sick-building syndrome
- **Main idea:** Several solutions to the problem of sick-building syndrome
- **Understanding Pronoun Reference:** them (line 1) Solutions
- **Understanding pronoun reference :** they ( line5) Workers

## ❖ Understanding Parts of Speech

W	Verb	Adjective	Adverb
Beauty, beautification	Beautify	Beautiful	Beautifully
Creation		Creative	Creatively
Crowd		Crowded	X
Difference		Different	Differently
	X	Difficult	X
Efficiency	X	Efficient	
Pollution, pollutant	Pollute		X
	Predict	Predictable	Predictably
Safety	Save		Safely
	Solve	Solvable	X
x	Worsen	worse	

Next complete each sentence below with words from the preceding chart. Use the correct form of the base word and write the part of speech in the parentheses after each blank – (n) for noun, (v) for verb, (adj) for adjective, and (adv) for adverb.

- Solve** They are trying to find a solution (n.) to the problem of overcrowding, but this is a difficult problem to solve (v.).
- Pollute** Most people know about air pollution (n.) in big cities, but they're just beginning to learn about the many pollutions (n.) that we have inside buildings.
- Crowd** There are crowds (n.) of people everywhere ; the mass-transit system is especially crowded (adj.).
- Save** The city is not safe (adj) because of crime. People can't leave their homes safely (adv) at night, and the police can't provide for their safety ( n ).
- Beautify** Many people bring plants into their homes because the plants are beautiful ( adj ). However, it's possible that these plants not only beautify (n) the environment but also clean the air.
- Differ** The causes of indoor air pollution differ (v.) from area to area. One reason for the difference (n) is that people heat their homes differently (adv.). People in some areas burn wood for heat; in other areas, they use something different (adj).



## Lecture 5

### Getting Meaning from Context

#### ❖ Definition

A definition gives the meaning of words. The writer may use words, phrases, or statements to define something. The writer will use key words, or signal words to identify a definition so you need to look for them. See examples of key words below.

**Key words** is/are means/mean  
is/are called what this means is  
is/are known as consist of  
is/are defined as refer to  
is/are described as may be seen as

e.g.

Someone who explores and studies caves is known as **a spelunker**.

an unfamiliar word = spelunker

signal words = is known as

definition = someone who explores and studies caves

#### Exercise 1

Use signal words as your clues to find the meaning of the underlined words. Circle signal words and write their meaning in the space provided.

- The encyclopedia defines **astrology** as “the ancient art or science of divining the fate and future of human beings from indications given by the positions of stars and other heavenly bodies”.  
astrology means An ancient art or science
- **Sales literature** means printed matters that contain information on the goods.  
Sales literature means printed matters that contain information on the goods
- The part at the back of the car used for holding luggage is called the **car boot** in United Kingdom, whereas Americans would refer to this as the car’s trunk.  
car boot means The part at the back of the car used for holding luggage

#### ❖ Restatement

The writer may use other words, phrases, or sentences to provide the meaning of difficult words. We call this restatement; the writer describes it again or in a different way. Signal words for restatement are in the “Key words box” below.

•e.g.

The surface of Africa consists mainly of plateaus, or large flat areas, although these occur at different level

**an unfamiliar word = plateaus**

**signal word = or**

**meaning = large flat areas**

or
that is to say
in other words
i.e. or that is

## Exercise 2

Use signal words as your clues to find the meaning of the underlined words. Circle signal words and write

the meaning in the space provided.

1. According to Indian custom, a great dowry of money and objects is given to the bridegroom, in other words, it is a **dot**.

Dot = a great dowry of money and objects that is given to the bridegroom

2. There are several types of aerosol cans. Simple ones contain a liquefied gas, called the propellant, in which material is **dissolved**, i.e., melt.

dissolved = melt

3. Our youth nowadays should not **engage** in intoxicating things such as alcohol, cigarettes, and tranquilizers, that is to say, they should not ingest them.

Engage = ingest

### ❖ Punctuation marks

Punctuation is used to describe the meaning of unfamiliar words. The writer will write unfamiliar words and then use punctuation, words, phrases, or sentences to explain the meaning of the new words. Such punctuation is in the “Key words box” below.

• e.g.

Full-color pictures are printed using only black and three colors: yellow, cyan (a light blue) and magenta (a light purple)

- an unfamiliar word = cyan and magenta  
signal punctuation = ( )
- meaning : cyan = a light blue and magenta = a light purple
- The use of computers to handle text, or word processing, was foreseen in the 1950s.
- an unfamiliar word = handle text  
signal punctuation, , =  
meaning : handle text = word processing

, commas
, , appositive
( ) parentheses
? ? dashes
; semicolon
: colon

## Exercise 4

Use signal words as your clues to find the meaning of the underlined words. Circle signal words and write

the meaning in the space provided.

- Both facsimile (known as fax) and electronic mail (email) are ways of sending documents.

Facsimile = e-mail

Electronic mail =

- An FM radio DJ (disk jockey) broadcasts over the airwaves.

DJ = disk jockey

- Infection - becoming ill through contact with bacteria - of the respiratory system such as the nose, the throat, and the chest is among the most common of all diseases.

Infection = becoming ill through contact with bacteria

❖ **Examples**

help us to understand the meaning of new words.  
See key words or signal words used for showing examples in the “Key words box”.

such as
like
for example, ...
for instance
is / are

**e.g. Use navigation buttons**, such as, the “Next” button, the “Previous” button, the “Menu” button, and the “Exit” button, to go back and forth or jump to other topics while you are using your English software.

**unfamiliar words = navigation buttons**

**signal word = such as**

**meaning = buttons on computer program that are used for turn on pages**

**Exercise 5**

Use signal words as your clues to find the meaning of the underlined words by choosing the best answer for each question. Circle signal words.

1. Some people in the North of Thailand do wickerwork, for example, they make elephants, turtles, plates, beds, and chairs, from teak trees for earning money.

- a) silver handicraft      b) bronze handicraft
- c) niello handicraft      d) wood handicraft ✓

2. The Savanna grasslands are the home of grazing animals such as elephants, giraffes, antelopes and zebras. Lions, leopards and hyenas also live there.

- a) non-backbone animals      b) meat-eating animals
- c) invertebrate animals      d) grass-eating animals ✓

3. A tourist guide advised them to see the elephant round up. There was racing, colorful war procession, marching, kicking a ball and tug-of-war between men and elephants.

- a) show ✓      b) breed      c) sleep      d) born

❖ **Contrast**

You can guess the meaning of new words by using signal words of contrast. They will show the opposite meaning of the new words. See key words or signal words of contrast in the “Key words box”.

<b>Key words</b>
<b>but instead of even though in contrast to</b>
<b>yet in spite of although as opposed to</b>
<b>unlike despite however on the other hand</b>
<b>whereas fond of still provided that</b>

e.g.

Although Dara and Vipa are very close friends but they are very different. Suda spends a lot of money to buy things while Vipa loves to economize.

- a) spend more money                      b) save money ✓  
c) buy things more than before        d) keep things in a safe place

### Exercise 6

Use signal words as your clues to find the meaning of the underlined words by choosing the best answer for each question. Circle signal words.

1. Ladda was promoted to be the chief secretary of the manager of the company, whereas her colleague, Somechai, was penalized.

- a) promoted              b) punished ✓              c) exiled              d) Rewarded

2. Although small pox has almost been eradicated. Malaria is prevalent in Kanchanaburee, Thailand. A policeman just died from the PF (Plasmodium Falsiparum) malaria last month.

- a) destroyed completely ✓              b) common found              c) fear of disease              d) Furbish

3. The plane is scheduled to leave for Phuket at 7:00 am but the plane departure has been postponed for two hours. That is to say, it will leave at 9:00 am instead.

- a) retard ✓              b) stop              c) extend              d) went back

### ❖ Similarity

You can guess the meaning of new words by using signal words of similarity. They will display the same meaning of the new words. See key words or signal words of similarity in the “Key words box”.

Key words
like similarly in the same way
as the same as just as

e.g.

Indonesia is producing Ford cars and trucks. Soon, Thailand and Vietnam will be producing the same products with, no doubt, the same quality.

What does the words “the same products” mean? Ford cars and trucks

What is your clue ?

### Exercise 7

Use signal words as your clue to find the meaning of the underlined words. Circle signal words and write the meaning in the space provided.

- Learning should not be limited to the classroom or with teachers. We can learn by ourselves about things that are not taught by teachers. Similarly, “**self-learning**” is encouraged for our education system.

What does the words “self-learning” mean ? learn by ourselves

- Thailand and South Korea have made a break-through in developing a new technology that enables **high-speed Internet connections**, just as phone service links are made efficiently through electric power lines. Both countries have joined hands to do business.

What do the words “high-speed Internet connections” mean? broadband

❖ Pictures

“A picture is worth more than a thousand words” (an old Chinese saying) so a picture can help you to guess the meaning of a new word. Look at the pictures below and choose the best answer to explain the pictures



Which is the best description for the above picture?

- a) For Sale
- b) Equipment used in an office ✓
- c) Instruments for you



Which is the best description for the above picture?

- a) Holiday on beach ✓
- b) Beautiful beach
- c) Activity of people

## Lecture 6

**Getting Meaning from Context** Use both specific clues in these sentences and your own logic to determine the meanings of the underlined words and expressions. Then write your guess about the meaning. Compare your answers with those of a partner.

1. Twenty years ago, in many countries, people could choose their livelihood, but they couldn't usually choose to change from one profession to another.
2. Many people with temporary jobs would prefer more permanent posts.
3. Even in Japan, where people traditionally had a very secure job for life, there is now no promise of a lifetime job with the same company.
4. When they lose their job, they also lose their self-confidence, or belief in their own ability.
5. They usually need to upgrade their skills to find a new, better job.
6. Because technology changes fast, workers need continuing education if they want to keep up with the field.
7. In many professions, telecommuting is now possible. People can work at home for some—or all—of the week and communicate by computer, telephone, and fax.
8. It's difficult for some people to focus on work when they are at home. The refrigerator, TV, and their children often distract them.
9. There is an advantage to technology: customers and clients have access to businesspeople at any time and anywhere. However, there is also drawback: many businesspeople don't want to be available day and night.
10. Many people don't have time for their family, friends, or leisure activities such as hobbies, sports, or movies.
11. There are advantages and disadvantages to globalization, and we are all affected by it.
12. Some people are flexible and can adjust well to change, but others are more rigid.  
flexible: \_\_\_\_\_  
rigid: \_\_\_\_\_
13. Workaholicism is another common problem in the 21st century.

**Comparing Answers:** compare your answers in the previous activity with those of other students. Were your answers similar? Now, go back to the vocabulary chart in Activity 2. Can you check any more words?

### ❖ Strategy

#### Previewing a Reading

It helps to preview a chapter or passage before you read it so you can get an idea of what the article is about. In other words, look it over quickly to see what you can expect. Specifically, look at

- headings (the "titles" of the paragraphs), which indicate main topics
- pictures
- charts, figures, or diagrams

Previewing is a useful way to determine the usefulness of a text, how easy or difficult it will to read, and what reading speed to use to read it well.

❖ **Guidelines for Previewing Passages:**

- Read the title.
- Look at the pictures (if there are any.)
- Read the first few sentences in the first paragraph.
- Read the first line of the other paragraphs.
- Read the first and last sentences of the last paragraphs“.
- When previewing, look at tables, graphs etc as well as headings

## “Helicopters”

Reading Comprehension – Informational Passages

*Directions: Read the passage. Then answer questions about the passage below.*

Helicopters are very different from airplanes. They can do three things that airplanes cannot do. First, when airplanes move upward, they must also move forward, but helicopters can move straight up without moving ahead. Second, helicopters can fly backward, which airplanes cannot do. Third, helicopters can use their rotors to **hover** in the air (stay in one place) which is impossible for planes. Because helicopters can **perform** actions that airplanes cannot, they are used for different tasks. Since helicopters can take off without moving forward, they do not need a runway for takeoff. They are used in **congested** areas where there is no room for airplanes or in **isolated** areas which do not have airports. Because they can hover, they are used on firefighting missions to drop water on fires. They are used in logging operations to lift trees out of forests. Helicopters are used as air ambulances to airlift patients out of situations which are difficult to reach by **conventional** ambulances. The police use helicopters to follow suspects on the ground or to search for cars on the ground. Of course, helicopters have military uses because of their design and capabilities

❖ **USING THE PREFIX OVER-**

The prefix **over-** can appear as part of a noun, verb, or adjective. In some words, it indicates that there is too much of something or that someone is doing too much of a certain action.

**Example** Some people **overwork** and don't enjoy their work.

**overwork (verb) = work too much**

❖ **Using the Prefix Over-** Read the definitions below. Write the words being defined. They begin with *over*. Then compare your answers with another student's.

1. do something too much (verb) = overdo
2. a place with too many people or things; a crowded place (adjective) = congested
3. give an estimate that is too high (verb) = hover
4. left unpaid, undone, or unreturned too long, past the due date (adjective) = conventional
5. too many people in an area; a population that is too high (noun) = congestion

❖ What Are Prefixes?

- A **prefix** is a group of letters we add to the **front** of a word.
- Prefixes **change the meaning** or **purpose** of the word, e.g.

• **Un = not**

- un + kind = unkind
- unacceptable, unreal, unhappy, unmanned

• **Un = reversal or cancellation of action or state**

- unplug, unmask

✓ The prefix 'un'

- My mum was **unwell** at the weekend with a bad cold.
- Jerry seemed **unhappy** that the cat was by his hole.



✓ The prefix 'dis'

- Sally **disagreed** with Tom over who threw the snowball.

How has the word meaning been altered with this prefix?

agree-----disagree

Again the word has become an antonym (opposite) of the root word.



- Can you **disable** the alarm?

.....



Add the prefix 'un' & 'dis' to these root words!

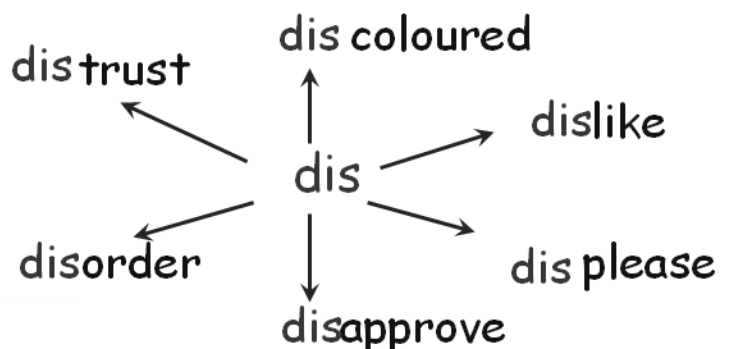
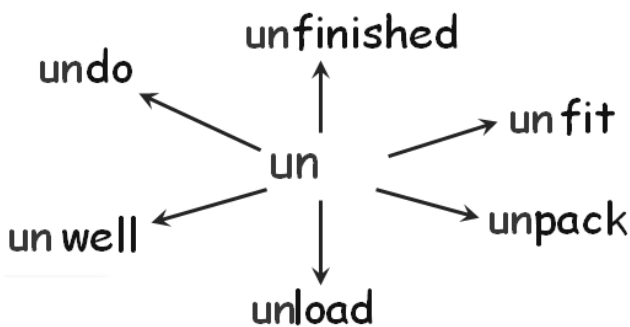

Is it 'un' or 'dis'?

un	dis
Unfit	Discharge
uncover	disappear
unwell	disobey
	Disagree
	disbelief
	disapprove



✓ **pre, de, re= 2Prefixes**

- To understand what is meant by the term 'prefix;'
  - To recognize and spell the prefixes: - **re, de** and **pre**.
- re = again**

repaint, reappraise, reawake



✓ **The prefix 're'**

- Danny had to **refill** the bucket.
- The T.V. showed an action **replay**

✓ **The prefix 'de'**

- Dad had to **defrost** the chicken before he put it in the oven
- de = down, away
- de= removal, reversal
- Descend, despair, depend, deduct
- de-ice, decamp

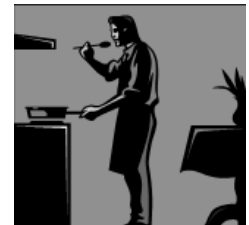

- The time to **depart** from the station had arrived



✓ **The prefix 'pre'**

- Pre = before in time, place, order or importance
- pre-adolescent, prelude, precondition
- John liked **prehistoric** animals.
- A **prefix** is fixed to the front of a word.



**To recognise and spell the prefixes: - re, de, pre, un and dis.**

- Read the sentence carefully.
- Add the correct prefix and rewrite the sentence.
- Use a dictionary to find more words with the prefixes 're' 'pre' or 'de'.

**Is it 're' or 'de' or 'pre'?**

re	de	pre
reheat	deposit	precaution
report	deface	premature
rearrange		prefix

## Lecture 7

### I. Previewing Vocabulary page 95/ 109/ 113/ 114

No.	Verb	Noun	Adjective	Adverb
1	distinguish	competitive	slang	enthusiastically
2	enroll	essence	international	suddenly
3	invest	fad (trend or fashion)	counterclockwise	
4	prevent	lifestyle	plain	
5	replace	profit	creative	
6	survive	trend	Irrational	
7	transit	experience		
8	alert	combination		
9	wear			
10	Follow			
11	found			

### II. Matching Words page 109 Ex. 4

Match words & their meanings

No.	words	definitions
1	--g- reflect	a. Among other countries
2	--i-- survive	b. Get knowledge from life
3	-c - transit	c. Moving people or things across places
4	--a- international	d. Stop something before it happens
5	--j- invest	e. Put back, provide something again
6	-b- experience	f. In the opposite direction to the hands of a clock
7	-e- replace	g. Throw back; give back an image of
8	-d- prevent	h. Joining together of people or things
9	--h- combination	i. Continue to live or exist
10	-f- counterclockwise	j. Put money into a business in the hopes of making profit

#### Exercise

**Choose the most appropriate answer:**

1. Something that is very popular and lasts for a short period of time is a -----

- a. hobby                      b. fad                       c. story                      d. meal

2. In my travels, I saw many different ----- of furniture, clothing and food.

- a. styles                       b. tests                      c. sheets                      d. cups

3. which of the following is closet in meaning to ***differentiate*** ? -----

- a. prepare                      b. enjoy                      c. apologize                      d. distinguish

4. ***Survive*** means: -----:

- a. die                      b. stay alive                       c. become tired                      d. laugh

5. The phrase To put on clothes has the same meaning as ----- clothes

- a. wear ✓                      b. buy                      c. wash                      d. keep

6. King Faisal University was established in 1975. The underlined word “ established” means:

- a. invested                      b. painted                      c. founded ✓                      d. closed

7. The rich man has ----- all his money in the new project.

- a. invested ✓                      b. invented                      c. invited                      d. interested

8. The phrase “ join officially a school or university” means: -----.

- a. pay                      b. live                      c. enroll ✓                      d. drop

9. which of the following is closet in meaning to very clear and easy to understand?

- a. plane                      b. blame                      c. brain                      d. plain ✓

10. Parents should ----- their children from watching violent movies.

- a. help                      b. prevent ✓                      c. join                      d. train

11. The phrase walk behind has the same meaning as -----

- a. run away                      b. avoid                      c. follow ✓                      d. live

### III. Common Prefixes & Suffixes

Why Learn Suffixes?

**Suffixes** add meaning to thousands of words.

Learn a few Suffixes, and you open up the meaning of thousands of words.

The four most frequent suffixes are 97% of suffixed words!

#### Most Common Suffixes

1. -able, ible = can be done : doable	1. -able	a. Past
2. -al, ial = has property of : personal	2. -al	b. Made of
3. -ed* = past verb : turned	3. -ed	c. Having
4. -en = made of : golden	4. -en	d. One who
5. -er = comparative : higher	5. -er	e. Comparative
6. -er = one who : doer, actor	6. -er	f. Can
7. -est = superlative : best, biggest	7. -est	g. Superlative
8. -ful = full of : careful, joyful	8. -ful	h. Present participle
9. -ic = having property of : linguistic	9. -ic	i. State of
10. -ing* = present participle : running	10. -ing*	j. Without
11. -(t)ion = act, process : action	11. -(t)ion	k. Having property of
12. -(i)ty = state of : infinity, sanity	12. -(i)ty	l. Full of
13. -(t)ive = adjective : motive, votive	13. -(t)ive	m. Act
14. -less = without : fearless, careless	14. -less	n. Adjective
15. -ly* = having : quickly, quietly	15. -ly*	o. Without
16. -ment = action, process : enjoyment	16. -ment	p. Action
17. -ness = state of : kindness	17. -ness	q. Having
18. -ous = having : joyous, religious	18. -ous	r. Having
19. -s* = more than one : books	19. -s*	s. Plural
20. -y = having : happy, windy	20. -y	t. State of
		u. Havin

**Can you use common affixes?**

1. I have a different idea; I disagree.
2. That can't be; it's just impossible.
3. Say that again; please repeat it.
4. Aliens look bad; they are unfriendly.
5. Tina took the car since she wanted ed it.
6. Now the car is running down the road.
7. Tina is in a hurry; she's driving quickly.
8. Do you think that she has any tickets?

**A prefix is a syllable that is added to the beginning of a word to change its meaning or its part of speech.**

**A suffix is a syllable that is added to the end of a word to change its meaning or its part of speech.**

No.	Prefix	examples	Suffix	examples
1	Dis	disadvantage	ship	,friendship
2	Im	impossible	ate	irrigate
3	In	incorrect	ful	successful
4	Ir	irregular	ic	scientific
5	Un	unimportant	ion	recreation
6	En	endanger	Less	careless
7	mis	misunderstand	al	national
8	Re	rewrite	ize	apologize

**IV. Analyzing ( suffixes & Prefixes ) pages 108/ 109**

A. *Suffixes ( page 108 ) Decide what parts of speech [ V. N. Adj or Adv ]*

No.	words	No.	words	No.	words
1	<u>N</u> friendship	9	<u>adv</u> enthusiastically	17	<u>n</u> workaholism
2	<u>adv</u> suddenly	10	<u>adj</u> expensive	18	<u>v</u> indicate
3	<u>n</u> actress	11	<u>v</u> participate	19	<u>n</u> organization
4	<u>v</u> specialize	12	<u>n</u> individualism	20	<u>n</u> pleasure
5	<u>n</u> patriotism	13	<u>v</u> summarize	21	<u>n</u> hostess
6	<u>v</u> soften	14	<u>adj</u> worthless	22	<u>n</u> experience
7	<u>n</u> simplicity	15	<u>v</u> worsen	23	<u>n</u> relationship
8	<u>adj</u> hopeless	16	<u>adv</u> Frequently	24	<u>adj</u> flexible



## Lecture 8

### Interactions 2: Reading

#### Recognizing Cause & Effect Page 79 U

**Cause**= is the reason      **Effect**= is the result

He was very sick . Salim didn't come to university

**Effect**

**Cause**

We join cause and effect in order to make one sentence by:-:

Because, as , since ----- cause or reason

As a result, there fore , consequently, so ----- effect or result

Salim didn't come because/as/since he was very sick-

Because/Since/As Salim was sick, he didn't come- .

Salim was very sick. Therefore/ So/ As a result/ Consequently, he didn't come- .

#### Sample Questions Cause & Effect Page 79 U

**1. He put on heavy clothes ----- the weather was very cold.**

- a. because    ✓                      b. as a result                      c. therefore                      d. so

**2. ----- the questions were easy, all students succeeded.**

- a. As a result                      b. Since                      ✓                      c. Consequently                      d. so

**3. My friend is very rich. ----- he has a new car and a villa.**

- a. Therefore                      ✓                      b. Since                      c. As                      d. because

**4. The doctor didn't come today. ----- the lecture was cancelled .**

- a. Because                      b. As                      c. So                      ✓                      d. Since

**5. ----- the film was boring, no one enjoyed it.**

- a. As                      ✓                      b. So                      c. Therefore                      d. As a result

**6. The food was very delicious. ----- , we ate too much.**

- a. Consequently                      ✓                      b. Because                      c. Since                      d. As

#### Information Questions

No.	Wh	Situation	Example
1	Who	Person	Who is in the car? _ Reena
2	Where	Place	Where is the book? – on the table
3	When	Time	When did you arrive? – At 12 o'clock
4	Why	Reason	Why will you leave? - Because/ I feel sick
5	Whose	Owner	Whose car is that/ - its Fawaz's
6	Which	Choice	Which lecture do you prefer? – English one.
7	What	Event or thing	What did he say? – He would not come to the party
8	How	Situation and case	How is your study? – It's good
9	How often	Number of times	How often do Muslims pray a day? – Five times
10	How long	Period	How long does it take you to arrive? – 2 hours
11	How far	distance	How far is the university from your house? – 15 Kms.

### Sample Questions ( Wh- Questions)

Circle the most suitable answer a, b, c or d for each of the following

1. ----- was the reason of the car accident? – It was the very high speed.  
A. Why                                      B. Where                                      C. What ✓                                      D. How
2. Could you please tell me ----- will be the final test ? - Next Monday.  
A. Where                                      B. When ✓                                      C. How                                      D. Who
3. ----- do you eat a day? - Only twice.  
A. How far                                      B. How long                                      C. How often ✓                                      D. How
4. How long did it take you to finish doing the homework? - -----  
A. Three kilometers                      B. Two hours ✓                                      C. Four children                                      D. Yesterday
5. \_----- is knocking at the door? \_\_ It is Rami  
A. How                                      B. When                                      C. Why                                      D. Who ✓
6. I really don't know----- the football match begins.  
A. when ✓                                      b. who                                      C. what                                      D. whose
7. How -----is the hospital from the police station? \_ Three kms.  
A. long                                      B. often                                      C. much                                      D. far ✓
8. ----- did she say? – Nothing  
A. Who                                      B. Why                                      C. What ✓                                      D. When
9. I need your help please. I don't know \_\_\_\_\_ to start this machine.  
A. who                                      B. how ✓                                      C. what                                      D. whose
10. ----- house is that beautiful one? – Its mine  
A. Who                                      B. What                                      C. Whose ✓                                      D. Where
11. ----- colour do you prefer Aysha ? – The red one  
A. Which ✓                                      B. Who                                      C. When                                      D. how
12. How ----- are you Abdullah? \_ 178 cm  
A. long                                      B. tall ✓                                      C. far                                      D. old

### Previewing Vocabulary page 122/ 123/ 131

No.	Noun	Verb	Adjective	Adverb
1	driving	fall	economic	obviously
2	corners	wash	global	
3	root	reduce	addict	
4	key			
5	climate			
6	path			
7	gap			
8	goods			
9	fuel			
10	harbor			

## Exercise

**Choose the most appropriate answer:**

1. Wash has the same meaning as -----

- a. dig                      b. clean ✓                      c. carry                      d. take

2. The word '-----' means a way.

- a. corners                      b. key                      c. climate                      d. path ✓

3. which of the following is closet in meaning to average weather condition over a long time?

- a. mountain                      b. raining                      c. climate ✓                      d. root

4. root means: -----:

- a. cause ✓                      b. solution                      c. feeling                      d. effect

5. The phrase make less has the same meaning as -----

- a. produce                      b. introduce                      c. reduce ✓                      d. keep

6. The phrase lose power has the same meaning as:

- a. fall ✓                      b. open                      c. go high                      d. close

## **Scanning & Skimming A reading passage page 119**

For the first time in history, almost the entire world is now sharing the same economic system. Communism began to fall in the late 1980s, and since then, capitalism has spread to most corners of the world. The basis of a "pure" capitalist economy is free trade, also called "open trade". There are benefits of open trade for both rich and poor countries. For developed countries such as Japan and England, free trade brings with it more competition, which in turn brings advantages such as lower prices and more choices of products for consumers.

For developing countries, open trade means that people have access to essential goods such as food, clothing, and fuel (for transportation and heat). An open economic system can be a key to improving the lives of people in both poor and rich countries because it can reduce poverty and improve living conditions.

## **Sample questions**

Choose the most appropriate answer:

1. What is the entire world now sharing ? -----

- a. The history                      b. the same economic system ✓                      c. Communism                      d. leaking boats

2. The underlined word 'benefits' means -----.

- a. corners                      b. advantages ✓                      c. goods                      d. conditions

3. Which of the following is closet in meaning to the underlined word "reduce"

- a. make less ✓                      b. increase                      c. import                      d. consume

4. The underlined pronoun "it" Line 5 refers to: -----:

- a. Japan                      b. developed country                      c. open trade ✓                      d. economy

5. When did Communism begin to fall ? -----

- a. Last year                      b. in the late 1980s ✓                      c. last week                      d. in 1980

6. What can reduce the poverty ? -----

- a. Developed countries                      b. An open economy ✓                      c. war                      d. Communism

## **Scanning & Skimming Reading Texts Page 75**

A hundred years ago, in most of the world, people didn't have much choice about the work that they would do, where they would do it, or how they would do it. If their parents were farmers, they became farmers. The society and tradition determined their profession. twenty



years ago in many countries , people could choose their livelihood . They also had the certainty of a job for life , but they usually couldn't choose to change from one employer to another or from one profession to another . Today , this is not always the case. Career councilors tell us that the world of work is already changing fast and will change dramatically in the next 25 years.

The situation varies from country to country, but in today's economy, there is generally less job security worldwide . Even in Japan , where people traditionally had a very secure job for life ,there is now no promise of a lifetime job with the same company. One reason for the lack of job security is the worldwide decrease in manufacturing jobs. Another reason is employer's need to hold down costs . This has resulted in two enormous changes for the workforce.

### **Questions**

**1. The most appropriate TOPIC for the reading passage is: -----**

- A. Career councilors  
 B. The society and tradition  
 C. Parents and farmers  
 D. Changing career trends ✓

**2. The part speech of the underlined word “ choice” is: A/ An -----**

- A. Verb  
 B. Noun ✓  
 C. Adjective  
 D. Adverb

**3. The underlined word “ varies” has the same meaning as the word: -----**

- A. carries  
 B. constructs  
 C. differs ✓  
 D. watches

**4. What determined the profession in the past was -----**

- A. the farmers  
 B. the society and tradition ✓  
 C. the people  
 D. the country

**5. The MAIN IDEA of paragraph 1 is that -----**

- A. parents were farmers  
 B. people in the past didn't work  
 C. the world of work has changed ✓  
 D. parents were farmers

**6. A country that had a very secure job is -----**

- A. Brazil  
 B. Japan ✓  
 C. U.S. A  
 D. China

**7. The lack of job security is due to -----**

- A. holding down costs ✓  
 B. Worldwide increase in manufacturing  
 C. the traditions  
 D. the same company

### **Previewing Vocabulary Pages [ 78 & 87 ]**

**1. People who give advice about professions and careers are: -----**

- A. Career councilors ✓  
 B. manufacturing jobs  
 C. drawbacks  
 D. career trends

**2. The feeling that the worker will never lose his or her job is -----**

- A. workaholism  
 B. Job security ✓  
 C. job hopping  
 D. work force

**3. The movement of jobs to places with lower salaries is -----**

- A. self-confidence  
 B. outsourcing ✓  
 C. job hopping  
 D. work force

**4. Changing from one job to another is -----**

- A. job hopping ✓  
 B. Job security  
 C. workaholism  
 D. work force

**5. The feeling of being happy and satisfied is “-----**

- A. distract  
 B. workaholism  
 C. pleasure ✓  
 D. stress

**6. He looked through the ----- ads and hoped to find his dream job.**

- A. sports  
 B. classified ✓  
 C. self  
 D. drawback

**7. The ----- rate is very high and it is difficult to find jobs.**

- A. salaries  
 B. employment  
 C. workaholism  
 D. unemployment ✓

**8. When I began job hunting, I put in my application At the ----- office of many companies.**

- A. personnel ✓  
 B. self  
 C. dream  
 D. traffic

## Lecture 9

**Skimming for the Topic and the Main Idea:** Read these paragraphs quickly. Don't worry about the details. When you finish, write the topic and main idea of each paragraph

### Looking for Work in the 21st Century

Not very long ago, when people needed to find a job, several possible steps, classified ads in the newspaper. They could go to the personnel office at various companies and fill out an application, or they could go to an employment agency. They through word-of-mouth—from another person who had heard about it.

JOBS OFFERED		REAL ESTATE	
<b>Jobs Domestic</b>	<b>8200</b>	<b>HOMES FOR SALE</b>	<b>9001</b>
<p><b>AUPAIR</b> L/I 2 kids 8 &amp; 9 House-keeping &amp; driving. H-(818)555-1890;</p> <p><b>Accounting Manager</b> Mountain Plumbing Contractor looking for an Asst to Controller. Ideal Candidate will have 3- 5 Yrs. Const. Actng/Job Costing Exp. Handling Revenues \$5MM &amp; greater. Proficiency in Windows based-computer enviroment w/Exp. in Excel/Word a must. Fax Resume to 714-555-5870 Attn: Oscar</p> <p><b>ACTORS</b> Comedians and great personalities to teach fun traffic school 16-24hrs/wk. \$12/hr. 800-555-6463</p> <p><b>Administrative Assistant</b> City office of nat'l org dedicated to helping low-income communities find creative solutions to problems of</p>		<p><b>CHEF</b>, Sushi - Select, clean, carve, &amp; prepare traditional Japanese sushi &amp; sashimi incl. tuna, yellowtail, salmon, albacore, octopus, snapper, mackerel, eel, shrimp, squid, scallops, sea urchin, smelt roe, lobster, rice, seaweed, &amp; vegetables. Requires 2 yrs exp. in job offered. \$4200/mo. 11a-2p &amp; 5-10p Wed-Sun. Interview &amp; job in Long Beach, CA. Send this ad and your resume/letter of qualifs to Job #MM057000, PO Box 1256, Sacramento, CA 95826-1256</p> <p><b>AUTOMOBILES</b></p> <p><b>Automobiles</b> <span style="float: right;"><b>9000</b></span></p> <p>'06 M Roadster Z-3 \$37,988 Silver cert. to 100K 15K Mi. (vin.LC90000) Exp. 12/31 Bob's BMW (818)555-1352</p> <p>'04 Camaro Z28 Convertible auto, 16K mi, like new. (562)555-1397</p> <p>'03 Lumina V6. Auto. 58K mi.</p>	
		<p>Older home in town. Great location, schools, shops nearby. Motivated to sell. 3BR/2BA 1300sqft. \$199k 910-555-7799</p> <p><b>BAYS COVE</b> Updated home in a great neighborhood. 3 bedrooms, 2 baths, den, fireplace with gas logs, beautiful large kitchen, over 2200 sqft. 2 car garage and large lot. Only \$269,000. Call 245-555-1930 or page</p> <p><b>OWNER FINANCING.</b> . . 2BR, 1.5 BA condo, eat-in kit., deck, 129,000.</p> <p>716 DOVER...3BR, 2BA custom built, great rm w/stone F/P, FR, 2 car gar., wooded lot. \$299,000.</p> <p style="text-align: center;"><b>B&amp;S REALTY AND AUCTION</b> 753-555-1967</p>	

**A. Topic:** Steps of finding a job.

**Main Topic:** There were several possible steps to find jobs Not very long ago.

**They** (Paragraph A, Line 2) refers to .....

**B** These days, job hunting is more complicated. The first step is to determine what kind of job you want (which sounds easier than it is) and make sure that you have the right education for it. Rapid changes in technology and science are creating many professions that never existed until recently. It is important to learn about them because one might be the perfect profession for you. The fastest-growing areas for new jobs are in computer technology and health services. Jobs in these fields usually require specific skills, but you need to find out exactly which skills and which degrees are necessary. For example, it may be surprising to learn that in the sciences, an M.S. is more marketable than a Ph.D.! In other words, there are more jobs available for people with a Master of Science degree than for people with a doctorate. (However, people who want to do research still need a Ph.D).

**Topic:** Job Hunting Steps nowadays

**Main Idea:** Job hunting has become more complicated these days

**Them** (Paragraph B, Line 11) refers to .....

**C** How do people learn about “hot” new professions? How do they discover their “dream job”? Many people these days go to a career counselor. In some countries, job hopping has become so common that career counseling is now “big business.” People sometimes spend large amounts of money for this advice. In Canada and the United States, high school and college students often have access to free vocational counseling services on campus. There is even a career organization, the Five O’Clock Club, which helps members to set goals. Members focus on this question: what sort of person do you want to be years from now? The members then plan their careers around that goal. AU career counselors—private or public—agree on one basic point: it is important for people to find a career that they love. Everyone should be able to think, “I’m having such a good time. I can’t believe they’re paying me to do this”.

**Topic:** *Career Counseling*

**Main idea:** *Job hopping has become so common that career counseling is now big business.*

**It** (Paragraph D, Line 33) refers to .....

**D** After people have determined what their dream job is, they need to find it. The biggest change in job hunting these days is the use of the Internet. More and more employers are advertising job openings on their computer websites. More and more job hunters are applying for jobs online. There are also several thousand job boards, among them HotJobs.com, Jobsjobsjobs.com, and Monster.com. Some people think that online job hunting is only for people in technology fields, but this isn’t true. Over 65 percent of online job seekers are from nontechnical fields. Even truck drivers now find jobs on the Internet!

**Topic:** *Internet and Job Hunting*

**Main idea:** *More and more job hunters are applying for jobs online.*

**It** (Paragraph D, Line 33) refers to .....

**E** So how does this work? A job seeker can reply to a “Help Wanted” notice on a company’s website. This person can also post his or her résumé (page with information about education and work experience) on one or many —of the online job boards. If a company is interested, the person still has to take the next step the old-fashioned way—actually go to the job interview and perhaps take a skills test. However, even this might soon change. In the near future, companies will be able to give the person a skills test and check his or her background (job history and education) online. But what about the interview? Companies will soon be able to interview the person by videolink, so people can interview for jobs in other cities—or even other countries— without leaving home. Clearly, job hunting is not what it used to be.

**Topic:** *Online Job Hunting Steps*

**Main Idea:** *Job hunting nowadays is not what it used to be.*

**Them** (Paragraph D, Line 36) refers to .....

**Vocabulary Previewing ( pages 123 / 131 / 135)**

No.	New words		meanings
1	harbor	N	A place by sea for ships and boats
2	gap	N	A space between two things / a difference
3	nutrients	N	Very useful food
4	obstacles	N	hindrances
5	benefits	N	advantages
6	Areas	N	places
7	detective	N	An inspector who looks for criminals
8	Look for	V	search
9	reduce	V	Make less
10	require	V	Need or want
11	astonish	V	surprise
12	Excite	V	Make happy
13	Relax	V	to rest
14	interest	N	Concern / benefit
15	Challenge	V	Stand against
16	Frighten	V	Horrify / terrify / make others feel afraid
17	Hold back	PV	Stop or prevent
18	Alone	Adj	Away from others/ nobody with him/ her

**Questions**

- The word "-----" is closest in meaning to the word "surprise".  
a. terrify      b. challenge      c. laugh      d. astonish
- If you go to the ----- you will many boats and ships.  
a. harbor       b. office      c. hospital      d. restaurant
- The word "need" is closest in meaning to the word -----  
a. question      b. visit      c. require       d. invest
- The phrase "a space/ distance between two things or persons" is a -----  
a. building      b. street      c. wall      d. gap
- The word "-----" is closest in meaning to the phrase "make less".  
a. reduce       b. widen      c. require      d. worsen
- most people prefer to ----- by the sea coast.  
a. relax       b. test      c. work      d. type
- The word "hindrances" is closest in meaning to the word -----  
a. questions      b. obstacles       c. facilities      d. stories
- The phrase "an inspector who looks for criminals" is called a/n -----  
a. detective       b. astronaut      c. teacher      d. servant

**F** Travelers who return from a vacation often answer the question “How was your trip?” by saying, “Oh, it was out of this world!” By this idiom, they mean, of course, that their trip was amazing or wonderful. However, people will soon be able to use this expression literally, but it will be expensive. Already, it’s possible to go through the same training that astronauts go through. Just go to Star City, Russia. In addition to astronaut training, it’s possible to experience one of their Space Adventures.” On one of these, for example, you can enter a special plane that gives you the feeling of weightlessness that astronauts experience—several minutes of zero-gravity. (Gravity is the force that keeps us on the Earth). Two private individuals have already spent a week at the International Space Station, at a price of \$20,000,000 each. A number of companies are now planning projects to commercialize space in various ways. A California company, Scaled Composites, and a British company, Virgin Galactica, are working on the creation of reusable vehicles that could carry passengers in the near future. Even the Hilton Hotel chain is considering building a space hotel. The main attractions will be the view (of Earth), the feeling of weightlessness, and the chance to take a hike. . . on the Moon. It goes without saying that the price will also be “out of this world.”



▲ Would you like to travel into space?

### Questions

Choose the most appropriate answer:

1. **What do the travelers who come from a vacation say about their trip?**
  - a. We were sick?
  - b. It was a long trip
  - c. Oh, it was out of the world
  - d. Oh, Nice trip
2. **The underlined pronoun “ it” line 2 refers to ----- .**
  - a. the answer
  - b. the question
  - c. the trip
  - d. this world
3. **which of the following is closest in meaning to special ? -----**
  - a. strong
  - b. enjoyable
  - c. public
  - d. private
4. **literally means: ----- :**
  - a. word by word
  - b. stay alive
  - c. unreal
  - d. wonderful
5. **How long does it take to give you the feeling of weightlessness?**
  - a. Two weeks
  - b. Three minutes
  - c. One hour
  - d. Several minutes
6. **The underlined pronoun “ their” line 3 refers to -----.**
  - a. amazing trips
  - b. people
  - c. travelers
  - d. the vacations
7. **It is clear that a trip to space is -----**
  - a. expensive
  - b. tiring
  - c. public
  - d. dangerous
8. **How much did the two individuals who stayed a week at I S S pay?**
  - a. \$20,000,000
  - b. \$40,000,000
  - c. it was free
  - d. \$10,000,000
9. **The most appropriate TOPIC of the reading passage is -----**
  - a. California Company
  - b. Travelling Into Space
  - c. Amazing Expression
  - d. Galactica
10. **The MAIN IDEA of the passage is -----**
  - a. A trip to the sea is wonderful
  - b. It is very cheap to go to space
  - c. Space travelling is now possible
  - d. No one like to travel into space

## Lecture 10

Previewing Vocabulary page 95/ 109/ 113/ 114/ 115

No.	Words	Parts of speech	meanings
1	gestures	Noun	hints
2	Pick up	PV	Choose / select or carry
3	Creatures	Noun	living things like animals and plants
4	Echo	V or N	A repeated / or sent back sound
5	claim	V or N	To demand/ advocate
6	Species	Noun	Similar kinds or sorts
7	Coin	Noun	A metal piece of money
8	Acquire	Verb	To get or obtain or win
9	Shed light on	PV	Concentrate on/_ focus on
10	upright	Adj	Honest & responsible / straight back
11	focus	V / N	Central point / concentrate
12	Capacity	N	What a container can hold
13	Respond	V	Reply/answer
14	Realize	V	Understand
15	Head of something	expression	The main point/ the centre
16	return	Verb	Give back / come back

### Questions

**1-The word “-----” is closest in meaning to the word “ hints.”**

- a. creatures    b. lectures    c. gestures     d. features

**2-Our Doctor always ----- on the meanings of new words in English.**

- a. relaxes    b. sheds light     c. types    d. types

**3-The phrasal verb “----- ” is closest in meaning to the word “return“**

- a. pick up    b. look forward to    c. give back     d. interest in

**4- I called him by phone so many times but he didn't -----**

- a. respond     b. ask    c. sleep    d. eat

**5-The word “-----” is closest in meaning to the verb “ get or obtain.”**

- a. reduce    b. widen    c. require    d. acquire

**6-All students should ----- that English language is very important.**

- a. realize     b. test    c. work    d. go

**7-The word “honest or responsible ” is closest in meaning to the word -----**

- a. criminal    b. upright     c. lazy    d. clever

**8- The phrase “ a metal piece of money ” is closest in meaning to the word -----**

- a. coin     b. banknote    c. paper    d. invoice

### ❖ Parts of speech

Every Simple sentence must contains at least two or some or all of the following parts speech:

1. **An article** { a – an – the }
2. **A noun** ( singular/ plural = { subject noun / object noun }
3. **A pronoun** { I , he, She, their, us, me.....etc }

4. **An adjective** { easy, hot, important, high, ----- smaller, best .....etc}
5. **An adverb** { quickly, easily, fast, fluently, well .....etc}
- A main verb** { present, past, future{ ,
6. **An auxiliary** { verbs to Be, verbs to Have, Modals }
7. **A preposition** { on, in, at, by, with, for .....etc

### Exercise

Circle the most suitable answer a, b, c or d for each of the following .  
The final test will be similar to the questions in the lectures exercises.

**1. The part speech of “ final” is -----**

- A. a verb            B. an adverb            C. a noun            D. an adjective

**2. The part speech of “ questions ” is -----**

- A. a verb            B. an adverb            C. a noun             D. an adjective

**3 . The part speech of “ will” is -----**

- A. a main verb            B. a verb to be            C. a modal             D. a preposition

**4. The part speech of “ in” is -----**

- A. a verb            B. a preposition             C. a noun D. an adjective

week. Last the first homework us gave doctor The

**5. The part speech of “ us” is ----- pronoun**

- A. a possessive            B. an object             C. a subject            D. a reflexive

**6. The part speech of “ gave ” is -----**

- A. a present verb            B. an auxiliary            C. a future verb            D. a past verb

**7. The part speech of “ last” is -----**

- A. an adjective             B. a verb to be            C. an article            D. a preposition

**8. The part speech of “ doctor” is -----**

- A. a verb            B. a subject noun             C. an object noun D. an adjective

### Fashion: The Art of the Body

A The enormous and fascinating variety of clothing may express a person’s status or social position. Several hundred years ago in Europe. Japan, and China, there were many highly detailed sumptuary laws—that is, strict regulations concerning how each social class could dress. In Europe, for example, only royal 5 families could wear fur, purple silk, or gold cloth. In Japan, a farmer could breed silkworms· but he couldn’t wear silk. In many societies, a lack of 10 clothing indicated an absence of status. In ancient Egypt, for instance, children—who had no social status—wore no clothes until they were about twelve. 15 These days, in most societies (especially in the West), rank or status is exhibited through regulation of dress only in the military, where the appearance or absence of certain metal buttons or stars signifies the dividing line between ranks. 20 With the exception of the military; the divisions between different of society are becoming less clear. The clientele of a Paris café, for example, might include both working-class people and members of the highest society, but how can one tell the difference when everyone is wearing denim jeans? 25



▲ A street in Paris

**1. What is the topic of Paragraph A?**

- a. the military      b. sumptuary laws      c. uniforms ✓      d. status

**2. What details about the topic does the paragraph provide? (Choose more than one answer).**

- a. Strict laws in some countries used to regulate what people of each social class could wear.  
b. Rich people wear more beautiful clothing than poor people do.  
c. In many societies, the absence of clothing indicated an absence of status.  
d. Today, the divisions between social classes are becoming less clear from the clothing that people wear. ✓

**3. What do the answers to numbers 1 and 2 have in common? That is, what is the main idea of Paragraph A?**

- a. Today, the differences between various social classes can be seen only in military uniforms.  
b. Laws used to regulate how people could dress.  
c. Clothing (or its absence) has usually indicated status or rank, but this is less true in today's world ✓  
d. Clothing has been worn for different reasons since the beginning of history.

**B** Three common types of body decoration are *mehndi* or *henna*, tattooing, and scarification.

*Mehndi* or *henna* is the art of applying dye (usually dark orange or dark brown) to the skin of women in India, Islamic cultures, and Africa. The dye comes from the henna plant and is applied in a beautiful design that varies from culture to culture—fine, thin lines in India and large flower patterns in the Arab world, for example. (See page 101 for a photo of a *mehndi* or henna design.) A tattoo is also a design or mark made with a kind of dye (usually dark blue); however, unlike henna, it is put into a cut in the skin. In scarification—found mainly in Africa—dirt or ashes are put into the cuts instead of dye; the result is a design that is unique to the person's tribe. Three lines on each side of a man's face identify him as a member of the Yoruba tribe of Nigeria, for example. A complex geometric design on a woman's back identifies her as Nuba (from Sudan) and also makes her more beautiful in the eyes of her people. In the 1990s, tattooing became popular among youth in urban Western societies. Unlike people in tribal cultures, these young people had no tradition of tattooing; except among sailors and criminals. To these young people, the tattoos were beautiful and were sometimes also a sign of rebellion against older, more conservative people in the culture. These days, tattooing has become common and is usually not symbolic of rebellion.

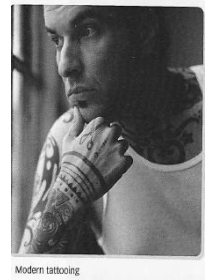
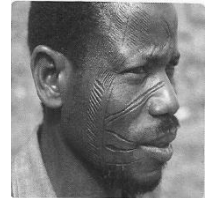

**1. What is the topic of Paragraph B?**

- a. the Yoruba people      b. geometric designs      c. dirt and ashes      d. body decoration ✓

**2. What details about the topic does the paragraph provide? (Choose more than one answer.)**

- a. Mehndi or henna, tattooing, and scarification are types of body decoration. ✓  
b. Tattoos and scarification indicate a person's tribe or social group, although youth in Western societies sometimes use tattoos as a form of rebellion. ✓  
c. Scarification is very painful and is symbolic of strength.  
D. Designs on a person's face or body are considered beautiful.

**3. Which idea below includes all the details that you chose in number 2? In other words, what is the main idea of the paragraph?**

- a. Everyone who wants to be beautiful should get a tattoo.  
b. People decorate their bodies for the purposes of identification, beauty, and sometime srebellion ✓  
c. Mehndi or henna and tattoos are designs made by putting dye on or in the skin.  
d. Men more often decorate their faces; women often decorate their backs.



In some societies, women overeat to become plump because large women are considered beautiful, while skinny women are regarded as unattractive. A woman's plumpness is also an indication of her family's wealth. In other societies, by contrast, a fat person is considered unattractive, so men and women eat little and try to remain slim. In many 60 parts of the world, people lie in the sun for hours to darken their skin, while in other places light, soft skin is seen as attractive. People with gray hair often dye it black, whereas those with naturally dark hair often change its color to blond or green or purple.

**1. What is the topic of Paragraph C?**

- a. hair      b. skin      c. body shape      d. body changes ✓

**2. What details about the topic does the paragraph provide? (Choose more than one answer.)**

- a. It is unhealthy to lose or gain too much weight.  
b. Some societies consider large people attractive; others, slim ones. ✓  
c. Some people prefer dark hair or skin; others, light. ✓  
d. Most wealthy people try to stay thin.

**3. What is the main idea of Paragraph C?**

- a. Individuals and groups of people have different ideas about physical attractiveness. ✓  
b. Lying in the sun darkens the skin.  
c. In some societies, thinness is an indication that a family is poor.  
d. Dark-skinned people usually have dark hair.

D      In the West, most people visit a dentist regularly for both hygiene and beauty. They use toothpaste and dental floss daily to keep their teeth clean. They have their teeth straightened, whitened, and crowned to make them more attractive to others in their culture. However, "attractive" has quite a different meaning in other cultures. In the past, in Japan, it was the custom for women to blacken, not whiten, the teeth. People in some areas of Africa and central Australia have the custom of filing the teeth to sharp points. And among the Makololo people of Malawi, the women wear a very large ring—a pelele—in their upper lip. As their chief once explained about peleles: "They are the only beautiful things women have. Men have beards. Women have none. What kind of person would she be without the pelele? 75 She would not be a woman at all." While some people in modern urban societies think of tribal lip rings as unattractive and even "disgusting," other people—in Tokyo or New York or Rome—might choose to wear a small lip ring or to pierce their tongue and wear a ring through the hole.

**1. What is the topic of Paragraph D?**

- a. dentistry  
b. blackening or whitening the teeth ✓  
c. changes to the human mouth  
d. peleles and beards

**2. What details about the topic does the paragraph provide? (Choose more than one answer.)**

- a. White teeth are attractive to all cultures.  
b. In the West, people visit dentists and have their teeth straightened, whitened, and crowned. ✓  
c. In some cultures, people blacken their teeth or file them to sharp points, and in other cultures young people wear lip rings or tongue rings. ✓  
d. Makololo women wear a large ring in their upper lip.

### 3. What is the main idea of Paragraph D?

- a. People can easily change the color or shape of their teeth.
- b. What is attractive has different interpretations.
- c. The human mouth suffers change and abuse in many societies. ✓
- d. Some methods of changing the appearance of the mouth are dangerous, but others are safe.

**E** Body paint or face paint is used mostly by men in preliterate societies in order to attract good health or to ward off disease. Anthropologists explain that it is a form of magic protection against the dangers of the world outside the village, where men have to go for the hunt or for war. When it is used as warpaint, it also serves to frighten the enemy, distinguish members of one's own group from the enemy, and give the men a sense of identity of belonging to the group. Women in these societies have less need of body or face paint because they usually stay in the safety of the village. Women in Victorian society in England and the United States were expected to wear little or no makeup. They were excluded from public life and therefore didn't need protection from the outside world. In modern societies, however, cosmetics are used mostly by women, who often feel naked, unclothed, without makeup when out in public—like a tribal hunter without his warpaint. 100



Papua New Guinean man wearing tribal face paint



Woman wearing modern "face paint"

### 1. What is the topic of Paragraph E?

- a. body and face paint ✓
- b. men's warpaint
- c. modern women's cosmetics
- d. magic protection

### 2. What details about the topic does the Paragraph provide? (Choose more than one answer.)

- a. Body or face paint is usually worn by men in tribal societies. ✓
- b. People wear body or face paint to make them more attractive. ✓
- c. Makeup ("face paint") is usually worn by women in modern societies.
- d. When women are excluded from public life, they wear little or no makeup. ✓

### 3. What is the main idea of Paragraph E?

- a. Body paint gives men a sense of identity.
- b. Women in modern times wear makeup to be more beautiful.
- c. In the past, men wore face paint, but in modern times, women wear it.
- d. Body or face paint may be worn as a sort of protection by people who leave the home or village. ✓

### Scanning & skimming A reading passage page 183

In some societies, women overeat to become plump because large women are considered beautiful, while skinny women are regarded as unattractive. A woman's plumpness is also an indication of her family's wealth. In other societies, by contrast, a fat person is considered unattractive, so men and women eat little and try to remain slim. In many parts of the world, people lie in the sun for hours to darkens **their** skin, while in other places light, soft skin is seen as attractive. People with gray hair often dye **it** black, whereas those with naturally dark hair often change its color to blond or purple.

**Now answer the questions that follow.**

**Questions**

Choose the most appropriate answer

**1. The most appropriate topic for the paragraph is -----**

- A. Skin Change
- B. Hair Color
- C. Different views about body shape     ✓
- D. Family's Wealth

**2. The best Main Idea of the paragraph is that -----**

- A. people with gray hair often dye it with black
- B. people lie in the sun to darken their skin
- C. women's plumpness is also an indication of wealth
- D. people have different attitudes about their bodies     ✓

**3. Why do men and women eat little in some in some societies ? -----**

- A. To remain slim     ✓
- B. To become plump
- C. Because they are poor
- D. To save much money

**4. The underlined pronoun " their " line 5 refers -----**

- A. people     ✓
- B. women
- C. men
- D. fat persons

**5. The word in the paragraph that is closest in meaning to the word " thin" is -----**

- A. plump
- B. skinny     ✓
- C. blond
- D. attractive

**6. The underlined pronoun " it " line 6 refers -----**

- A. skin
- B. body
- C. gray hair     ✓
- D. color

## Lecture 11

### Scanning & Skimming a reading text ( pages 202)

We all know the expression to change your mind. But is it possible literally to change your mind-or, to be more **precise**, to change your brain? Reports from 2005 says yes. First, the bad news, at least for smokers: a study from the University of Edinburgh, in Scotland. **It** concludes that smoking makes people less **intelligent**. On cognitive tests ( tests that involve judgment), smokers did significantly worse than nonsmokers. The theory that toxins- poisons- in the smoke enter the blood and damage blood vessels providing the brain with oxygen. And there is more bad news, for most of us: a study from the University of London says that " informania"- the constant flood of information from cell phones, emails, and text messaging- can reduce intelligence by ten points on an IQ test.

#### **1. Where are the universities of Aberdeen and Edinburg located?**

- A. in London      B. in Scotland       C. in the USA      D. in Liverpool

#### **2. The underlined word " precise " line 2 means -----**

- A. clear       B. different      C. normal      D. ambiguous

#### **3. ----- is the cause of being less intelligent.**

- A. Sleeping      B. Nonsmoking      C. Smoking       D. Studying

#### **4. The test that involves judgment is called a/an ----- test.**

- A. Ability      B. Toxins      C. Cognitive       D. Vessel

#### **5. The underlined pronoun " it" Line 4 refers to -----**

- A. the university      B. Scotland      C. a study       D. Edinburg

#### **6. The underlined word " intelligent " line 2 means -----**

- A. interesting      B. different      C. famous      D. clever

#### **7. What is the function of blood vessels ? -----**

- A. providing brain with blood      B. thinking      C. providing brain with oxygen       D. moving

#### **8. The word in the paragraph which is closest in meaning to the word" poison" -----**

- A. tests      B. toxins       C. reports      D. smokers

#### **9. The constant flood of information from cell phones and emails is called -----**

- A. informania       B. toxin      C. intelligence      D. blood vessels

#### **10. The most appropriate TOPIC of the paragraph is -----**

- A. providing brain with blood      B. Smoking      C. providing brain with oxygen      D. Changing your mind

### Vocabulary Previewing ( pages 171/ 200 )

No.	New words	meanings
1	Vast ( adj )	Big and wide
2	Depict ( V )	Show in the form of a picture
3	Merchant ( N )	tradesman
4	Sum up ( PV )	conclude
5	Point out ( VP )	Indicate
6	Handsome ( Adj )	Looks beautiful and attractive
7	Route ( N )	way or road street
8	Region ( N )	area / district
9	Found ( V )	establish
10	Mature ( adj )	Fully grown

## Exercise

1. Our doctor always ----- the importance of the contents of lectures in the final test.

- A. fixes                      B. points out ✓                      C. looks                      D. takes

2. King Faisal University was ----- in 1975.

- A. found                      B. founded ✓                      C. bought                      D. pointed out

3. The word "-----" is closest in meaning to the word tradesman.

- A. merchant ✓                      B. policeman                      C. district                      D. mature

4. The phrase "fully grown" is closest in meaning to the word "-----"

- A. beautiful                      B. ugly                      C. mature ✓                      D. important

## ❖ COUNTABLE AND UNCOUNTABLE NOUNS

Countable nouns can be singular or plural:

1. My **dog** is playing.
2. My **dogs** are hungry.
3. I have got **one egg**.
4. I have got **two eggs**.

• **We can use the indefinite article a/an with countable nouns:**

1. A dog is **an** animal.
2. I'm waiting for **a** bus.

• **When a countable noun is singular, we must use a word like a/the/my/this with it:**

1. I want **an** orange. (not I want orange).
2. Where is **my** bottle? (not Where is bottle)?

• **When a countable noun is plural, we can use it alone:**

1. I like oranges.
2. Bottles can break.

• **We can use some and any with countable and uncountable nouns:**

1. **Some** is used in..... I've got **some** dollars.
2. **Any** is used in..... Have you got **any** pens?
3. **Some** people arrived.
4. I bought **some** milk.
5. Did you meet **any** friends in the city?
6. I didn't have **any** water.

Practice Complete the sentences with a, an, some or any.

1. Would you like   a   cup of coffee?
2. There is   some   Butter in the fridge.
3. Can I make   a   telephone call?
4. There weren't   any   in the house.
- 5.

• **We can use a few and many with plural countable nouns:**

1. I've got a **few** dollars.
2. I've got a **few** friends.
3. I haven't got **many** pens.
4. They haven't got **many** friends

- **We can use a little and much with uncountable nouns:**

1. I've got a **little** money.
2. I haven't got **much** rice.
3. I've got a **little** milk.
4. We haven't got **much** time

- **Write a few, a little, much or many to complete these sentences. Don't use some, any or a lot of.**

1. There's some food but not much drink.
2. a few people arrived before the party started, but not many.
3. There's not much coffee in the cup.
4. She hasn't got many friends.
5. I'm sorry, I haven't got much Time.
6. The receptionist didn't give me much Information.

- **A lot of – some / any – Much / Many – A few / A little Underline the correct item.**

1. Are you hungry? There is a little / a few roast beef left.
2. I can't make a cake. We haven't got **much** / any eggs.
3. There is a **few** / a lot of sugar in the cupboard. we don't need to buy any.
4. Can I have some / **much** milk for my coffee?
5. We need a few / **much** more peppers to make the dish.
6. We've got a lot of / **a little** bananas so you don't have to buy any.
7. There isn't **many** / much food left. We'll have to go shopping.
8. This restaurant offers a few / **a little** vegetarian dishes.

- **"People" is countable. "People" is the plural of "person". We can count people:**

1. There is one person here.
2. There are three people here.

### ❖ **Uncountable Nouns**

Unlike Countable nouns, which can be counted, Uncountable nouns are substances, concepts etc that we cannot divide into separate elements. We cannot "count" them. For example, we cannot count "milk". We can count "bottles of milk" or "litres of milk", but we cannot count "milk" itself.

- **Here are some more uncountable nouns:**

music, art, love, happiness, advice, information, news, furniture, luggage, rice, sugar, butter, water, electricity, gas, power, money, currency

- **We usually treat uncountable nouns as singular. We use a singular verb. For example:**

1. **This** news is very important.
2. Your luggage **looks** heavy.

- **We do not usually use the indefinite article a/an with uncountable nouns. We cannot say "an information" or "a music". But we can say a something of:**

1. **a piece of** news
2. **a bottle of** water
3. **a grain of** rice

- **We can use some and any with uncountable nouns:**

1. I've got **some** money.
2. Have you got **any** rice?

<b>Countable</b>	dollar	song	suitcase	journey	battery	tip	bottle	table	job	view	report
<b>Uncountable</b>	money	music	luggage	furniture	electricity	wine	information	work	advice	travel	scenery

• **Nouns that can be Countable and Uncountable**

Sometimes, the same noun can be countable and uncountable, often with a change of meaning.

<b>Countable</b>		<b>Uncountable</b>
There are two hairs in my coffee!	hair	I don't have much hair.
There are two lights in our bedroom.	light	Close the curtain. There's too much light!
Shhhhh! I thought I heard a noise.	noise	It's difficult to work when there is too much noise.
Have you got a paper to read? (= newspaper)	paper	I want to draw a picture. Have you got some paper?
Our house has seven rooms.	room	Is there room for me to sit here?
We had a great time at the party.	time	Have you got time for a coffee?
Macbeth is one of Shakespeare's greatest works.	work	I have no money. I need work!

**Drinks (coffee, water, orange juice) are usually uncountable. But if we are thinking of a cup or a glass, we can say (in a restaurant, for example):**

Two teas and one coffee please.

**HOW MANY OR HOW MUCH**

1. How many books are there on the desk?
2. How much water is there in the glass?
3. How many computers are there in the laboratory?
4. How many mistakes are there in your exam?
5. How much sugar is there on the floor?
6. How many triangles did you bring?
7. How many bones do we have?
8. How many students are there in the classroom?
9. How many credit cards do you have?
10. How much money did you ask?

**Exercises**

**UNDERLINE THE CORRECT WORD IN EACH SENTENCE**

1. Are there **a / any** people at the bus station?
2. Look at this shirt!. Can I borrow **an / some** iron?
3. Did you buy **a / some** magazine?
4. Could you buy **a / some** bread at the market?
5. There aren't **any / some** payphones near here
6. She brings **some / any** balls to play

**PLACE ANY OR SOME IN THE FOLLOWING SENTENCESU**

1. There isn't.....*any*.....money
2. There aren't.....*any*.....new clothes.
3. There are.....*some*..... pencils.
4. There aren't.....*any*.....more apples.
5. There is .....*some*..... milk on the table.
6. There aren't.....*any*.....curtains.
7. There are.....*some*..... other options.

**To Sum Up:**

**Using ( many/much/ a few/ a little, some, several...etc) page 195**

- A. **Many, a few , few, some, several** = Used before countable nouns  
**Countable nouns** ( nouns that can be singular and plural)  
e.g [ boy- car – door – page – girl – houses.....etc]
- B. **Much, a little, little, some**= Used before uncountable nouns  
**Uncountable nouns** ( nouns that don't have singular or plural forms)  
e.g [ water – sugar – snow – money – food – milk, .....etc]
- C. **A, An , Each & Every** = used before singular nouns
- D. **Any**= used in negative and questions.
- E. **Some**= used when we offer something

**Sample Questions ( many/much/ a few/ a little, some, several...etc )**

1. I was very hungry. I ate ----- .

- a. many                      b. little                      c. much                       d. a few

2. ----- students will pass the test. It is vey easy.

- a. Few                      b. Some                      c. A few                      d. Many

3. Fortunately, ----- people died in the terrible accident.

- a. Many                      b. Some                      c. Few                      d. A few

4. He was very happy . He won ----- money in the project.

- a. many                      b. much                       c. little                      d. a few

5. ----- student should have the textbooks.

- a. many                      b Some                      c. Every                       d. All

6. I didn't like the food. I ate -----

- a. much                      b. many                      c. little                       d. few



## Lecture 12 Comparatives & Superlatives

### ❖ Contents

#### • **Introduction**

- What is a noun?
- What is an adjective?
- What is a syllable?
  - Syllable – further examples

#### • **Adjectives**

- Comparative form
  - How to built comparative forms?
- Superlative form
  - How to built superlative forms?

#### • **Summary**

- Comparison chart

### What is a noun?

Noun is a word which refers to a thing, person, activity, place etc.



car



reading



street



Teacher

### What is an adjective?

Adjective is a word which describes a noun

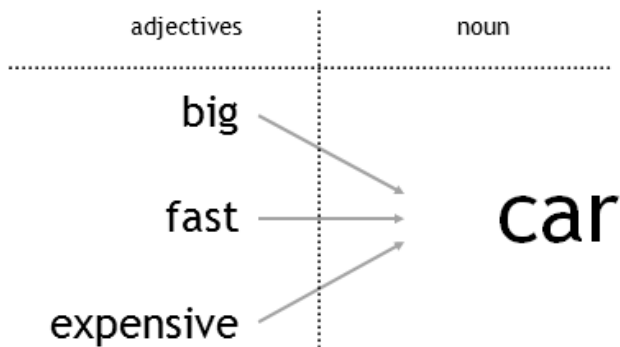

### What is a syllable?

Syllable is a part of a word containing vowel sound

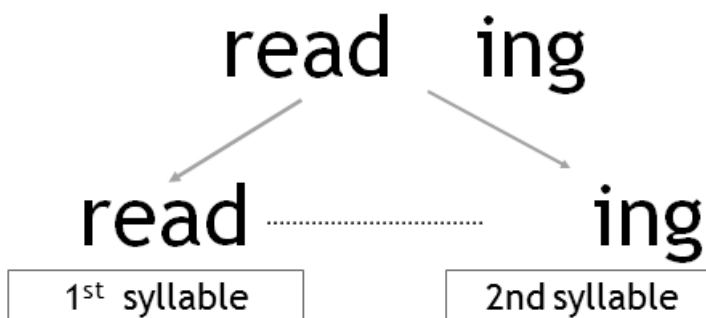

## Syllables – examples

### 1. One-syllable adjectives

—————> fast big cheap long

### 2. Two-syllable adjectives

—————> Hap py car zy dir ty

### 3. Three-syllable adjectives

—————> Im por tant won der full

## LET'S START ☺

Adjectives and adverbs are words that modify other words. The comparative form of an adjective or adverb compares two things. The superlative form of an adjective or adverb compares three or more things.

## What is a “comparative form”?

Comparative form expresses the idea of ‘more’

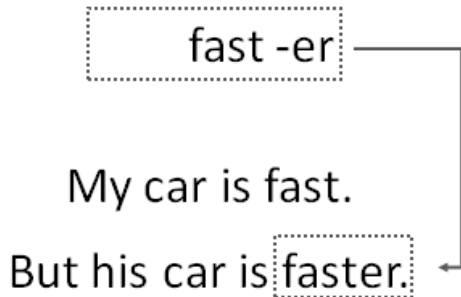

## “Comparative form”?

How is a ‘comparative’ form built?

one syllable adjectives

two syllable adjectives ending in -ly

other two and three syllable adjectives

irregular adjectives for example ‘good

**long er**

**funny ier**

**more modern**

**better**

## Change of ‘y’ into ‘i’

We want the comparative form of the adjective ‘funny’

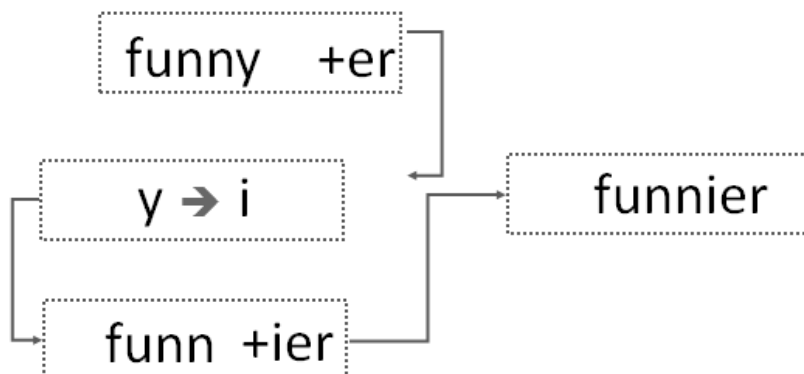

## What is a “superlative form”?

Comparative form expresses the idea of ‘most’

fast -est

My car is fast.

Your car is fast.

But his car is the **fastest**.

## “Superlative form”?

How is a ‘superlative’ form built?

one syllable adjectives

**long est**

two syllable adjectives ending in -ly

**funny iest**

other two and three syllable adjectives

**most modern**

irregular adjectives for example ‘good’

**best**

## Summary comparison

	<b>comparative</b>	<b>superlative</b>
<b>long</b>	long er	long est
<b>funny</b>	Funny er	Funny iest
<b>modern</b>	More modern	Most modern
<b>good</b>	Better	Best

To make comparative and superlative forms of adjectives some rules must be followed.

### ▪ Rule 1

To form the comparative or superlative of one syllable words with more than one vowel OR ending with more than one consonant at the add -er OR -est.

tall	taller	tallest
neat	neater	neatest
deep	deeper	deepest

### ▪ Rule 2

To form the comparative or superlative of a one syllable word ending in e add -r OR -st.

wide	wider	widest
fine	finer	finest
cute	cuter	cutest

▪ **Rule 3**

To form the comparative or superlative of a one syllable word with one vowel and one consonant at the end double the consonant, and add -er OR -est.

sad	sadder	saddest
big	bigger	biggest
fat	fatter	fattest

▪ **Rule 4**

To form the comparative or superlative of a two syllable word ending in y, change the y to i, then add -er OR -est.

happy	happier	happiest
jolly	jollier	jolliest
lazy	lazier	laziest

▪ **Rule 5**

To form the comparative or superlative of a two syllable word ending a vowel-sound that is not stressed then add -er OR -est. Adjectives ending in -le, -ow, er frequently take -er and -est.

yellow	yellower	yellowest
gentle	gentler	gentlest
simple	simpler	simplest

❖ **Rules at a Glance**

Adjective form	Comparative	Superlative
Only one syllable, with more than one vowel or more than one consonant at the end. Examples: <i>light, neat, fast, tall, neat, deep</i>	Add -er: <i>lighter, neater, faster, taller, neater, deeper</i>	Add -est: <i>lightest, neatest, fastest, tallest, neatest, deepest</i>
Only one syllable, ending in E. Examples: <i>wide, fine, cute</i>	Add -r: <i>wider, finer, cuter</i>	Add -st: <i>widest, finest, cutest</i>
Only one syllable, with one vowel and one consonant at the end. Examples: <i>hot, big, fat, sad</i>	Double the consonant, and add -er: <i>hotter, bigger, fatter, sadder</i>	Double the consonant, and add -est: <i>hottest, biggest, fattest, saddest</i>
Two syllables, ending in Y. Examples: <i>happy, silly, lonely, jolly</i>	Change y to i, then add -er: <i>happier, sillier, lonelier, jollier</i>	Change y to i, then add -est: <i>happiest, silliest, loneliest, jolliest</i>
two syllable word ending a vowel-sound that is not stressed <i>yellow, simple</i>	Add -er: <i>yellower, simpler</i>	Add -est: <i>yellower, simpler</i>
Two syllables or more, not ending in Y. Examples: <i>modern, interesting, beautiful,</i>	Use more before the adjective: <i>more modern, more interesting, more beautiful</i>	Use most before the adjective: <i>most modern, most interesting, most beautiful</i>

**NOTE:**

Like adjectives some adverbs can take comparative and superlative forms, with -er and -est:



Sally works hard.

Steve works harder than Sally

Kathy and Sue work the hardest of all.



The bird sings loudly.

The moose sang louder than the bird.

Pete sang the loudest of them all.

**List of Adverbs in Which -er and -est May Be Added**

Adverb	Comparative	Superlative
fast	faster	fastest
slow	slower	slowest
quick	quicker	quickest
early	earlier	earliest
bright	brighter	brightest
high	higher	highest

However, the majority of adverbs do not take these endings. Instead, they form the comparative using more and the superlative using most:

Adverb	Comparative	Superlative
recently	more recently	most recently
effectively	more effectively	most effectively
frequently	more frequently	most frequently

**Irregular Comparative and Superlative Adjectives and Adverbs**

Some comparative and superlative forms are irregular and do not follow any rules or patterns. These must be memorized.

**USE OF COMPARATIVES**

Comparatives are very commonly followed by **than** and a pronoun or noun group, in order to describe who the other person or thing involved in the comparison is, **e.g.:**

John is taller than me.

I think that she's more intelligent than her sister.

❖ **OTHER USES OF COMPARATIVES**

- **Comparatives are often qualified by using words and phrases such as much, a lot, far, a bit/little, slightly etc., e.g.:**  
 You should go by train, it would be much cheaper.  
 Could you be a bit quieter?  
 I'm feeling a lot better.  
 Do you have one that's slightly bigger?
- **Two comparatives can be contrasted by placing *the* before them, indicating that a change in one quality is linked to a change in another, e.g.:**  
 The smaller the gift, the easier it is to send.  
 The more stressed you are, the worse it is for your health.
- **Two comparatives can also be linked with *and* to show a continuing increase in a particular quality, e.g.:**
  - The sea was getting rougher and rougher.
  - Her illness was becoming worse and worse.
  - He became more and more tired as the weeks went by

❖ **USE OF SUPERLATIVES**

As shown in the second two examples, superlatives are often used on their own if it is clear what or who is being compared. If you want to be specific about what you are comparing, you can do this with a noun, or a phrase beginning with *in* or *of*, e.g.:

- ☺ Annabel was the youngest child
- ☺ Annabel was the youngest of the children
- ☺ This restaurant is the best in town.

❖ **THE OPPOSITES OF COMPARATIVE AND SUPERLATIVES**

We use the forms **less** (the opposite of comparative *more*), and **the least** (the opposite of superlative *the most*).

**Less** is used to indicate that something or someone does not have as much of a particular quality as someone or something else, e.g.:

- ☺ This sofa is less comfortable.
- ☺ I've always been less patient than my sister.

**The least** is used to indicate that something or someone has less of a quality than any other person or thing of its kind, e.g.:

- ☺ It's the least expensive way to travel.
- ☺ She was the least intelligent of the three sisters.

❖ **Irregular Adverbs**

Word	Comparative	Superlative
badly	worse	worst
much	more	most
little	less	least
much	more	most
well	better	best

❖ **Irregular Adjectives**

Word	Comparative	Superlative
good	better	best
bad	worse	worst
much	more	most
little	less	least
far	farther	farthest
old	older elder	oldest eldest

**Example:**

- ☺ Nathan made **good** stew.
- ☺ Molly's stew was **better** than Nathan's.
- ☺ Ezra made the **best** stew of all.

**Let's Start Exercising U**

1. The weather in winter is \_\_\_\_\_ than it is in summer.

- A. colder ✓ B. cold C. coldest D. the coldest

2. I have \_\_\_\_\_ money than you do.

- A. much B. more ✓ C. most D. least

3. Abdullah is \_\_\_\_\_ of all boys.

- A. the fastest ✓ B. the most fastest C. fast D. faster

**Do More Exercises**

1. What is the comparative of "sad"?

- A. sader B. sadder ✓ C. sadier D. saddier

2. What is the comparative of "destructive"?

- A. destructiver B. more destructive ✓ C. destructivier D. more destructiver

3. What is the superlative of "soft"?

- A. softest ✓ B. softiest C. softtest D. most soft

4. What is the comparative of "hot"?

- A. hoter B. hotter ✓ C. hotest D. hottest

5. What is the comparative of "heat"?

- A. heater B. heatter C. heatier D. hetter E. none of these ✓

6. What is the superlative of "ugly"?

- A. uglier B. ugliest C. uglyest D. ugliest ✓

7. What is the superlative of "unpleasant"?

- A. unpleasant B. most unpleasant ✓ C. more unpleasant D. unpleasantest

10. To fall from a motorcycle is \_\_\_\_\_ to fall from a bicycle.

- A. more painful B. more painful than ✓ C. painfuller than D. the painfulest

11. If you suffer asthma, don't go to Mexico City. It is one of the \_\_\_\_\_ cities in the world

- A. pollutest B. more polluted C. polluter than D. most polluted ✓

12. The \_\_\_\_\_ place from Chile is Australia. It's on the other side of the world.

- A. farther      B. farthest ✓      C. farther than      D. farthest than

13. I don't think your bike is \_\_\_\_\_ mine.

- A. fastest than ✓      B. faster      C. fastest      D. faster than

14. Michael was \_\_\_\_\_ basketball player in the world

- A. taller      B. tallest      C. the taller      D. the tallest ✓

15. Speaking Japanese is \_\_\_\_\_ writing it.

- A. the easiest      B. easy      C. easier than ✓      D. easier than

Write the following sentences using the correct form of the adjective (**comparative or superlative**)

- Clare is older than Mike. (old)
- Jane is the healthiest of the four. She eats very well and does a lot of sports, (healthy)
- The coach thinks that Peter is the fastest player of the team, (fast)
- The Sahara desert is one of the hottest deserts in the world. (hot)
- The climate in the North of Chile is drier than it is in the South, (dry)
- Asia is bigger than Europe. (big)
- A Rolls-Royce is one of the most expensive cars in the world. (expensive)
- The most violent hurricanes are developed over México, (violent)
- Diamonds are the most precious jewels in the world. (precious)
- History classes are more interesting chemistry classes. (interesting)





Adverb	describes a verb, adjective or adverb	The hungry dog intently watched the grey squirrel.
Pronoun	replaces a noun	<b>He</b> ate dinner.
Preposition	links a noun to another word	I gave a bone <b>to</b> the dog.
Conjunction	joins clauses or words	Peter read the paper <b>and</b> listened to the radio <b>while</b> he ate dinner.

❖ What Makes a Sentence?

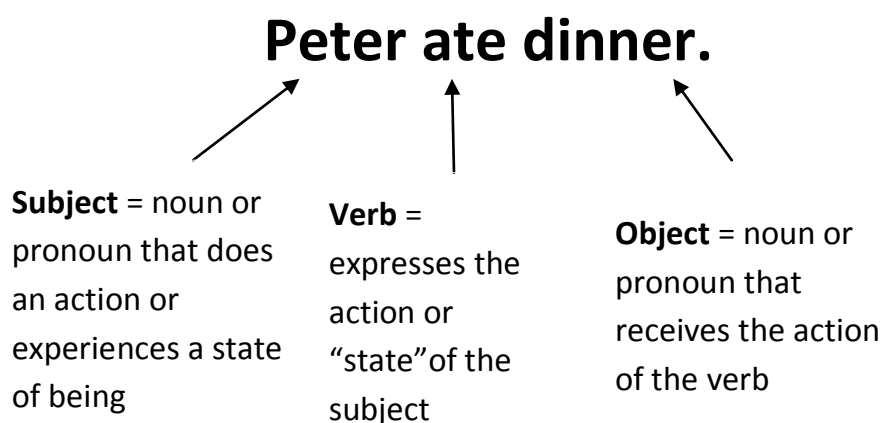

This is also a sentence ...

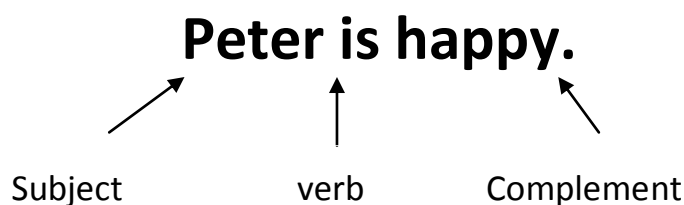

A **complement** is a great deal like an object, but it differs in that it does **not "receive" the action a verb. Instead it "is" the subject.**

Complements can be nouns or adjectives. The key to understanding them is understanding the verbs that they follow.

❖ Verbs that take complements ...

(thank you very much!)

**Intensive Verbs** such as *be* and *feel* do not have action moving "out" of them to affect a noun. Instead they hold action "within" them.

Look at the images above the verbs in the following sentences:

**Peter *threw* the bone.          Peter *is* happy.**

- ☺ The verb **threw** is NOT an intensive verb (the action moves out of it to affect the object).
- ☺ The verb **is** IS an intensive verb: *Peter* and *happy* are the same thing, so the mathematical equal sign better represents the "action" of this intensive verb.

### ❖ Common Intensive English Verbs

be  
feel  
seem  
became

Remember that these verbs can be followed by nouns or adjectives. Either way, the words that follow intensive verbs “are” the subjects before the verb ... that is how you can identify a complement.

#### EXAMPLE:

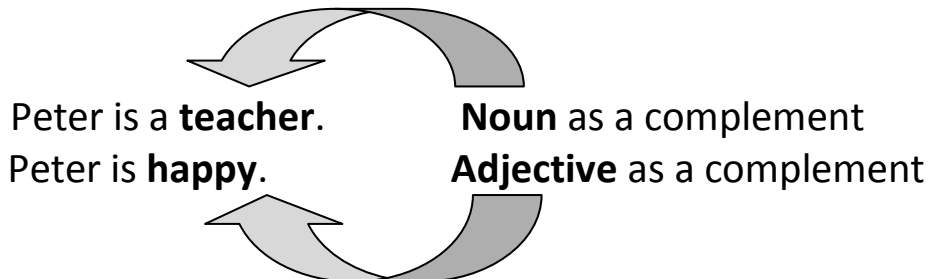

#### And this is also a sentence

**Peter was in the kitchen.**

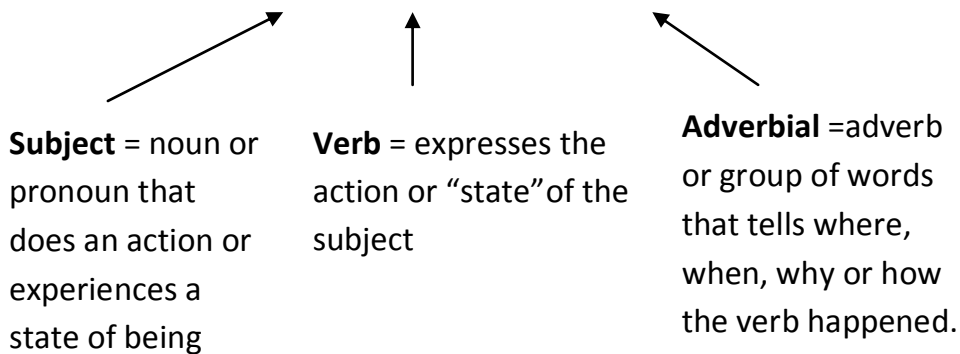

#### More Adverbial Examples

Peter was a student **last year**. ( When )  
Peter went **to New York to visit his aunt**. ( Where ) ( Why )  
Peter drive **quickly**. ( How )

#### Sentence Components

**S + V / O**  
**or C**  
**or A**

#### **Where:**

**S** = subject (a noun or pronoun that *does* an action)  
**V** = verb (the action itself)  
**/** = “optional” → some verbs do not need an O, C or A  
**O** = object (a noun or pronoun that *receives* an action)  
**C** = complement (an adjective or noun that *is* the subject)  
**A** = adverbial (an adverbial that tells more about the action)

### But here's a new question, is this a sentence?

Peter ate dinner while he watched TV.

**Yes, this is a sentence.** It is the sentence from an earlier slide (Peter ate dinner) with additional information added ... now we know that Peter was doing two things at once, eating dinner and watching TV.

Let's take a look at the components of this new sentence

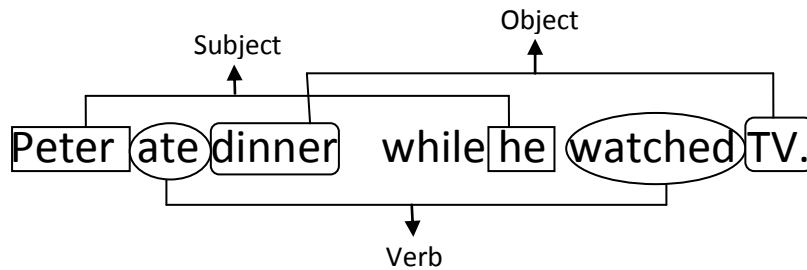

We have the original subject **Peter** with its verb **ate** and its object **dinner**.

But the sentence continues with a second subject, this time **he**, a second verb, **watched**, and a second object, **TV**.

### Clause

Our one sentence is basically two "mini" sentences hooked together by the word **while**.

**Peter ate dinner while he watched TV.**

"Mini" sentences, **units of SV/O,C or A**, within a sentence are called **clauses**.

**Peter ate dinner**    **while he watched TV.**



This sentence is composed of two clauses.

But we can still add more to this sentence.

**{ After exercising, } Peter ate dinner while he watched TV.**

In addition to the two clauses we are familiar with, this sentence has the added words **after exercising**.

The words **after exercising** work together to give extra information about the clauses, but they do not form a clause. They form a **phrase**.

### Phrase :

One way to define a phrase is to say it is a group of words that "belong together" in terms of meaning but **do not have** both a **subject** and a **verb**.

**Phrase ≠ S + V**

Another way to think of a phrase is to think of how it works within a sentence. When you think of a phrase this way, you can define it as:

**Phrase** = a group of words that acts like one word

### Example :

Here is a phrase:

1. the gym at the end of the street

It **acts** like a noun → **The gym at the end of the street** is new.

↑  
It functions as the **subject** of the sentence and **subjects are nouns**.

### a phrase within a phrase:

Phrases can have phrases “in” them.

Look carefully and you will find a phrase within the phrase:

the gym at the end of the street the gym at the end of the street

This phrase within the first phrase **acts**

like an adjective → **The gym** at the end of the street is new.

↑  
This phrase gives more information about the **noun**, thus acting like an adjective

### testing to see if you have a phrase:

The second phrase, at the end of the street, can be replaced with a one word adjective such as large.

The gym at the end of the street is new.

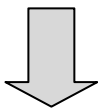

large

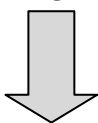

The large gym is new.

This replacement of the group of words by one word demonstrates the idea that a phrase is a group of words acting as one word.

The **one word** that a **phrase can be reduced to** lets you know its function within the sentence.

It also serves as a way to classify phrases. This part of the phrase that “holds” its function within the greater sentence is **called the head**.

In English, the head is often the first word of the phrase.

### naming phrases:

Phrases are be classified by the type of head they take:

- Prepositional phrase with a preposition as head  
(e.g. *in love, over the rainbow*)
- Noun phrase with a noun as head  
(e.g. *the black cat, a cat on the mat*)
- Verb phrase with a verb as head  
(e.g. *eat cheese, jump up and down*)
- Adjectival phrase with an adjective as head (e.g. *full of toys*)
- Adverbial phrase with adverb as head (e.g. *very carefully*)

**Putting it all together:**

Sentences are composed of clauses and phrases. Some sentences have only one clause and no phrase:

**Peter ate dinner.**

Others have two or more clauses:

**Because Peter ate dinner while he watched TV, he got indigestion.**



Other sentences have clauses and phrases.

{ **After exercising at the gym across the street**}, **Peter ate dinner** { **in the kitchen** } **while he watched TV.**

**Using Clauses and Phrases:**

- Once identifying clauses and phrases becomes easy for you, you will begin to notice how good writers put their sentence together.
- Additionally, once you become comfortable finding clauses and phrases in writing, you can begin to work with the punctuation rules for correctly and effectively putting clauses and phrases together.
- For now, simply test out your knowledge of sentences, clauses and phrases.

**Exercise:**

**What kind of phrase is each of the following words:-**

**1. Important announcement**

- a. Noun Phrase     b. Prepositional Phrase    c. Infinitive Phrase    d. Verb Phrase

**2. To speak frankly:**

- a. Noun Phrase    b. Prepositional Phrase    c. Infinitive Phrase     d. Verb Phrase

**3. Travel to a foreign country:**

- a. Noun Phrase    b. Prepositional Phrase    c. Infinitive Phrase    d. Verb Phrase

**4. Over the tree:**

- a. Noun Phrase    b. Prepositional Phrase     c. Infinitive Phrase    d. Verb Phrase

**Creating Adjective & Noun Phrases Pages 88 & 89**

No.	Word A		Word B
1	Old	<u>D</u>	A. School
2	Dream	<u>E</u>	B. Agency
3	Cell	<u>G</u>	C. Confidence
4	Technology	<u>I</u>	D. Fashioned
5	computer	<u>K</u>	E. Job
6	Career	<u>J</u>	F. Life
7	Employment	<u>B</u>	G. Phone
8	Self	<u>C</u>	H. Tuition
9	High	<u>A</u>	I. Field
10	City	<u>F</u>	J. Counseling
11	College	<u>H</u>	K. Lab

## Lecture 14

### Review

#### ❖ Getting Meaning From Context

1. Punctuation: ( ) (-) , ; :

There is a **drawback**, a disadvantage, to that idea. (Drawback means disadvantage.)

2. A clue in another Sentence: (surrounding words)

A school system in one country is not identical to the system in any other country. It cannot be exactly the same because each culture is different.

3. Logic: The educational system is a mirror that reflects the culture.

4. The words for example, for instance, such as, and among them:

**Example**: Almost four billion people will be living in cities in **developing countries** such as India and Nigeria.

5. A definition or explanation follows the connecting words that is or in other words:

Example: The downtown shopping area is now a pedestrian zone-in other words, an area for walkers only, no cars. **See Lecture 5**

#### ❖ Identifying the Main Idea

HOW TO IDENTIFY THE QUESTION	What is the topic of the passage? What is the subject of the passage? What is the main idea of the passage? What is the author's main point in the passage? With what is the author primarily concerned? Which of the following would be the best title?
WHERE TO FIND THE ANSWER	The answer to this type of question can generally be determined by looking at the first sentence of each paragraph.
HOW TO ANSWER THE QUESTION	1. Read the first line of each paragraph. 2. Look for a common theme or idea in the first lines. 3. Pass your eyes quickly over the rest of the passage to check that you have really found the topic sentence(s). 4. Eliminate any definitely wrong answers and choose the best answer from the remaining choices.

#### ❖ Understanding Pronoun Reference

Pronouns should:

1. **Agree in number**

If the pronoun takes the place of a singular noun, you have to use a singular pronoun.

If a student parks a car on campus, he or she has to buy a parking sticker.

(NOT: If a student parks a car on campus, they have to buy a parking sticker.)

2. **Agree in person**

If you are writing in the "first person" (I), don't confuse your reader by switching to the "second person" (you) or "third person" (he, she, they, it, etc.). Similarly, if you are using the "second person," don't switch to "first" or "third."

When a person comes to class, he or she should have his or her homework ready.

## ❖ Understanding Pronoun Reference

HOW TO IDENTIFY THE QUESTION	The <b>pronoun</b> “...” line X <b>refers</b> to which of the following?
	Look at the word X. Click on the word or phrase that X refers to.
WHERE TO FIND THE ANSWER	The line where the pronoun is located is given in the question. The noun that the pronoun refers to is generally found before the pronoun.
	The pronoun is highlighted in the passage. The noun that the pronoun refers to is generally found before the pronoun
HOW TO ANSWER THE QUESTION	<ol style="list-style-type: none"> <li>1. Locate the pronoun in the passage.</li> <li>2. Look before the pronoun for nouns that agree with the pronoun.</li> <li>3. Try each of the nouns in the context in place of the pronoun.</li> <li>4. Eliminate any definitely wrong answers and choose the best answer from the remaining choices.</li> </ol>

## ❖ Identifying Supporting Details

-Specific Details (facts, ideas, and examples) that support and develop the main idea.

-Let's go and read the following passage to identify the main idea, the supporting details of each idea and the conclusion.

### ❖ Understanding Italics

It's used : **1.Emphasis** Example : Overcrowding is a huge problem in that city.

### **2. A foreign word in an English sentence**

Example : In open areas in Seoul, Kaenari blooms everywhere in the spring.

### ❖ Scanning

Scanning is often confused with skimming, but is in fact a distinct reading strategy involving rapid but focused reading of text, in order to locate specific information, e.g. looking for particular details such as dates, names, or certain types of words. It is processing print at a high speed while looking for answers to specific questions. When you scan, you must begin with a specific question which has a specific answer. Scanning for information in this way should be both fast and accurate.

## ❖ Understanding Parts of Speech

W	Verb	Adjective	Adverb
Beauty, beautification	Beautify	Beautiful	Beautifully
Creation		Creative	Creatively
Crowd		Crowded	X
Difference		Different	Differently
	X	Difficult	X
Efficiency	X	Efficient	
Pollution, pollutant	Pollute		X
	Predict	Predictable	Predictably
Safety	Save		Safely
	Solve	Solvable	X
x	Worsen	worse	



- Solve** They are trying to find a solution (n.) to the problem of overcrowding, but this is a difficult problem to solve (v.).
- Pollute** Most people know about air pollution (n.) in big cities, but they're just beginning to learn about the many pollutions (n.) that we have inside buildings.
- Crowd** There are crowds (n.) of people everywhere ; the mass-transit system is especially crowded (adj.).

### ❖ Understanding Previewing Passages

Previewing is a useful way to determine the usefulness of a text, how easy or difficult it will to read, and what reading speed to use to read it well.

#### Guidelines for Previewing Passages:

"Read the title.

Look at the pictures (if there are any.)

Read the first few sentences in the first paragraph.

Read the first line of the other paragraphs.

Read the first and last sentences of the last paragraphs".

When previewing, look at tables, graphs etc as well as headings

### ❖ Understanding Common Prefixes & Suffixes page 108/ 109

**A prefix** is a syllable that is added to the **beginning** of a word to change its meaning or its part of speech.

**A suffix** is a syllable that is added to the **end** of a word to change its meaning or its part of speech.

No.	Prefix	examples	Suffix	examples
1	Dis	disadvantage	ship	friendship
2	Im	impossible	ate	irrigate
3	In	incorrect	ful	successful
4	Ir	irregular	ic	scientific
5	Un	unimportant	ion	recreation
6	En	endanger	Less	careless
7	mis	misunderstand	al	national
8	Re	rewrite	ize	apologize

**B. Now decide for each word that has a suffix what part of speech the word is (eg. noun (n), verb (v) , adverb (adv), adjective (adj) ). Insert the correct form - n, v, adv or adj into the spaces.**

programmer (for) performing a computer  
analyst organizational action  
maximize efficiency printer preferable  
printing (device) quietness microcomputer  
compiler programmable  
greatly shipment  
computerize division independence

### ❖ Recognizing Cause & Effect Page 79

Cause= is the reason Effect= is the result

**Salim didn't come to university. He was very sick.**

Effect

Cause

**:We join cause and effect in order to make one sentence by:-**

Because, as , since \_\_\_\_\_ cause or reason

As a result, there fore , consequently, so \_\_\_\_\_ effect or result

- Salim didn't come because/as/since he was very sick
- Because/Since/As Salim was sick, he didn't come.
- Salim was very sick. Therefore/ So/ As a result/ Consequently, he didn't come.

❖ **Information Questions**

No.	Wh	Situation	Example
1	Who	Person	Who is in the car? _ Reena
2	Where	Place	Where is the book? – on the table
3	When	Time	When did you arrive? – At 12 o'clock
4	Why	Reason	Why will you leave? - Because/ I feel sick
5	Whose	Owner	Whose car is that/ - its Fawaz's
6	Which	Choice	Which lecture do you prefer? – English one.
7	What	Event or thing	What did he say? – He would not come to the party
8	How	Situation and case	How is your study? – It's good
9	How often	Number of times	How often do Muslims pray a day? – Five times
10	How long	Period	How long does it take you to arrive? – 2 hours
11	How far	distance	How far is the university from your house? – 15 Kms.

❖ **Parts of speech**

Every Simple sentence must contains at least two or some or all of the following parts speech:

1. **An article** { a – an – the }
2. **A noun** ( singular/ plural = { subject noun / object noun }
3. **A pronoun** { I , he, She, their, us, me.....etc }
4. **An adjective** { easy, hot, important, high, ----- smaller, best .....etc}
5. **An adverb** { quickly, easily, fast, fluently, well .....etc}
- A main verb** { present, past, future{ ,
6. **An auxiliary** { verbs to Be, verbs to Have, Modals }
7. **A preposition** { on, in, at, by, with, for .....etc

❖ **Countable and Non-Countable**

Using ( many/much/ a few/ a little, some, several...etc) page 195

- A. **Many, a few , few, some, several** = Used before countable nouns  
**Countable nouns** ( nouns that can be singular and plural)  
 e.g [ boy- car – door – page – girl – houses.....etc]
- B. **Much, a little, little, some**= Used before uncountable nouns  
**Uncountable nouns** ( nouns that don't have singular or plural forms)  
 e.g [ water – sugar – snow – money – food – milk, .....etc]
- C. **A, An , Each & Every** = used before singular nouns
- D. **Any**= used in negative and questions.
- E. **Some**= used when we offer something

❖ **Summary comparison**

	comparative	superlative
long	long er	long est
funny	Funny er	Funny iest
modern	More modern	Most modern
good	Better	Best

### ❖ Rules at a Glance

Adjective form	Comparative	Superlative
Only one syllable, with more than one vowel or more than one consonant at the end. Examples: <i>light, neat, fast, tall, neat, deep</i>	Add -er: <i>lighter, neater, faster, taller, neater, deeper</i>	Add -est: <i>lightest, neatest, fastest, tallest, neatest, deepest</i>
Only one syllable, ending in E. Examples: <i>wide, fine, cute</i>	Add -r: <i>wider, finer, cuter</i>	Add -st: <i>widest, finest, cutest</i>
Only one syllable, with one vowel and one consonant at the end. Examples: <i>hot, big, fat, sad</i>	Double the consonant, and add -er: <i>hotter, bigger, fatter, sadder</i>	Double the consonant, and add -est: <i>hottest, biggest, fattest, saddest</i>
Two syllables, ending in Y. Examples: <i>happy, silly, lonely, jolly</i>	Change y to i, then add -er: <i>happier, sillier, lonelier, jollier</i>	Change y to i, then add -est: <i>happiest, silliest, loneliest, jolliest</i>
two syllable word ending a vowel-sound that is not stressed <i>yellow, simple</i>	Add -er: <i>yellower, simpler</i>	Add -est: <i>yellower, simpler</i>
Two syllables or more, not ending in Y. Examples: <i>modern, interesting, beautiful,</i>	Use more before the adjective: <i>more modern, more interesting, more beautiful</i>	Use most before the adjective: <i>most modern, most interesting, most beautiful</i>

### ❖ Irregular Adverbs

Word	Comparative	Superlative
badly	worse	worst
much	more	most
little	less	least
much	more	most
well	better	best

### ❖ Irregular Adjectives

Word	Comparative	Superlative
good	better	best
bad	worse	worst
much	more	most
little	less	least
far	farther	farthest
old	older elder	oldest eldest

### ❖ What's Phrase ?

A group of words that forms part of a clause. A phrase is built up on a HEADWORD, and the types of phrase are named according to the class the headword belongs to:

	HEADWORD	EXAMPLE	USES IN CLASUSES
NOUN PHRASE	noun	a large <b>jug</b> of water	Subject, object, complement
VERB PHRASE	verb	have been <b>seeing</b>	verb
PREPOSITIONAL PHRASE	preposition	<b>by</b> the roadside	Adverbial, part of a noun phrase
ADJECTIVE PHRASE	Adjective	very <b>big</b> indeed	Part of a noun phrase, complement
ADVERB PHRASE	Adverb	rather too <b>slowly</b>	Adverbial

Done 😊

I wish you all the success