

منهج رياض الأطفال



# وحداتي

يحتوي الكتاب على موضوعات  
وحدات رياض الأطفال

وحداتي  
المستوى الأول



@Arabic\_Books

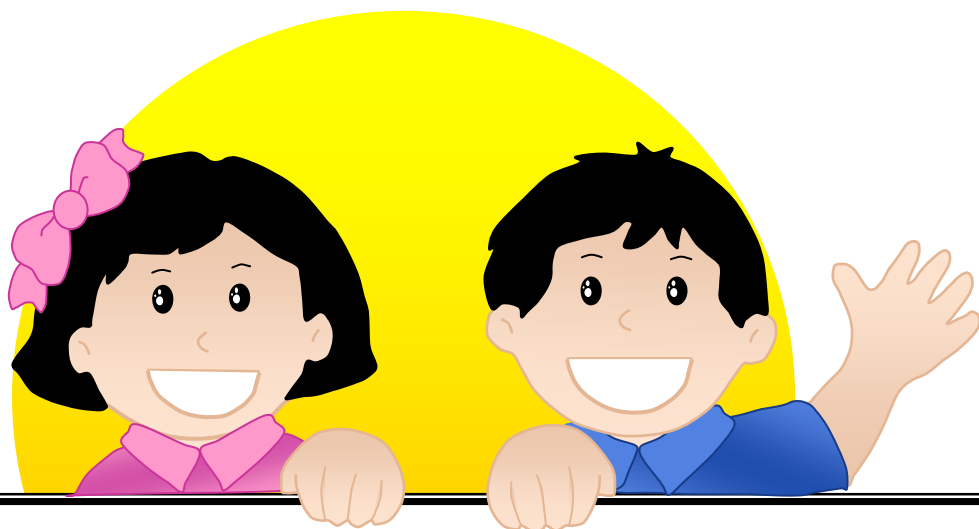

الاسم : \_\_\_\_\_

المدرسة : \_\_\_\_\_

المستوى الأول : \_\_\_\_\_ العام الدراسي : \_\_\_\_\_





# وحداتي

## المستوى الأول

- 3- وحدة أهلاً وسهلاً \_\_\_\_\_
- 8- وحدة أنا \_\_\_\_\_
- 17- وحدة العائلة \_\_\_\_\_
- 23- وحدة المسكن \_\_\_\_\_
- 29- وحدة رمضان \_\_\_\_\_
- 34- وحدة الملابس \_\_\_\_\_
- 42- وحدة اليوم الوطني \_\_\_\_\_
- 49- وحدة الطعام والشراب \_\_\_\_\_
- 55- وحدة الحيوانات \_\_\_\_\_
- 63- وحدة الصحراء \_\_\_\_\_
- 70- وحدة الحج \_\_\_\_\_
- 77- وحدة النباتات \_\_\_\_\_
- 82- وحدة الماء \_\_\_\_\_
- 87- وحدة المواصلات \_\_\_\_\_
- 93- وحدة السيرة النبوية \_\_\_\_\_
- 99- وحدة السياحة \_\_\_\_\_
- 104- وحدة الكتاب \_\_\_\_\_
- 110- وحدة البيئة \_\_\_\_\_
- 115- وحدة الفضاء \_\_\_\_\_
- 121- وحدة مع السلامة \_\_\_\_\_





@Arabic\_Books

وبدة

أهلاً وسهلاً





أخطط أفقي.

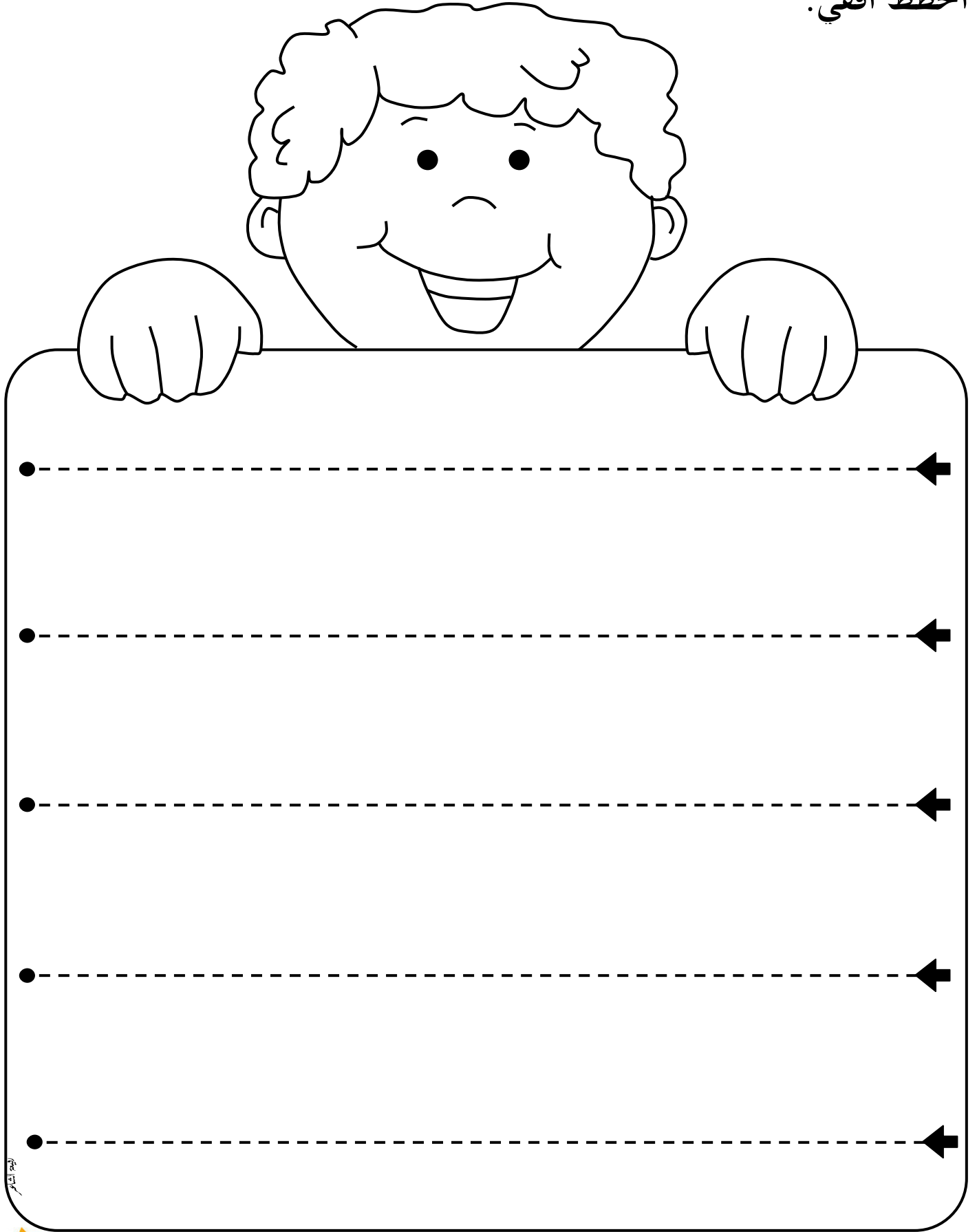



أخط عمودي.

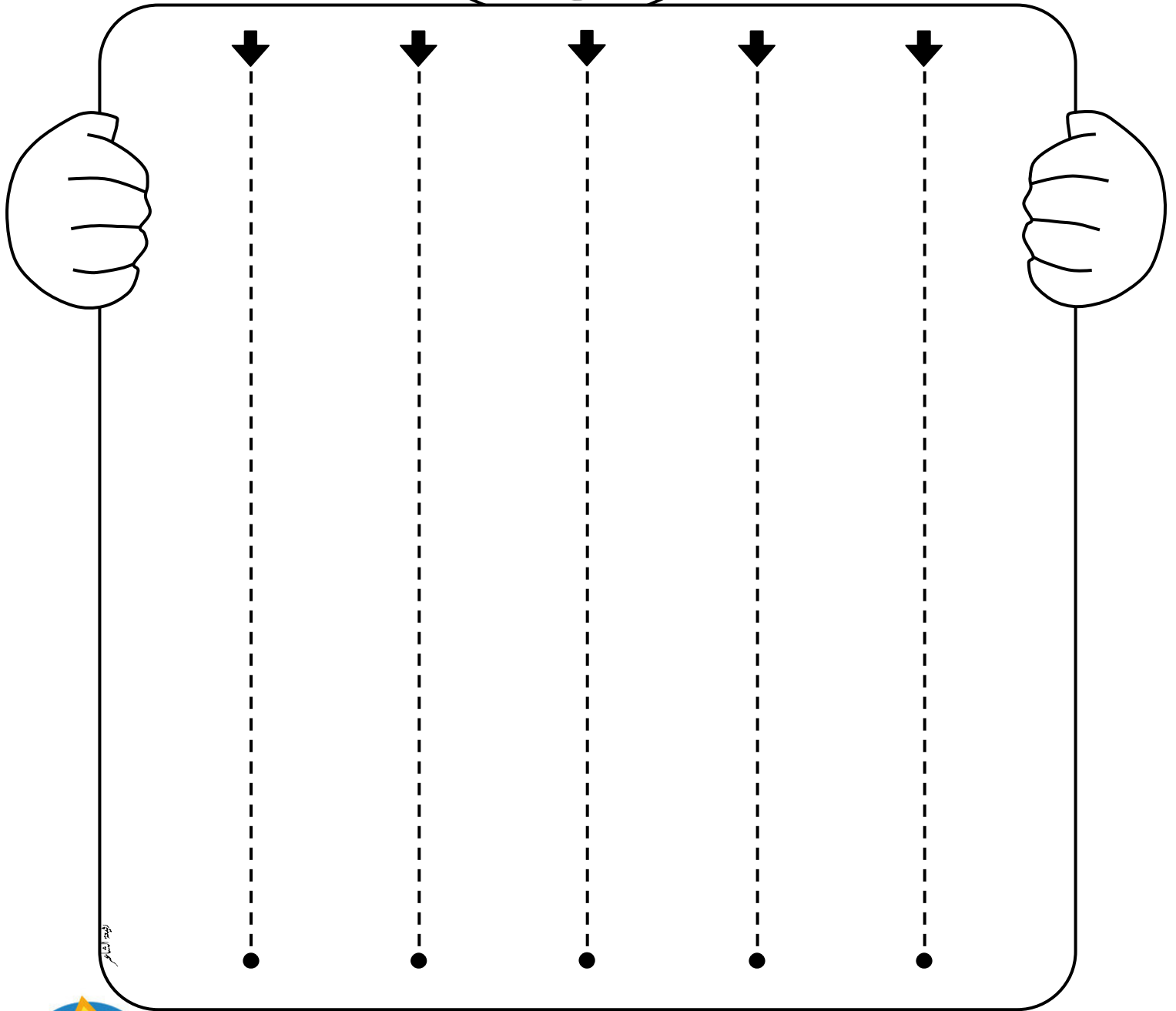
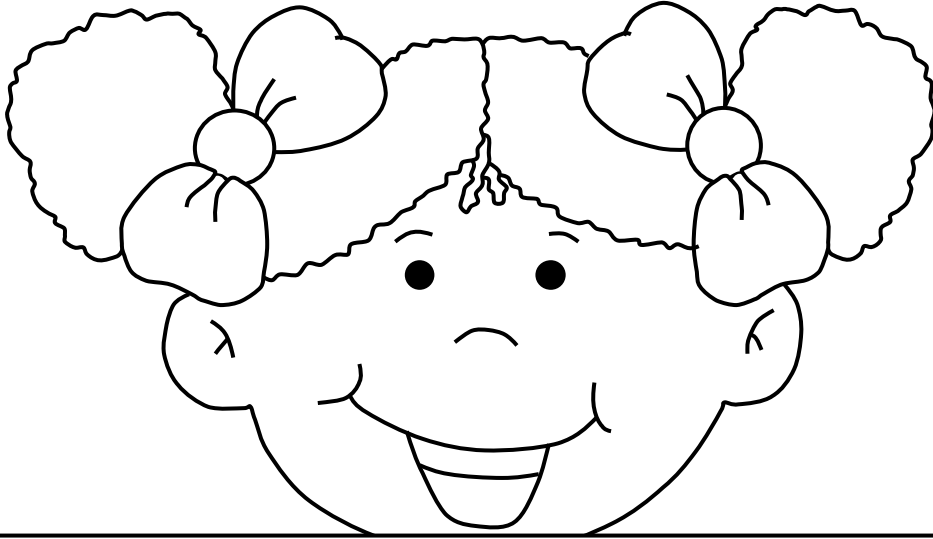

ماذا يوجد في صفّي؟ ألون.

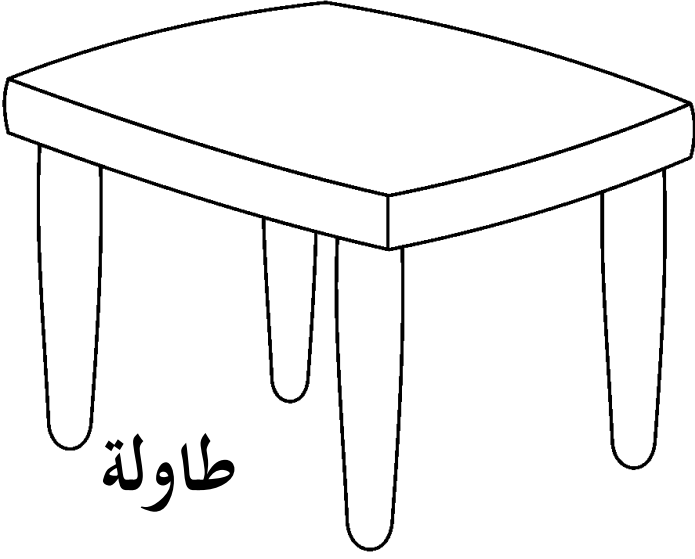

طاولة

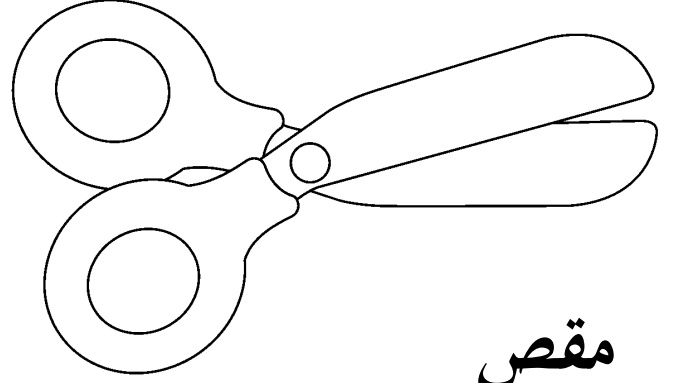

مقص

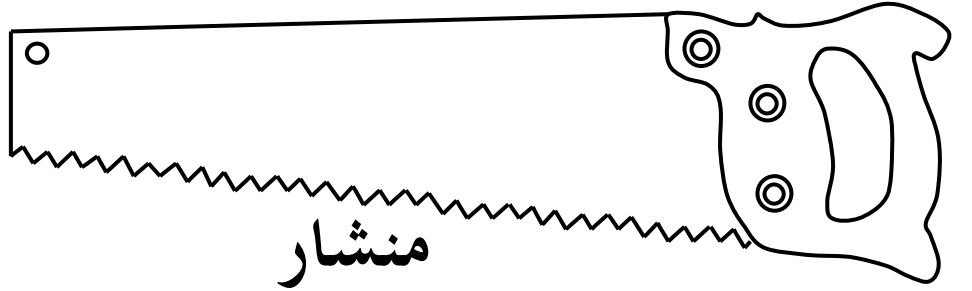

منشار

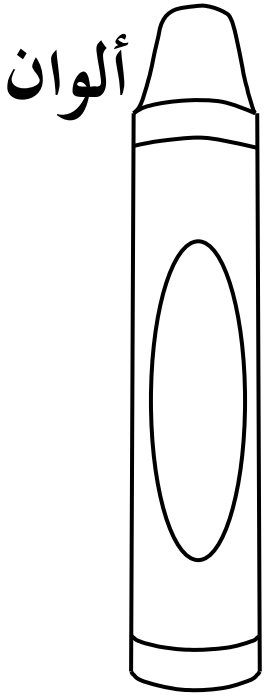

ألوان

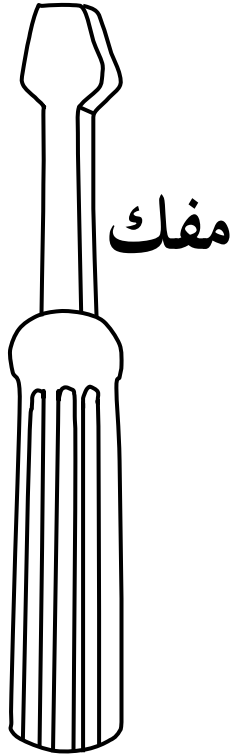

مفك

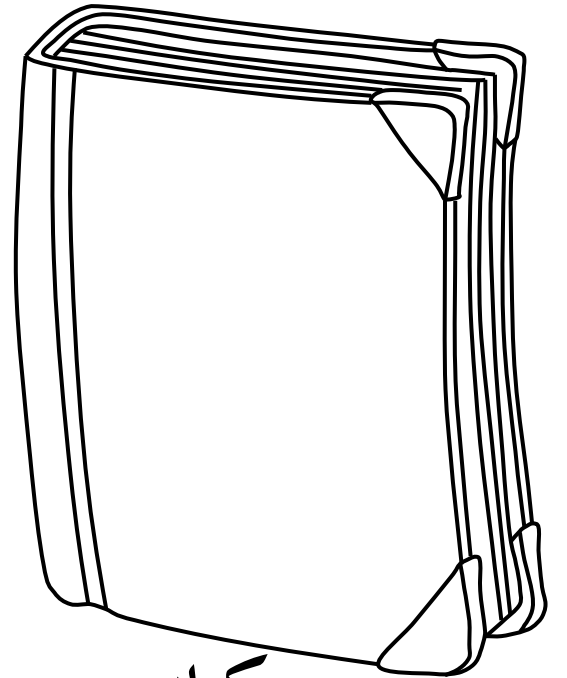

كتاب





ماذا يوجد في روضتي؟ ألون.

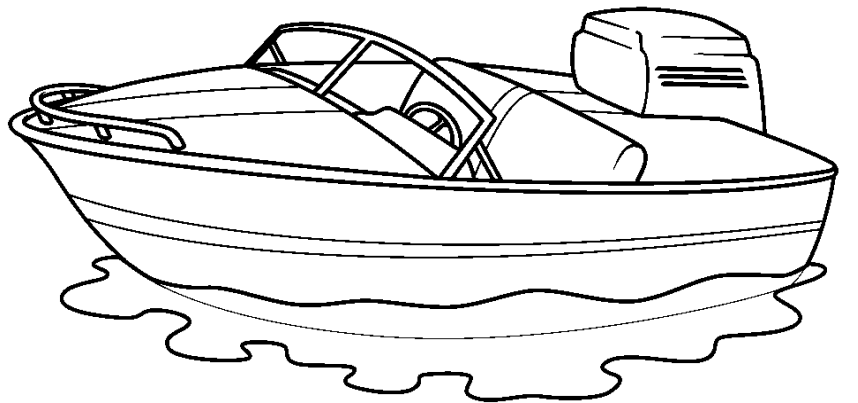
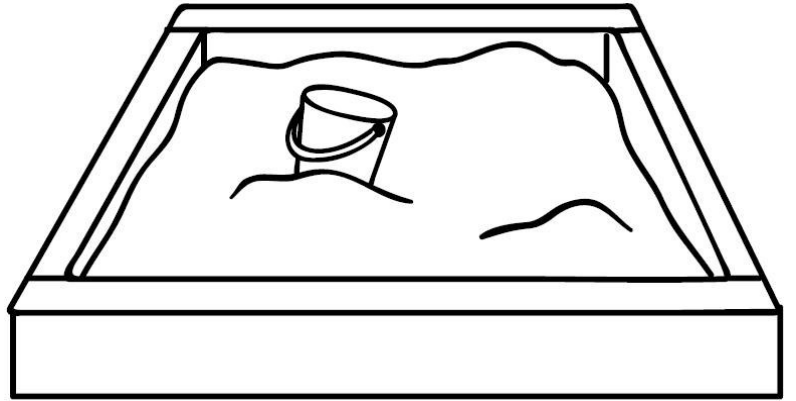
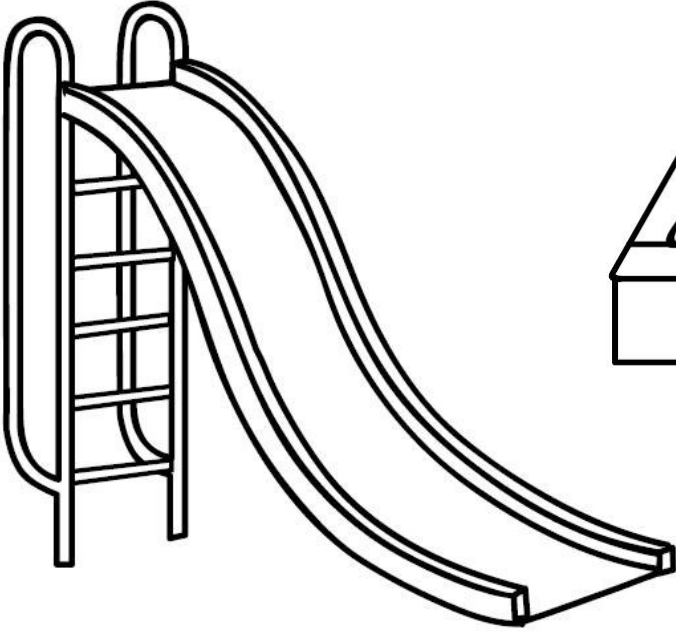
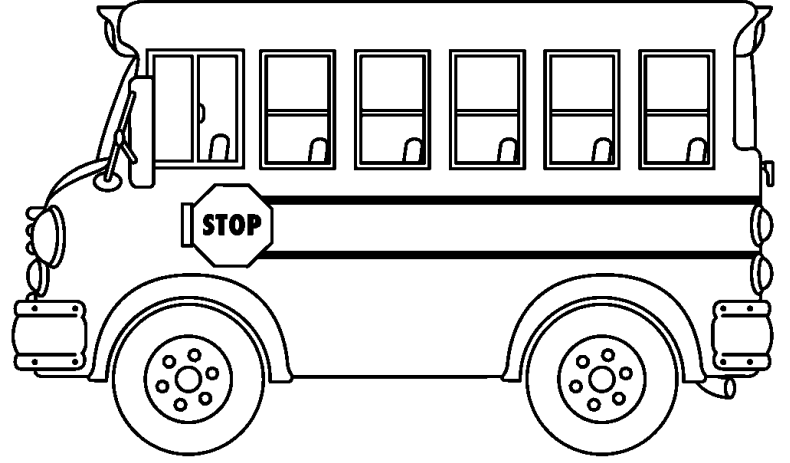
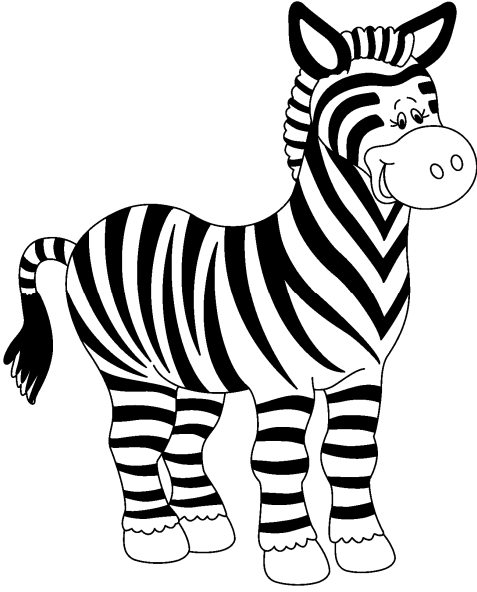





@Arabic\_Books

وَبَدَّةٌ

أَنَا





من أنا ؟ ألّون

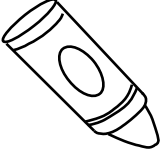

بنت



ولد





أجزاء جسمي تتحرك، أحوط ما يحركه الولد في الأفعال التالية (يد ، رجل).

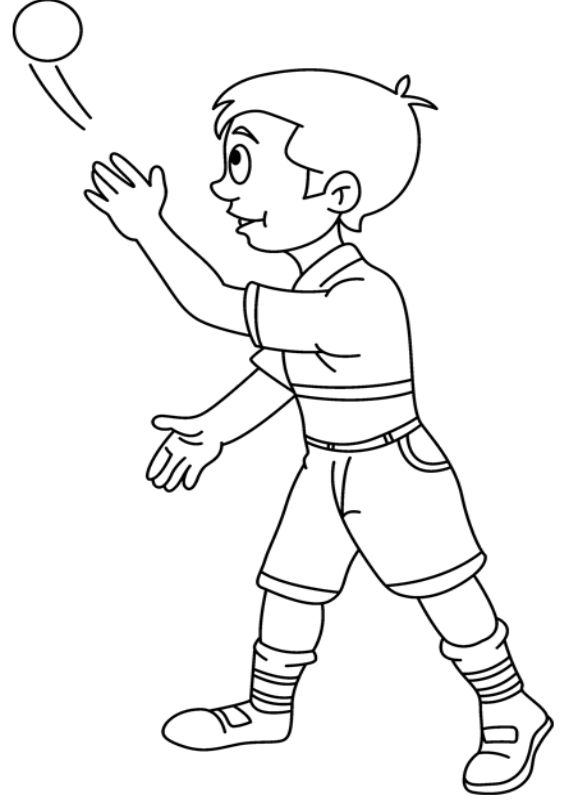

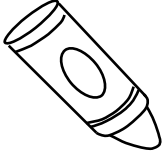

أنظف أسناني وأحافظ على نظافة جسمي.

أسناني  
نظيفة



جسمي  
نظيف

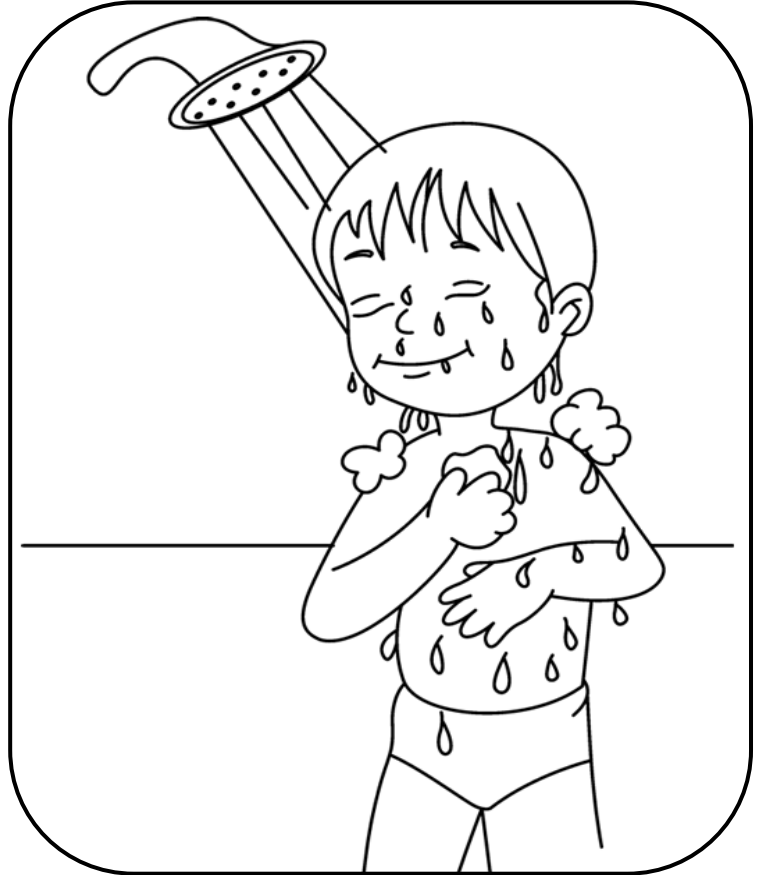

أنا لي حواس أصل الشيء بالحاسة المناسبة.

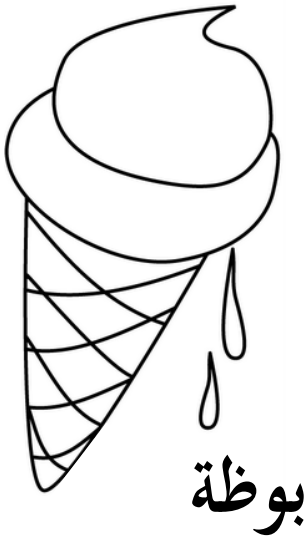
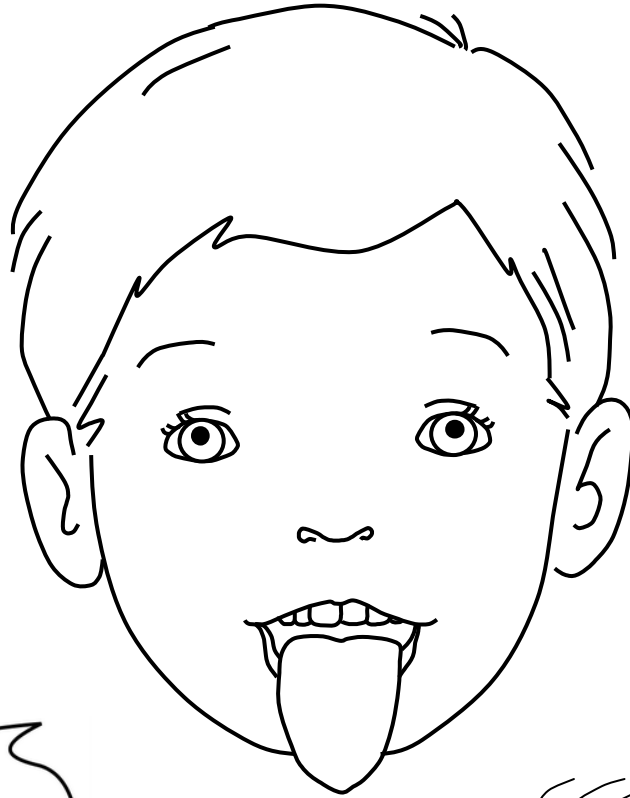
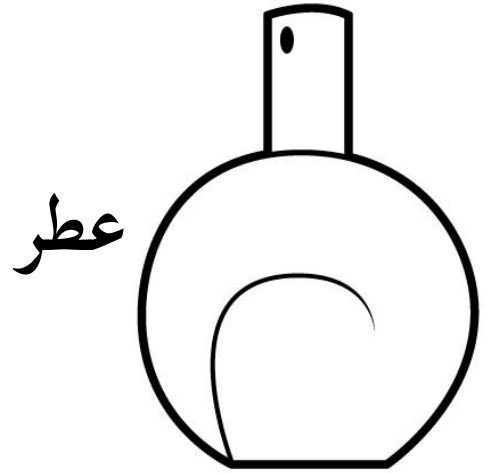

مشاعرنا مختلفة، مشاعرنا تتغير، أظابق وأصل.

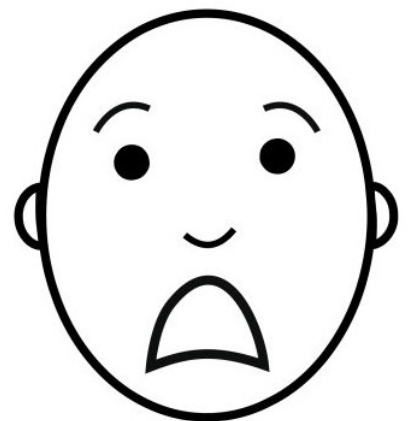
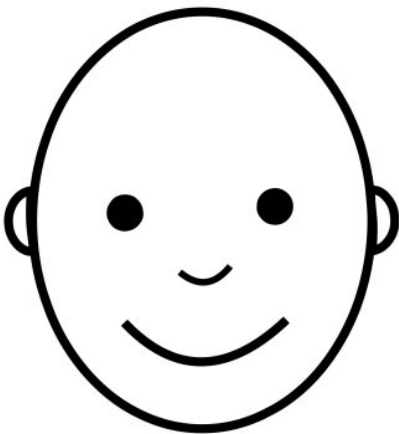
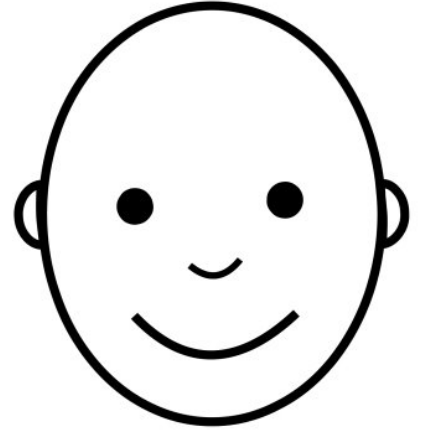
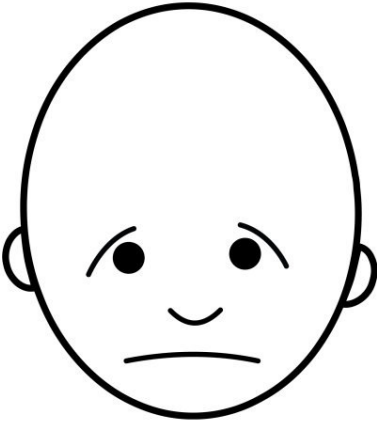
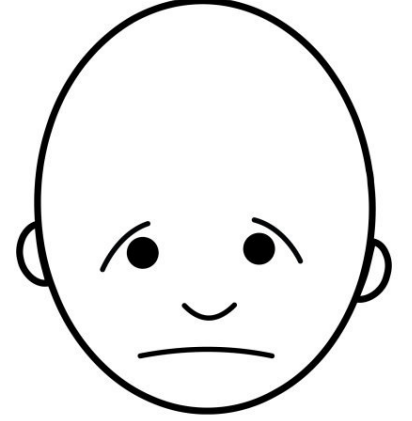
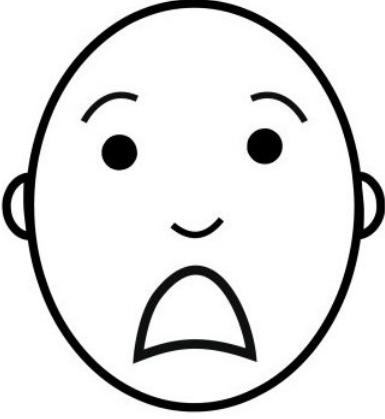

## أرسم شكل الدائرة.

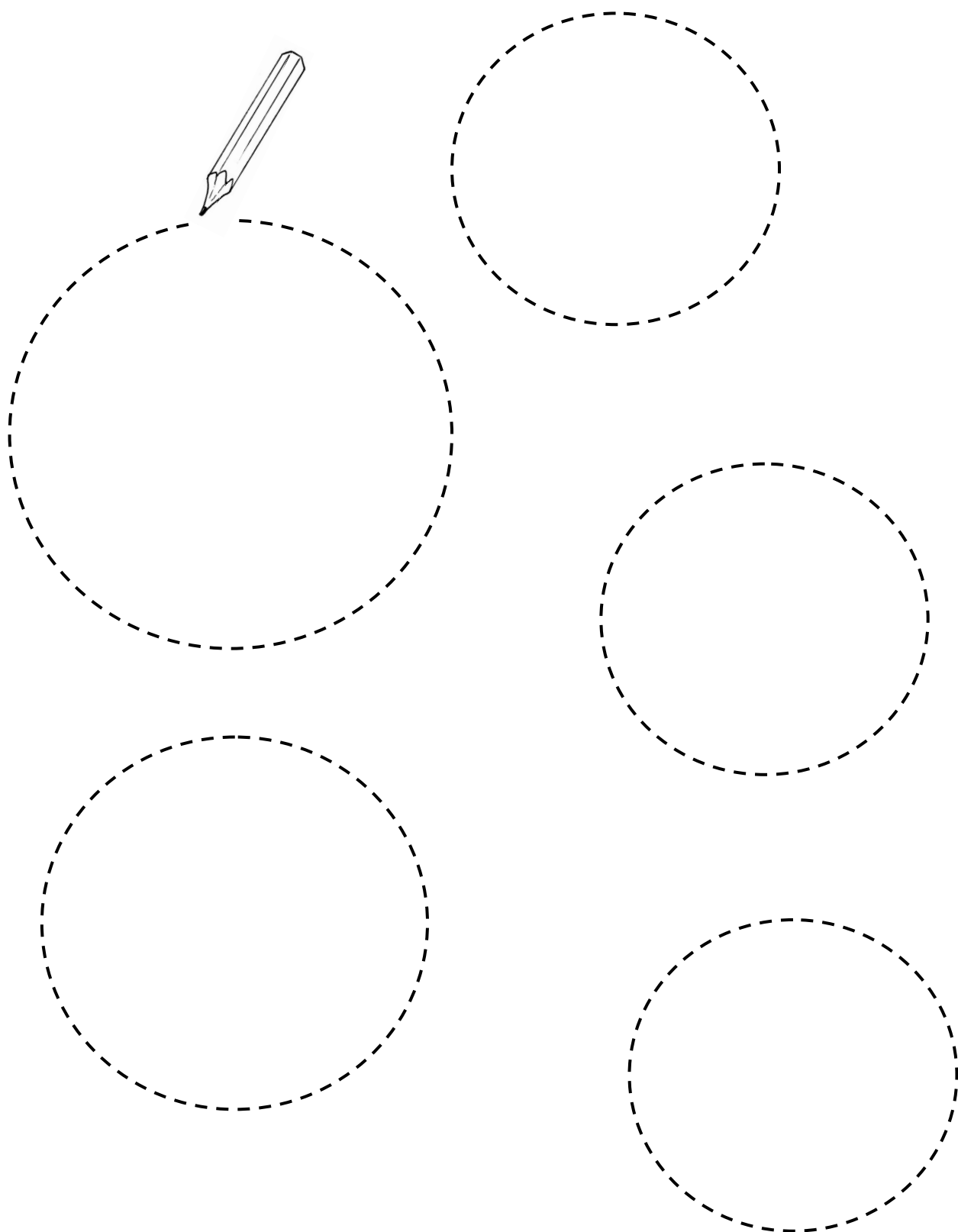

" طويل ، قصير " ألّون ما حجمه طويل.

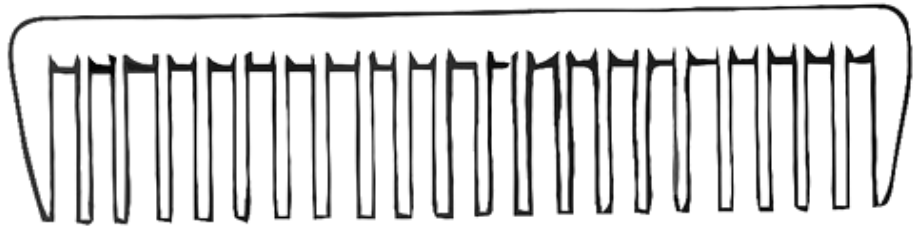
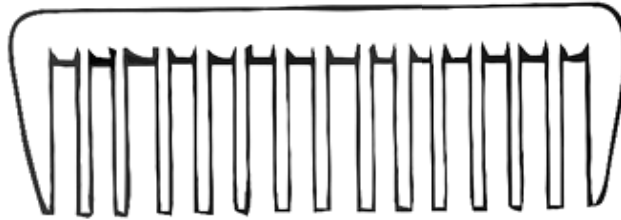
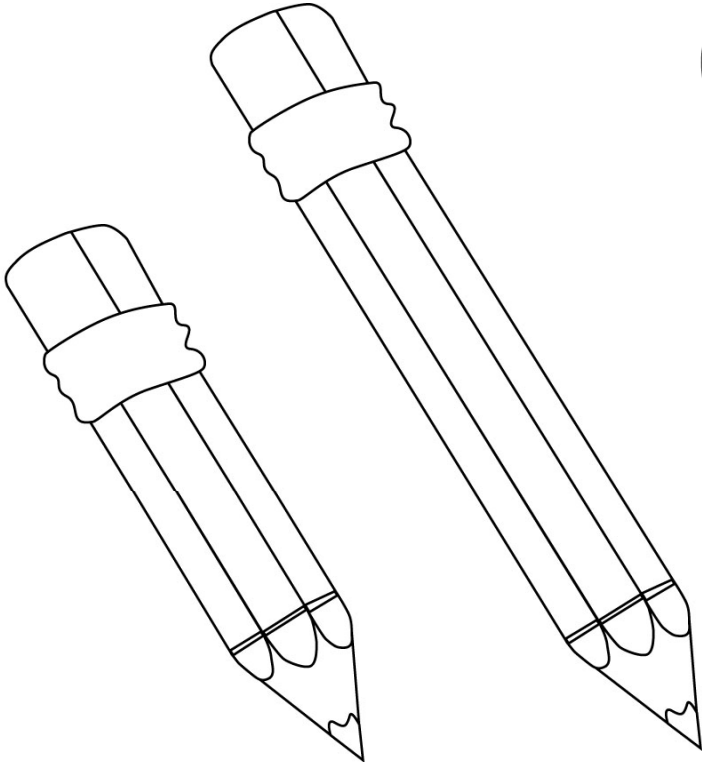
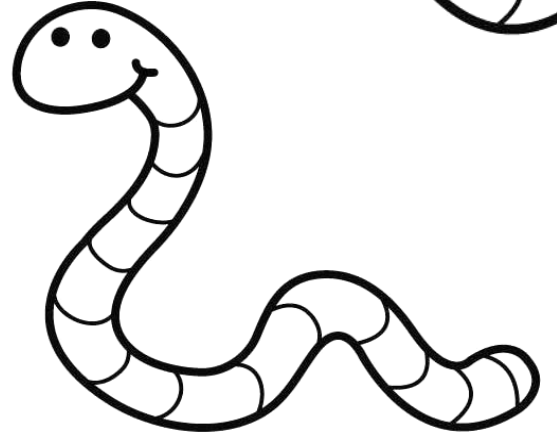
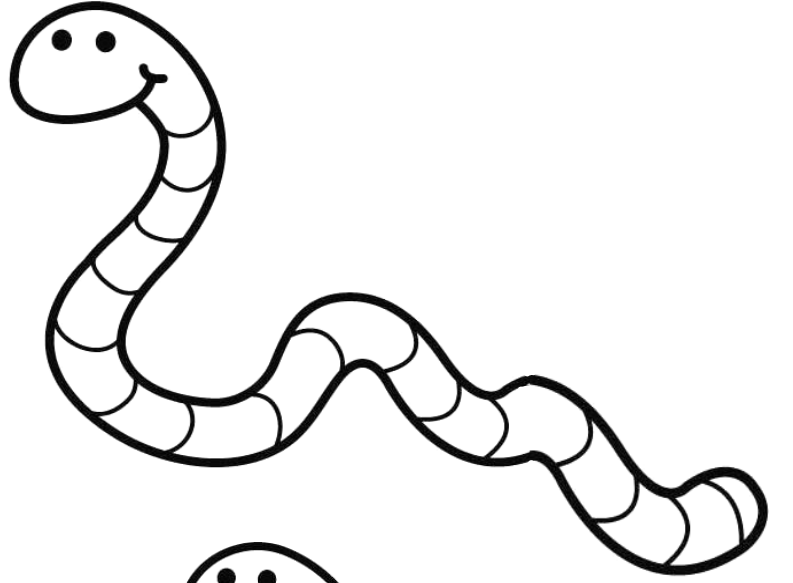



ألون ما شكله دائرة.

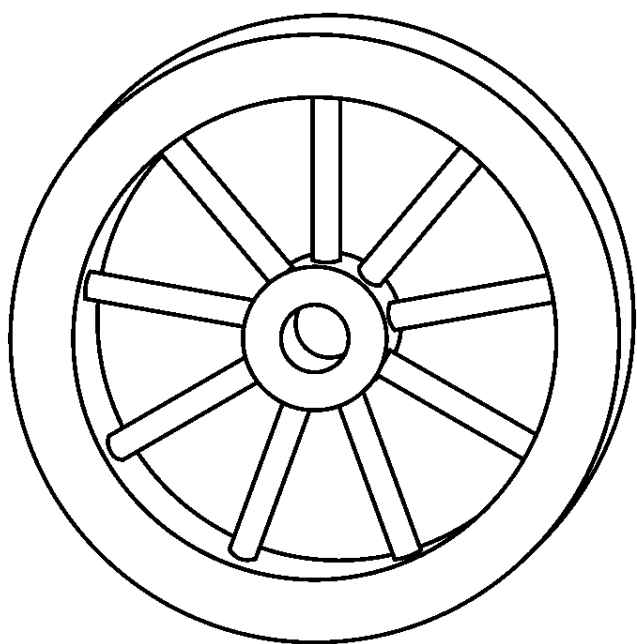
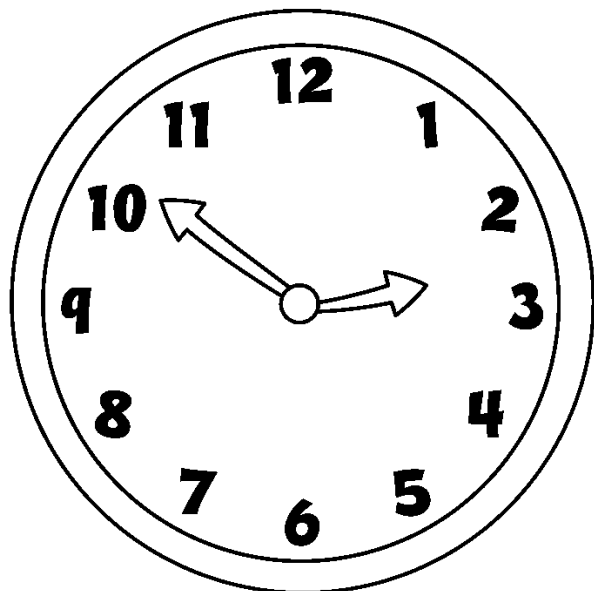
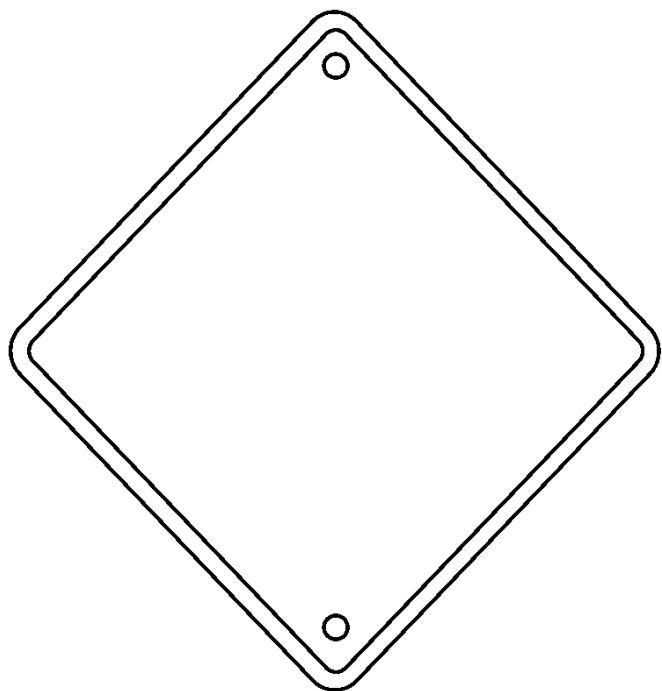



@Arabic\_Books

وحدّة

العائلة



## أفراد العائلة . أطابق وأصل.

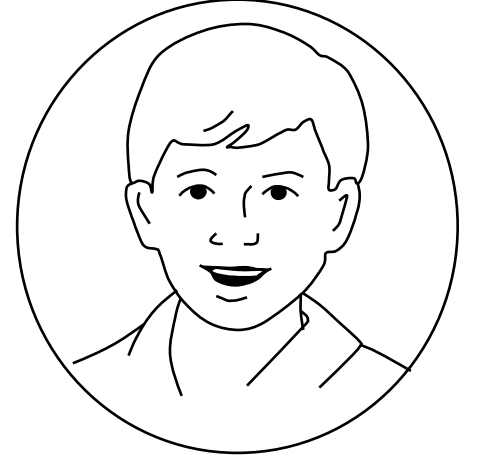
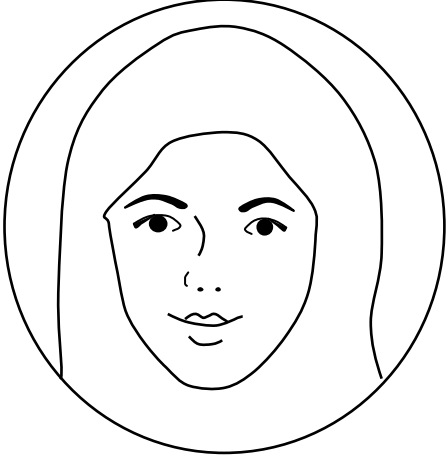
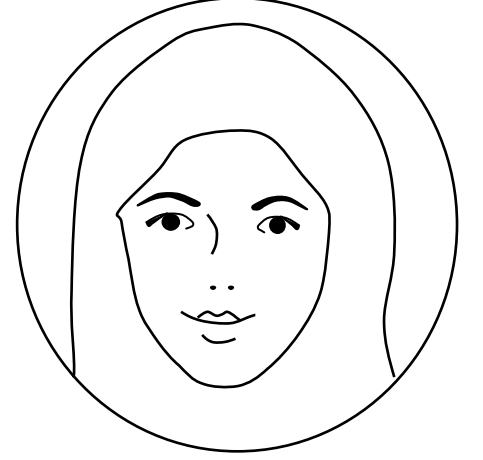

## أصل الطفل الرضيع بحاجياته.

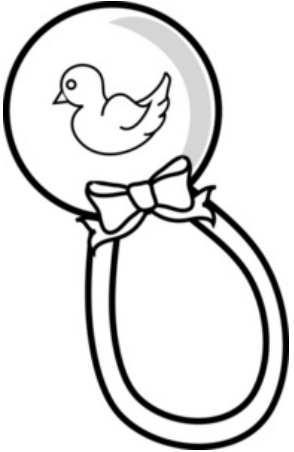
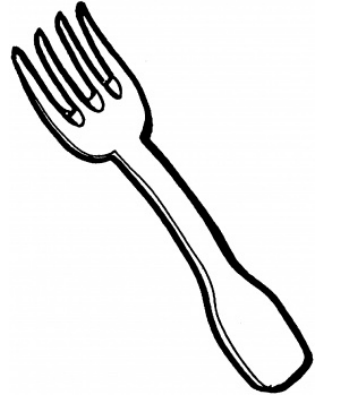
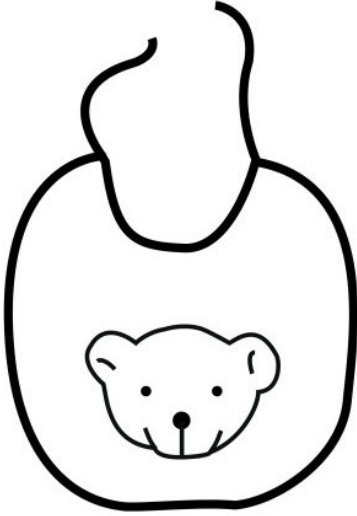
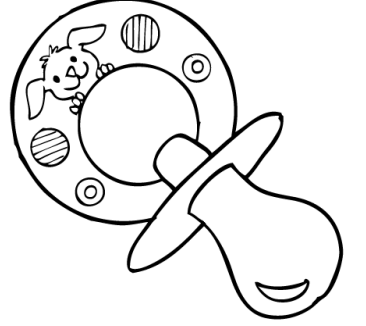
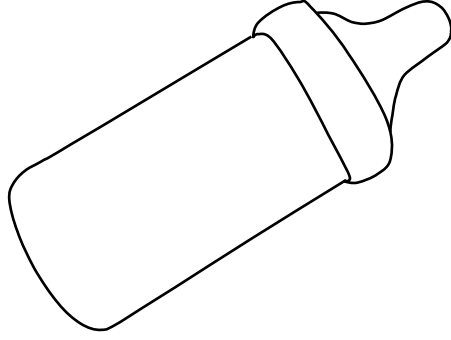
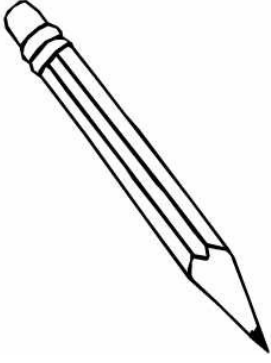

" كبير ، صغير " ألّون ما حجمه كبير .

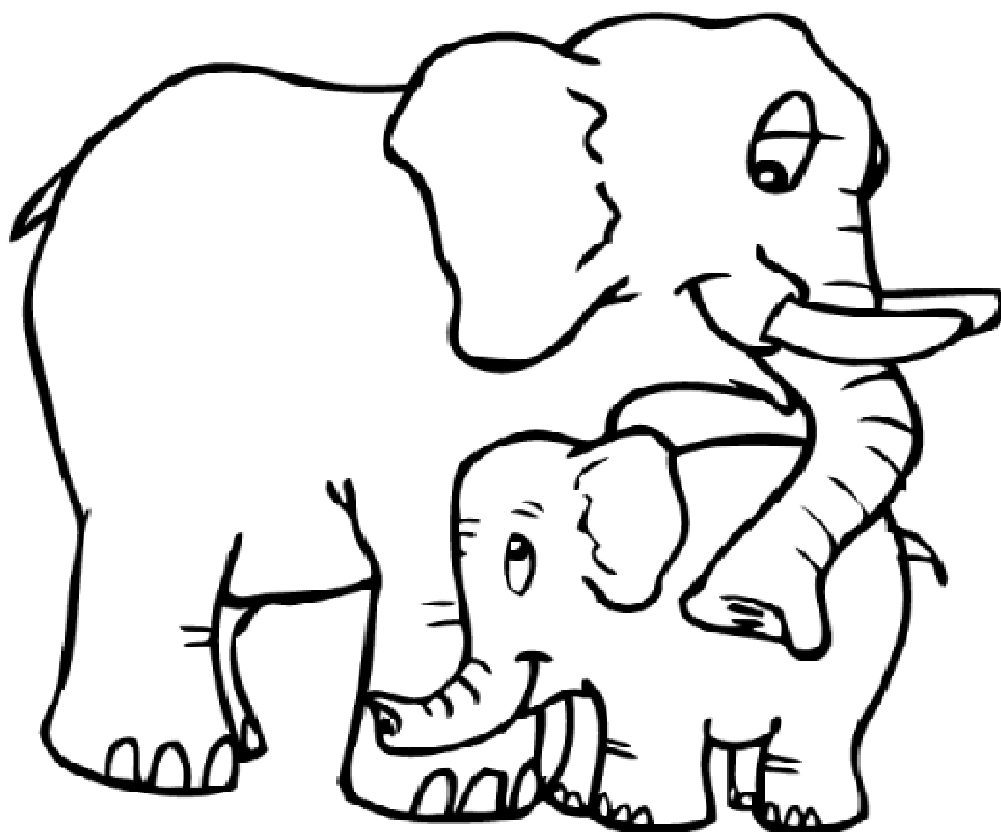

" فوق ، تحت " أرسم ○ على ما هو فوق . وأرسم × على ما هو تحت .

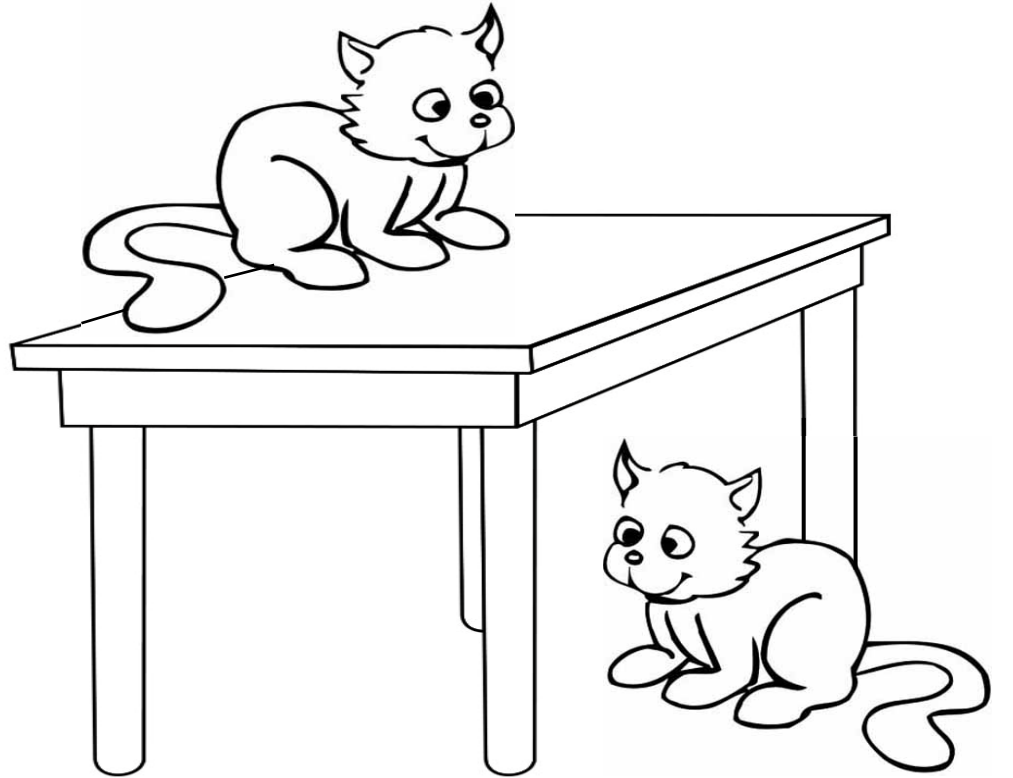
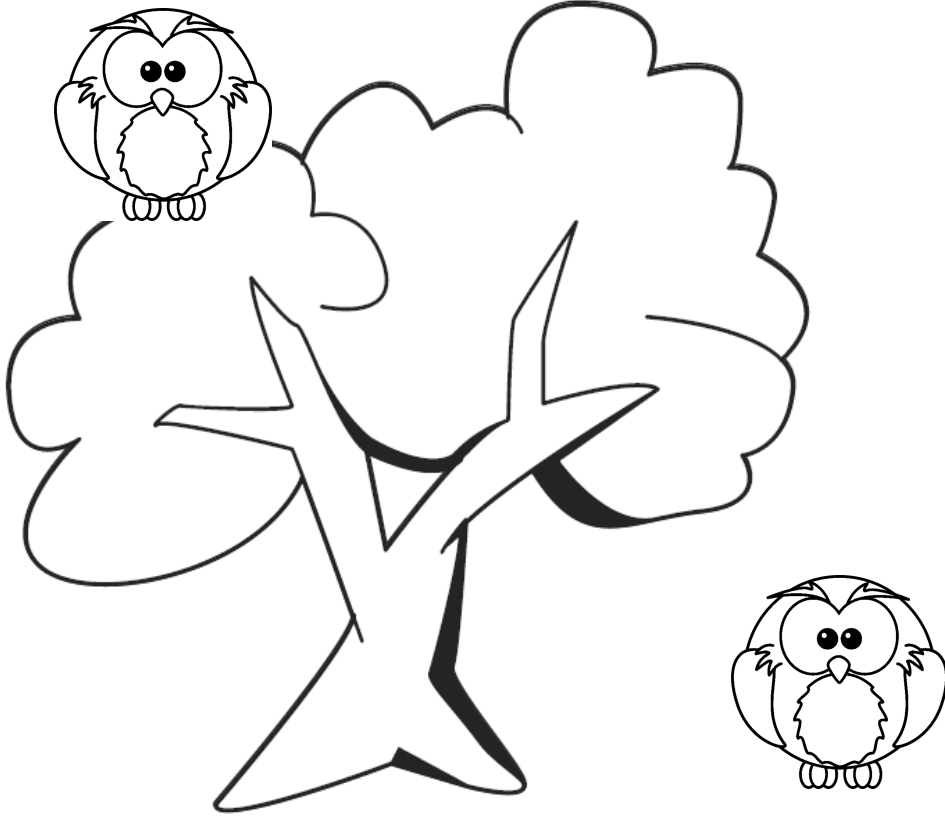

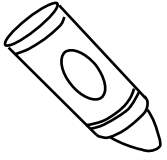

أمي و أبي





@Arabic\_Books

وحدة

المسكن





أتعرف على أنواع المساكن ، أقرأ وألون.

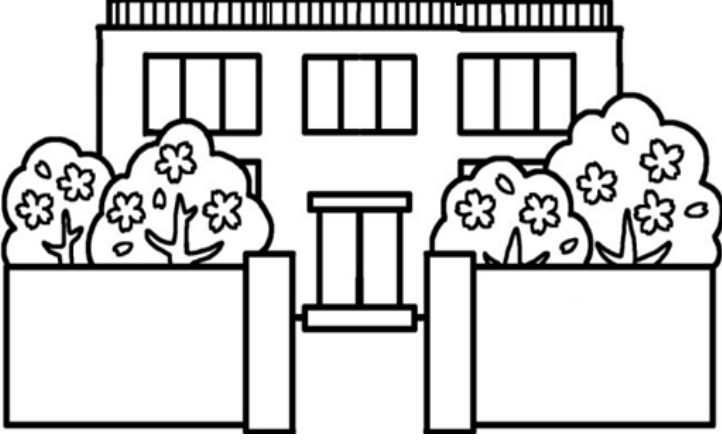

فيلا



خيمة

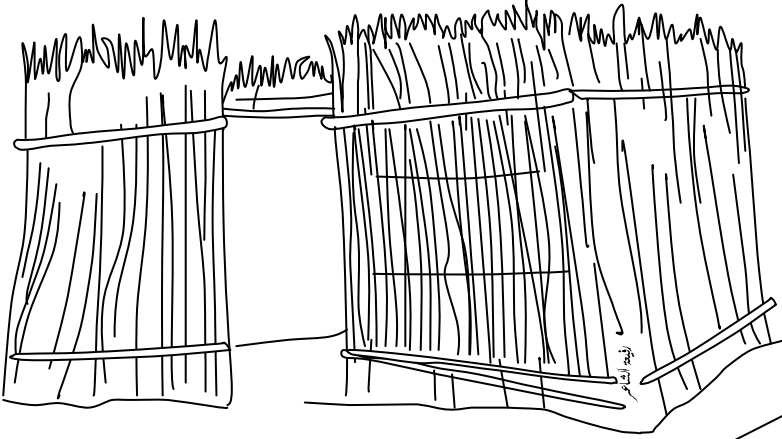

عريش

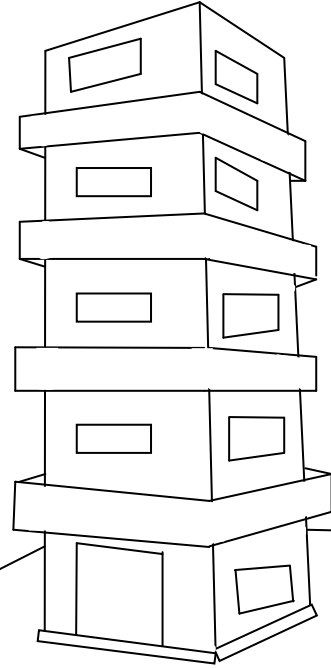

بناية



## أصل الشخص للغرفة المناسبة.

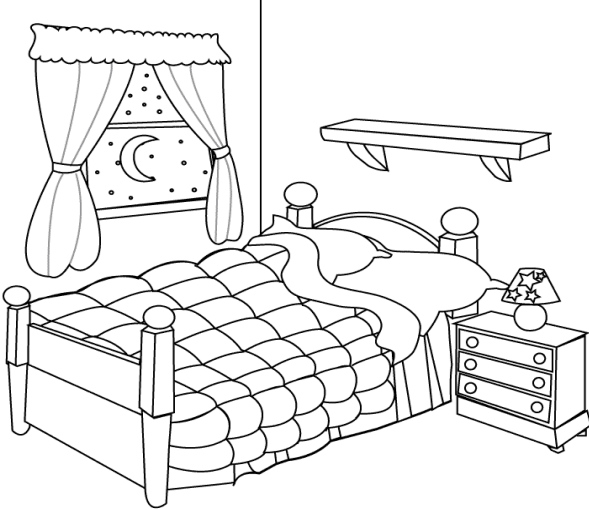
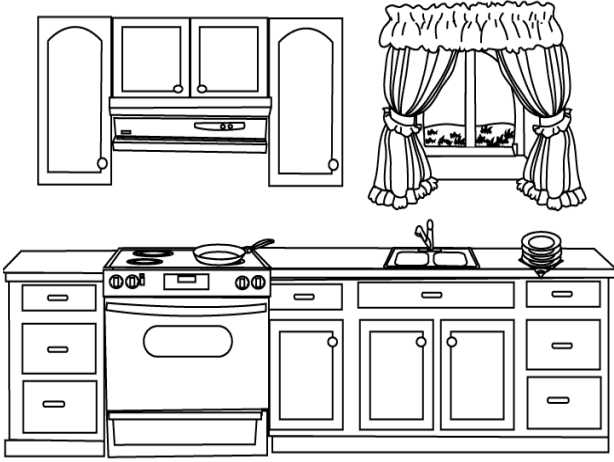



أبحث عن أدوات البناء وأحوظها.

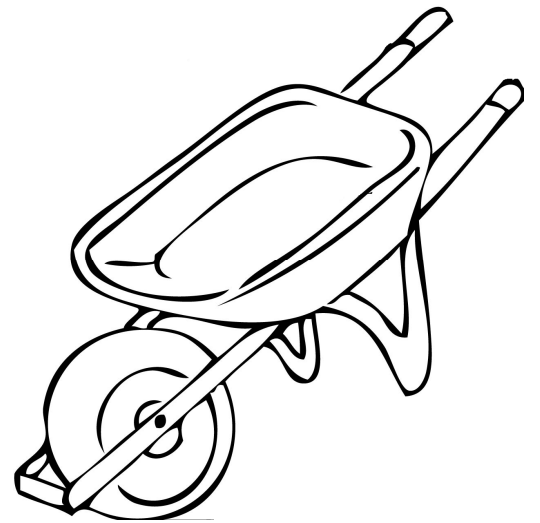
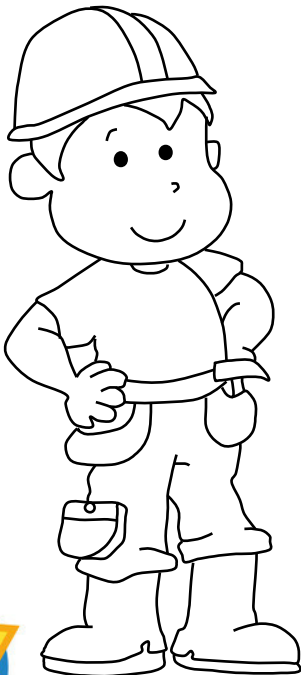
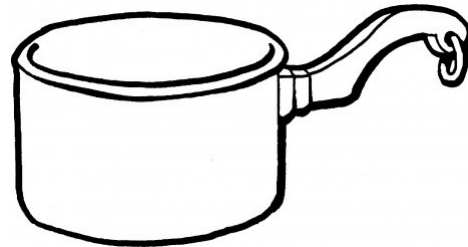
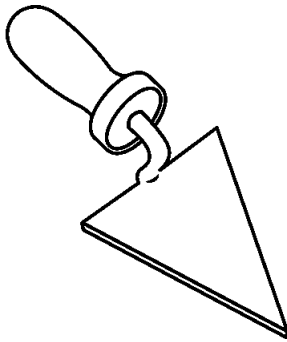
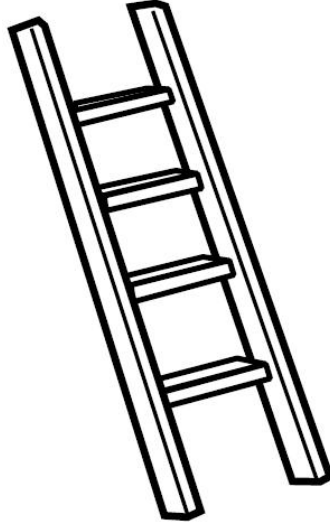
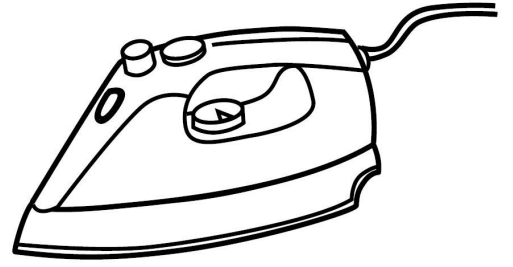
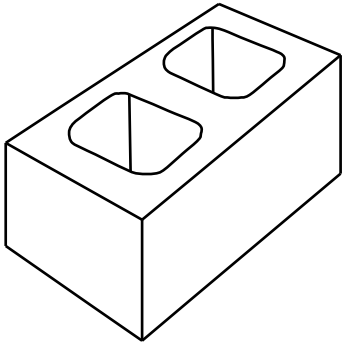

أرسم علامة **X** على السلوك الخاطئ.

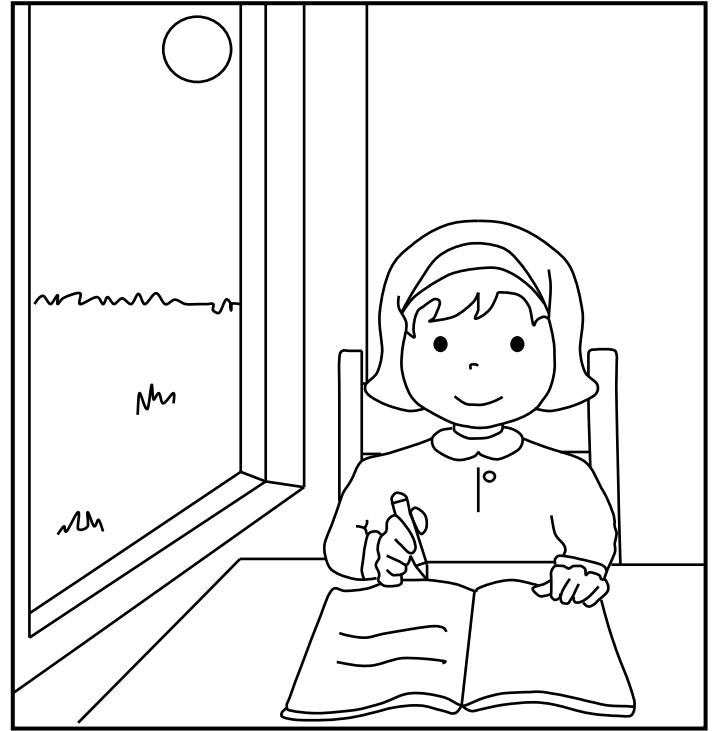
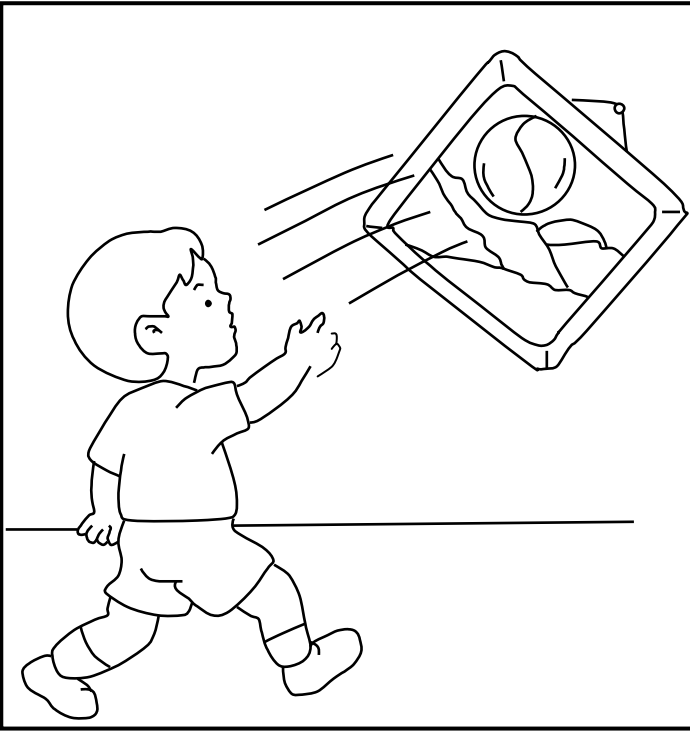
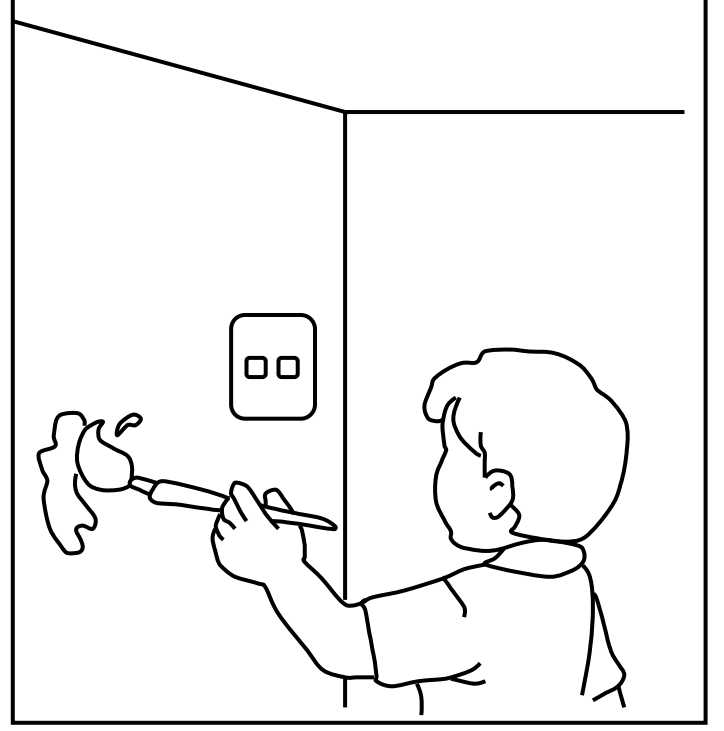

## أرسم شكل المربع.

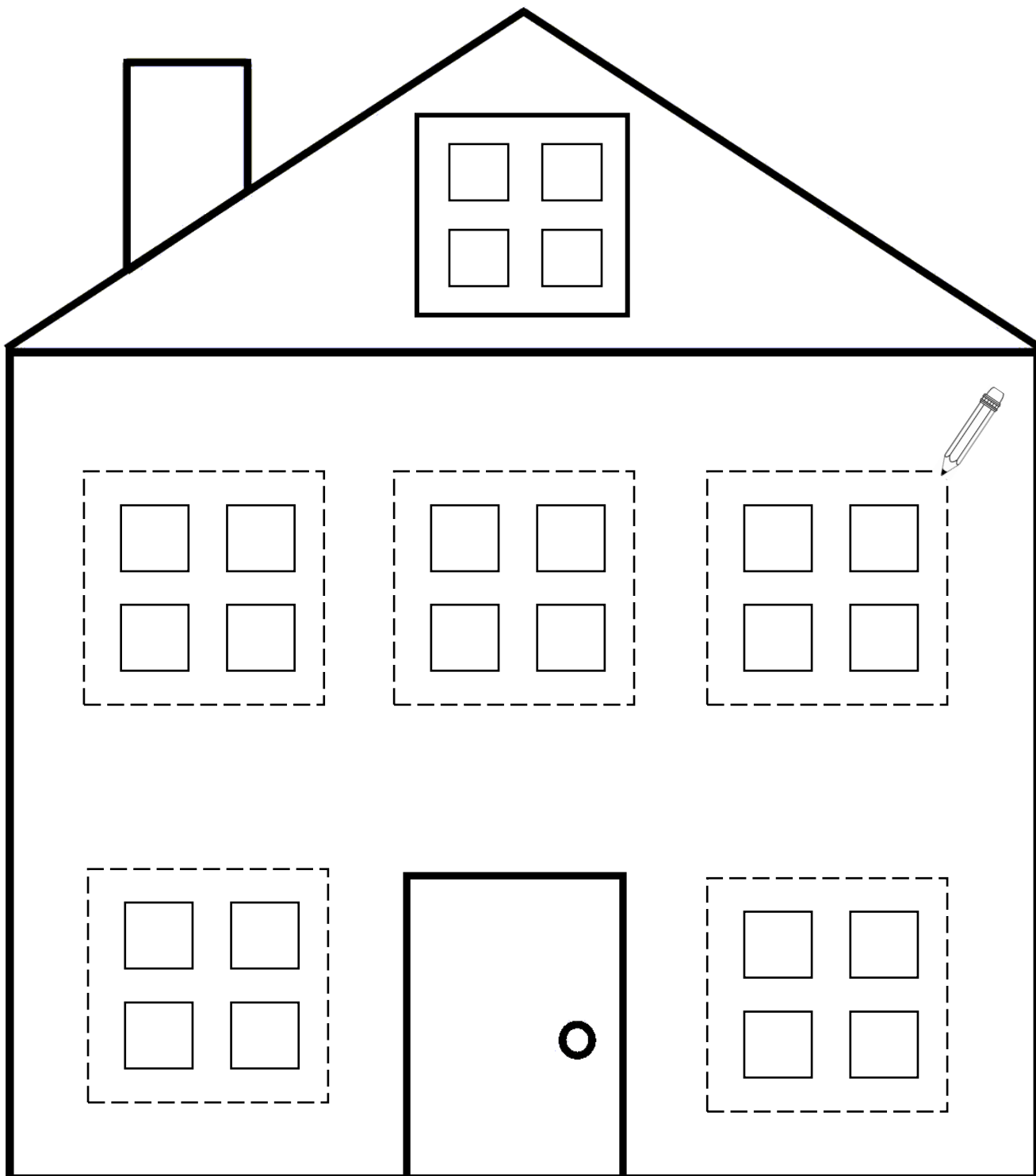



 @Arabic\_Books

وَبَدَّةُ

رَمَضَانَ



نكثر من العبادات في رمضان.

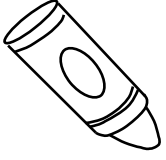

# أقرأ القرآن الكريم



# أدعوا ربي



# أصلي



أتعرف على بعض من أكالات رمضان ، أطابق وأصل.

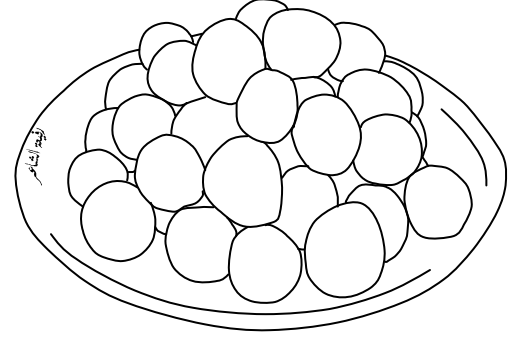
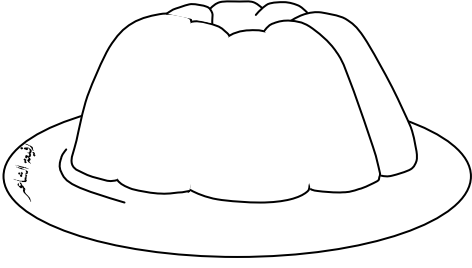

لقيمات

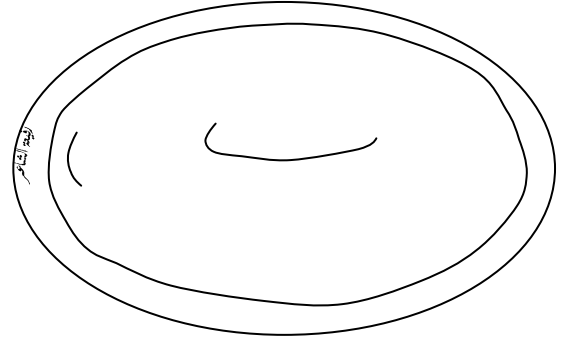
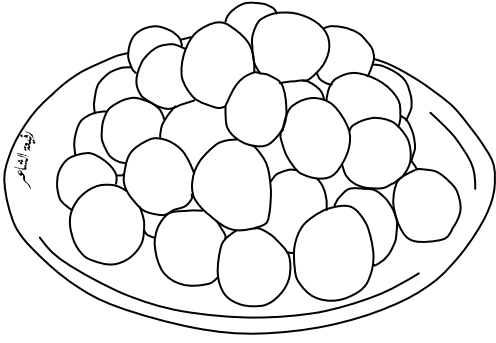

هريس

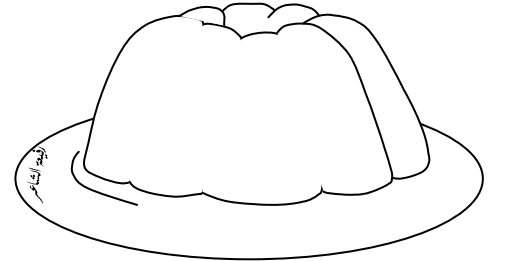
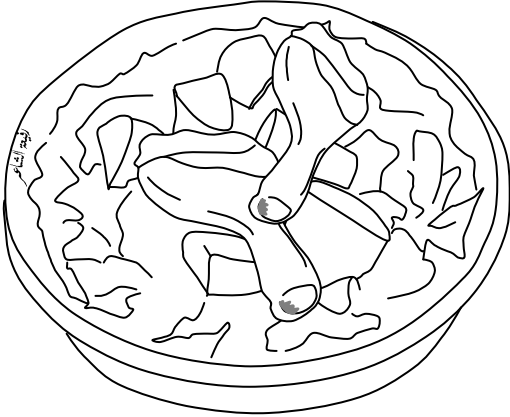

جيلي

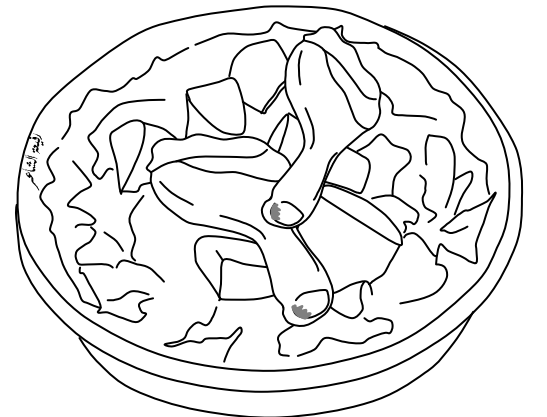
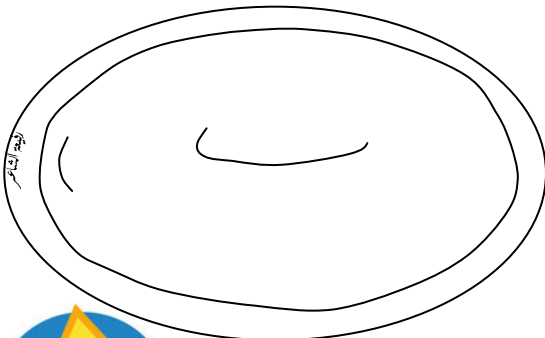

ثريد





## أصل الرجل وابنه إلى المسجد.

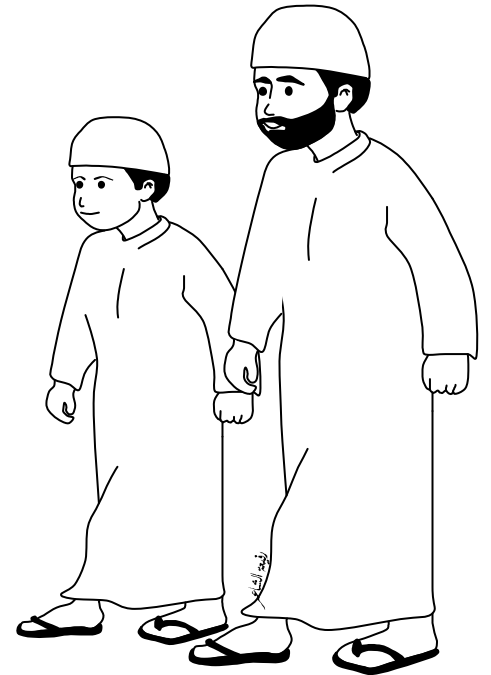
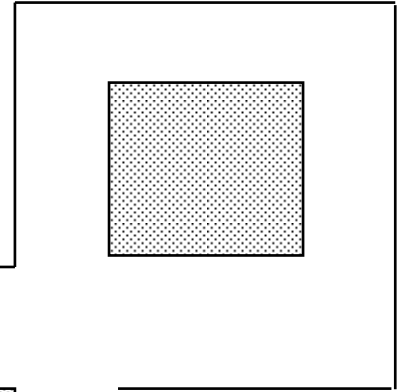
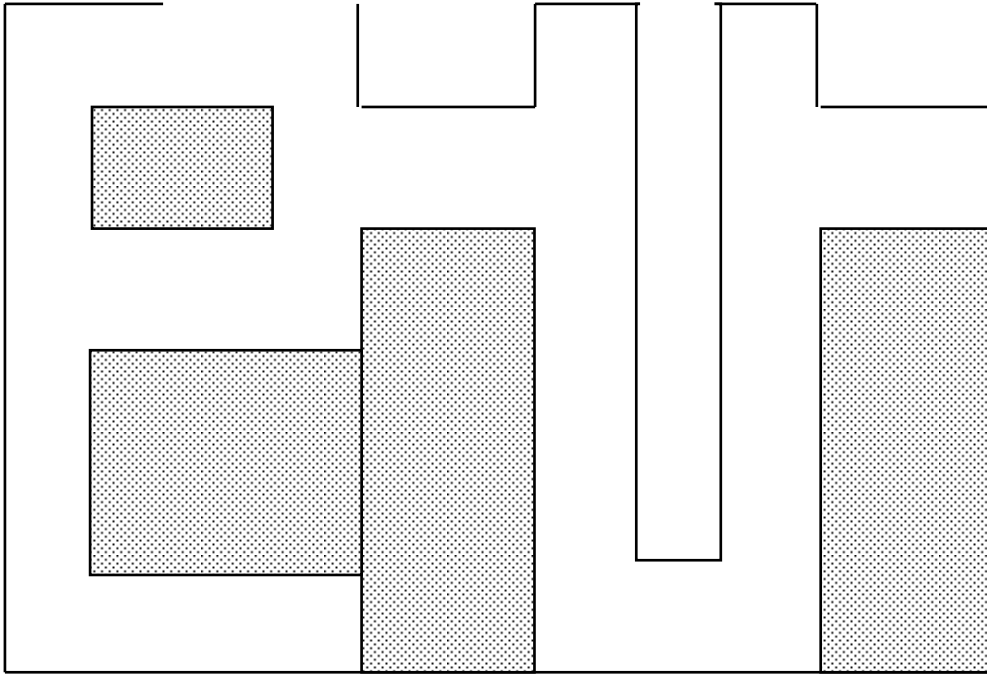
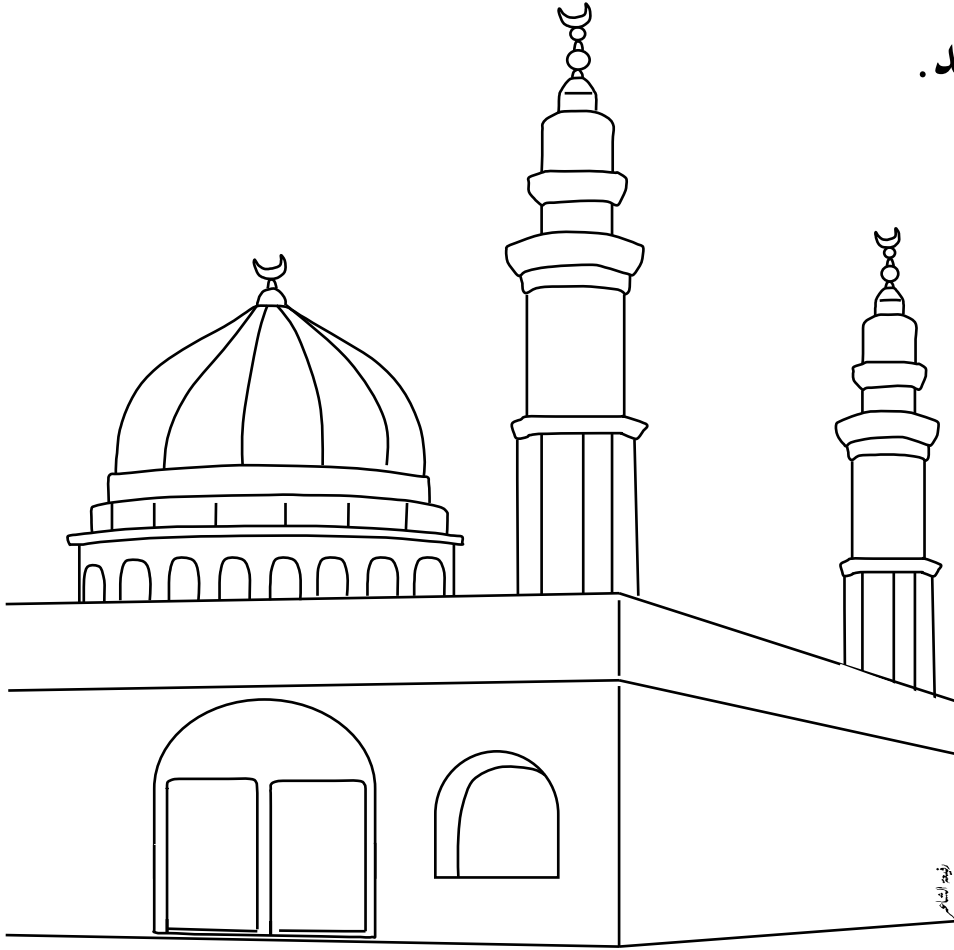

أخطط و ألون.

الله أكبر.. الله أكبر

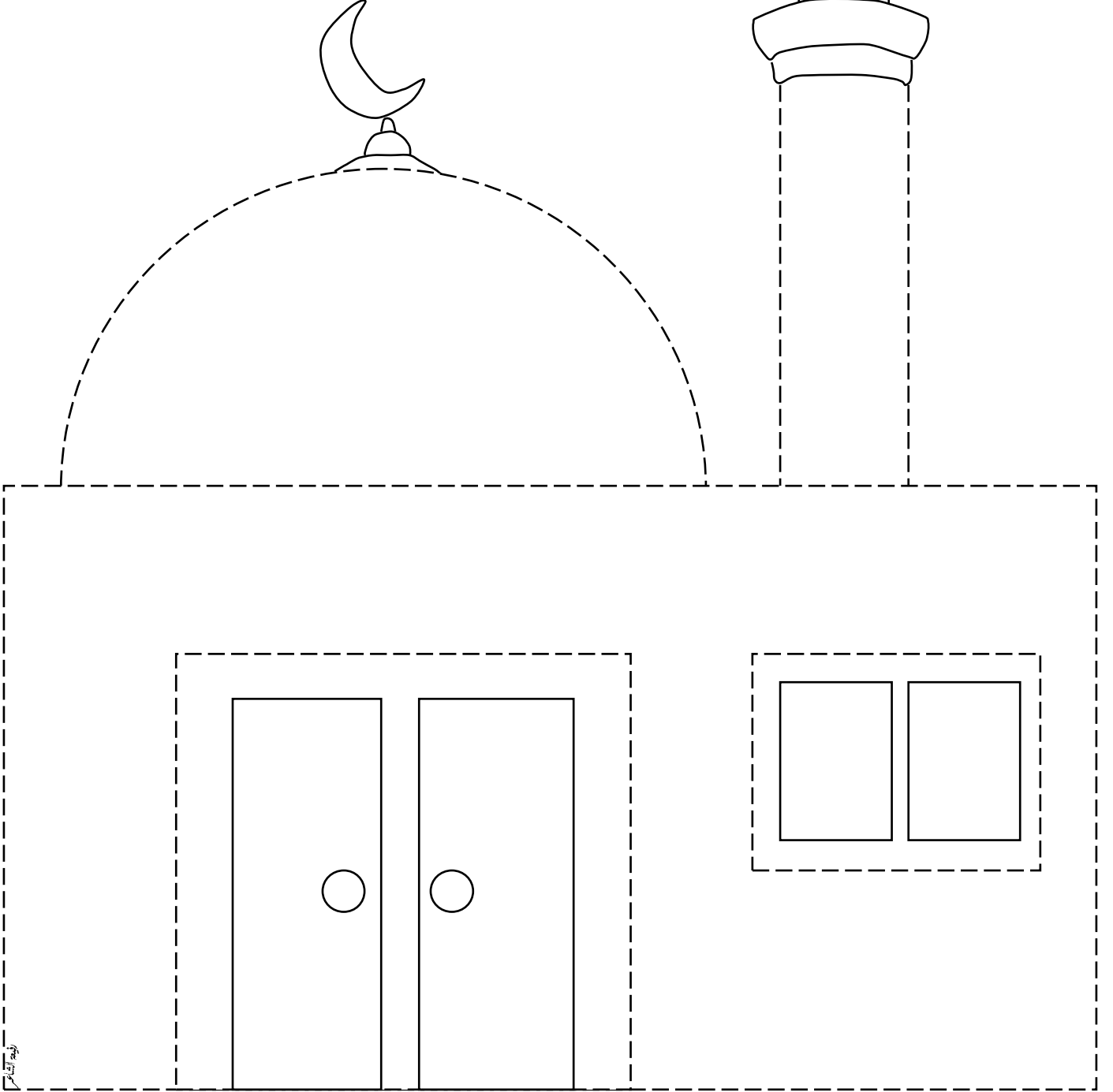
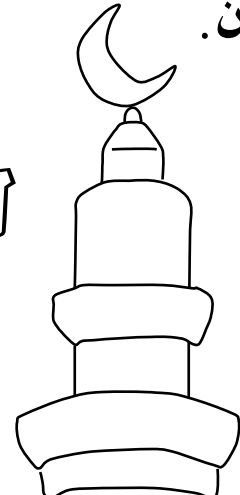



@Arabic\_Books

وحدة

الملبس



تختلف الملابس من حيث الاستعمال . أصل .

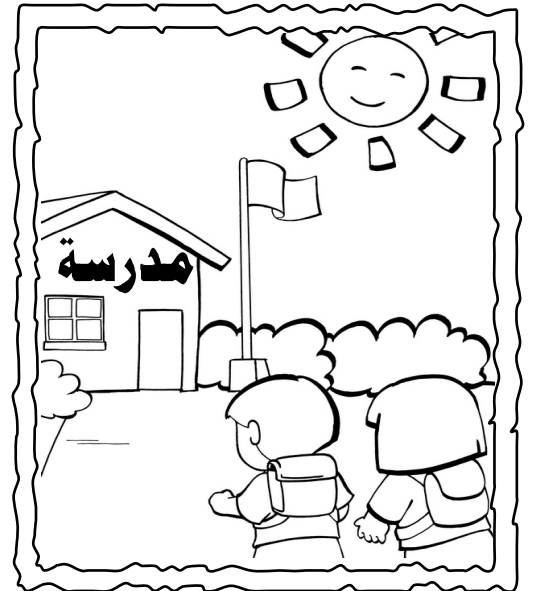

## أحوط الملابس المناسب لكل جزء من جسمي.

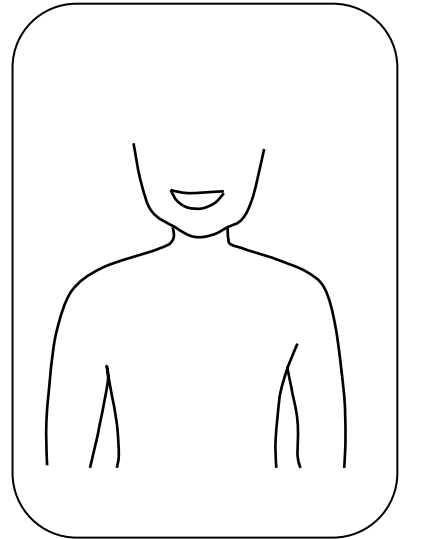
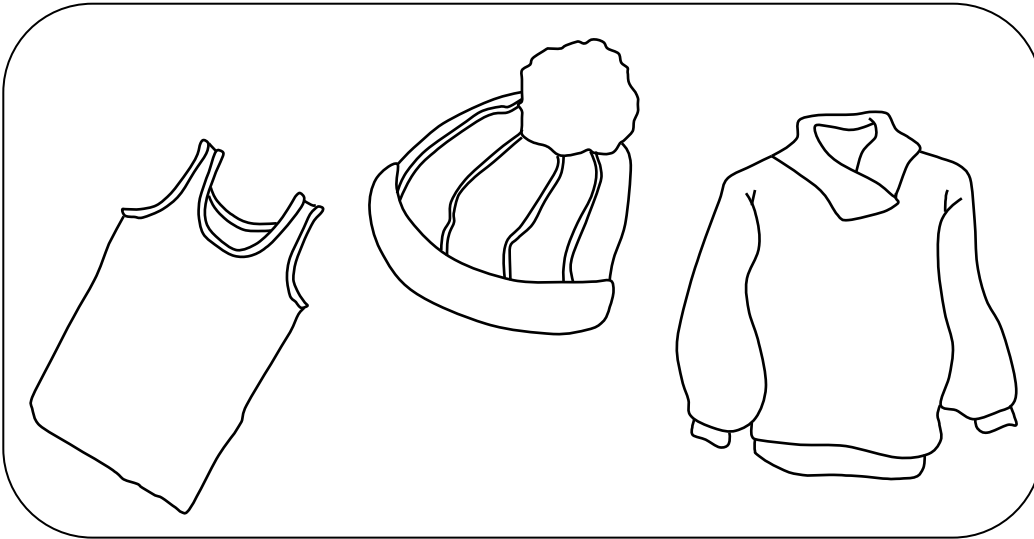
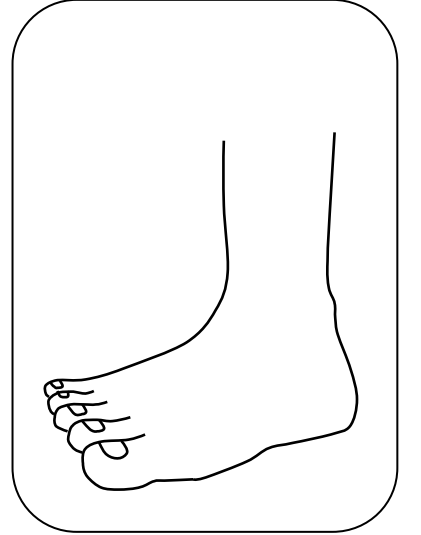
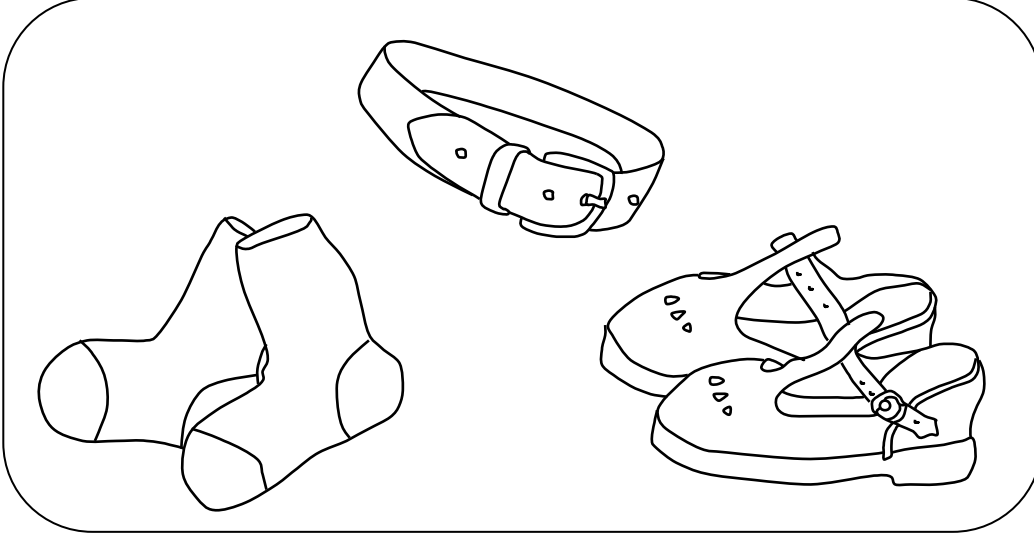
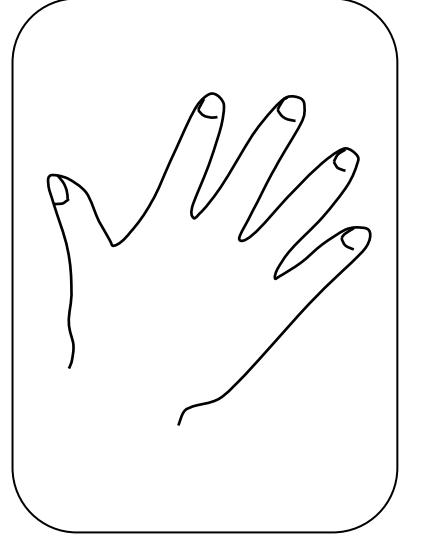
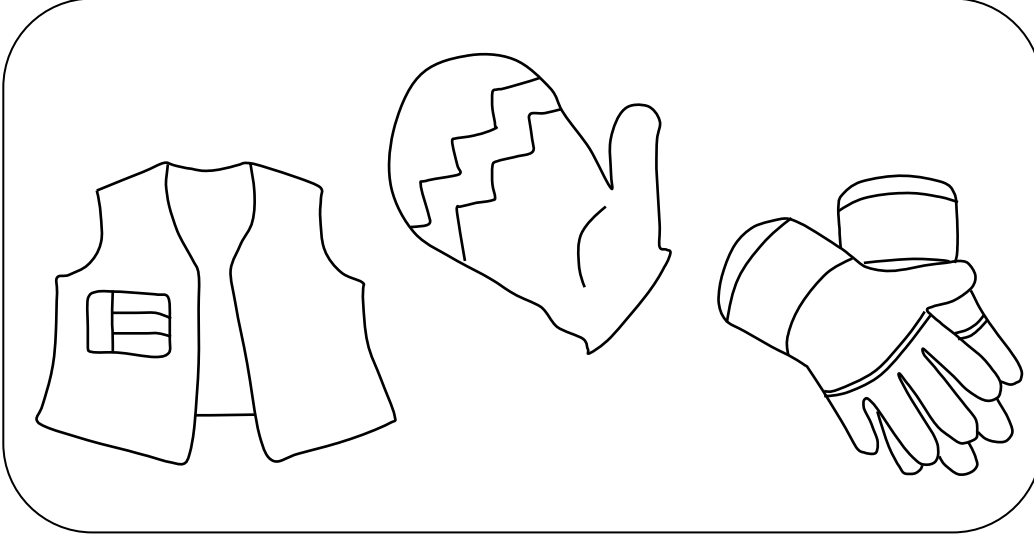

## أصل البنت بملابسها والولد بملابسه.

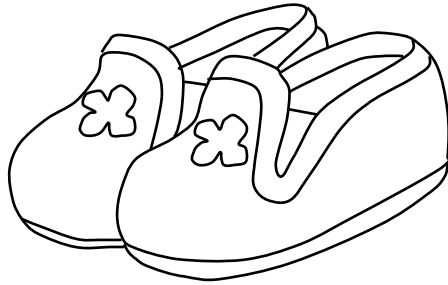
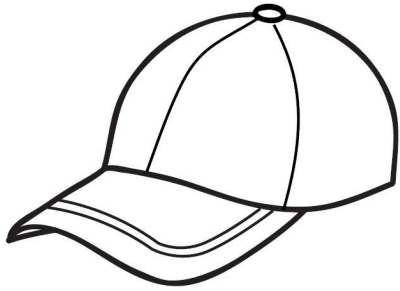
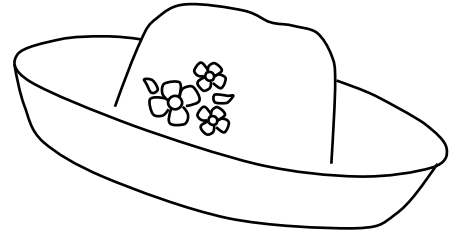
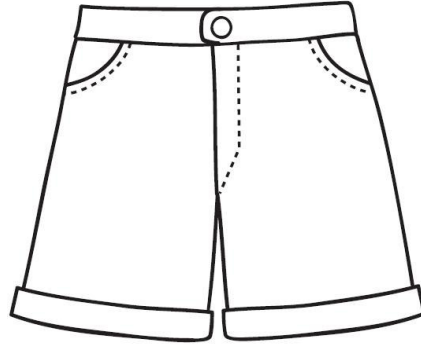
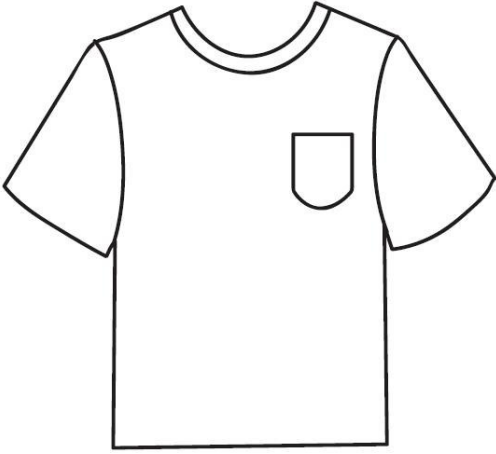
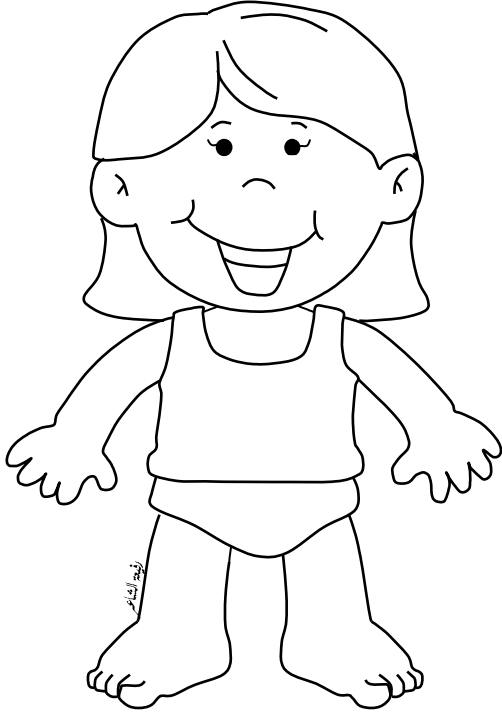

ألون ما ألبسه في يوم ممطر.

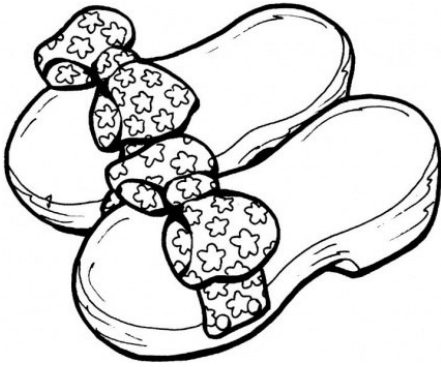
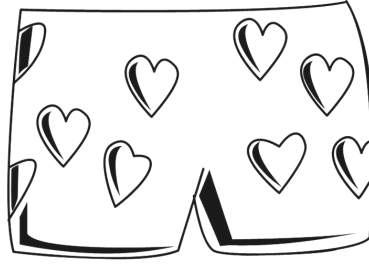
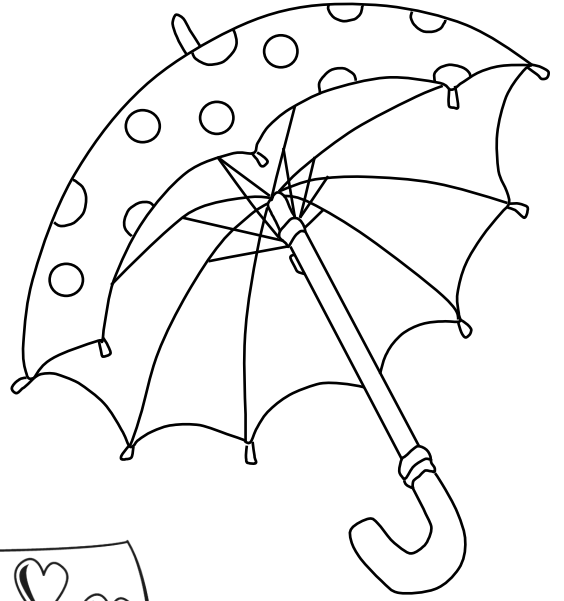
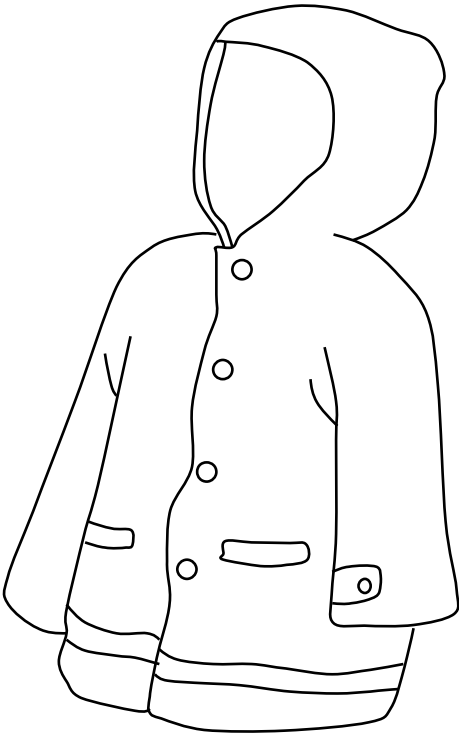
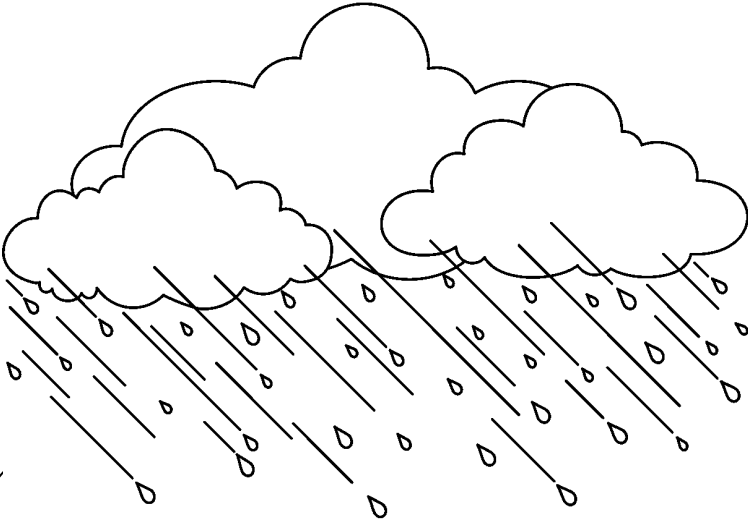



ألون ما ألبسه في يوم مشمس.

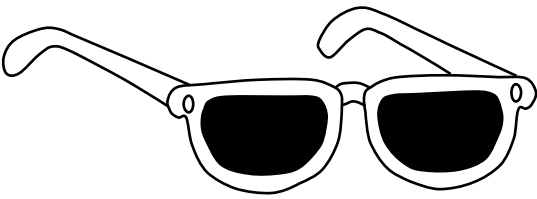
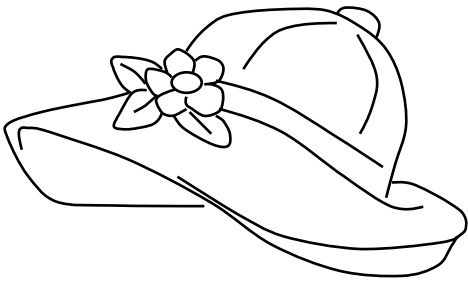
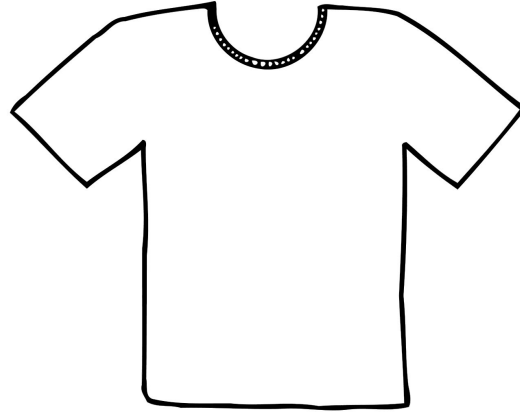
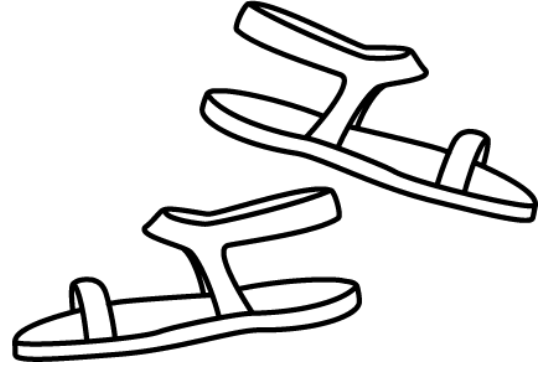
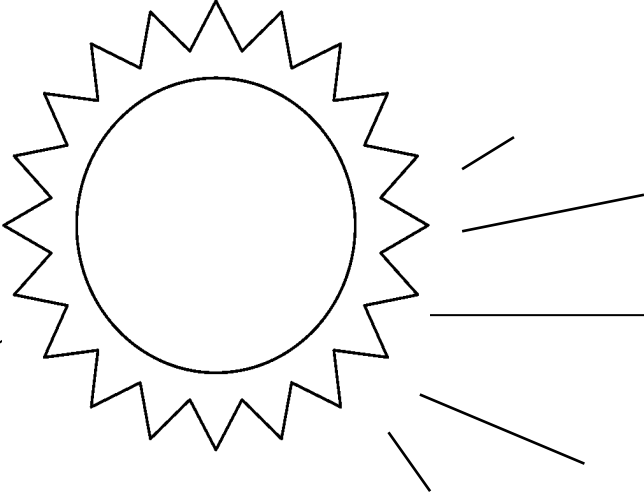



ألون ما ألبسه في يوم بارد.



## ألون أحذيتي.

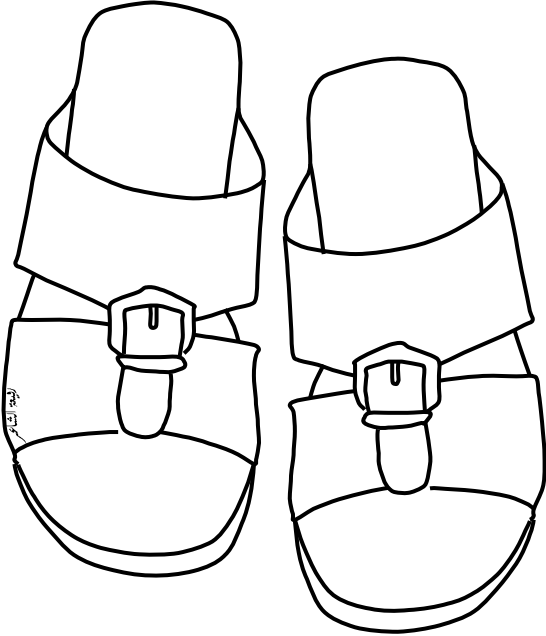
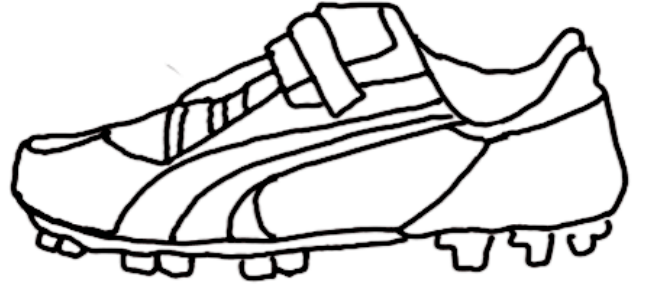
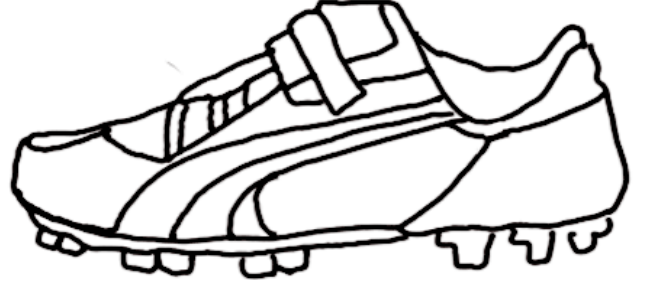
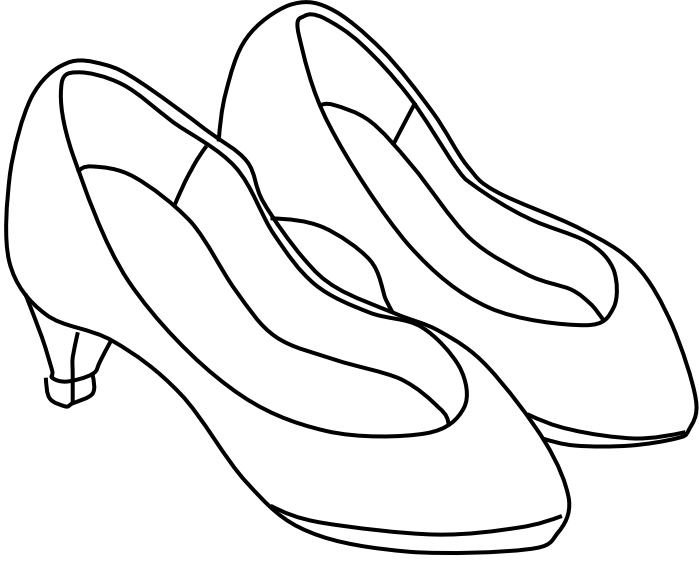

يلون الطالب أحذيته، وتلون الطالبة أحذيتها.





@Arabic\_Books

وحدة

اليوم الوطني



ألون اسم بلادي الإمارات.

الإمارات

الإمارات

عمان

العراق

الإمارات

الكويت



الإمارات

قطر



أتعرف على حكام الإمارات . أطابق وأصل.



خليفة بن زايد آل نهيان

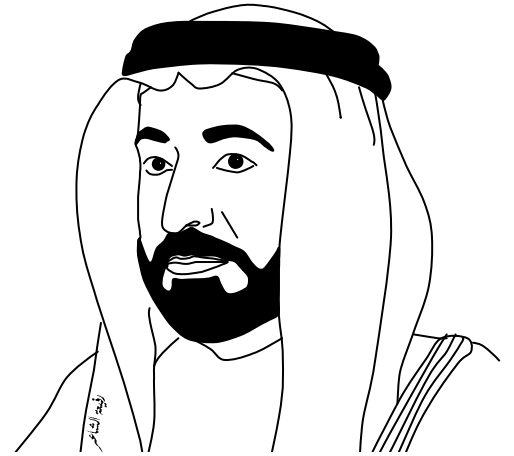

سلطان بن محمد القاسمي



محمد بن راشد آل مكتوم



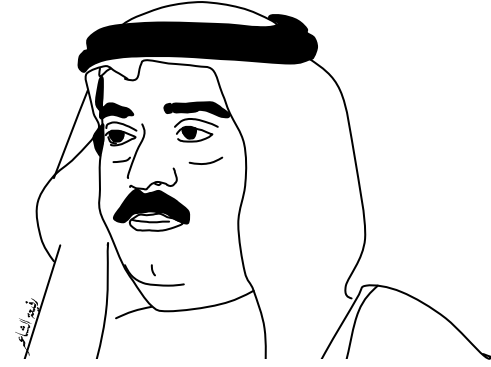
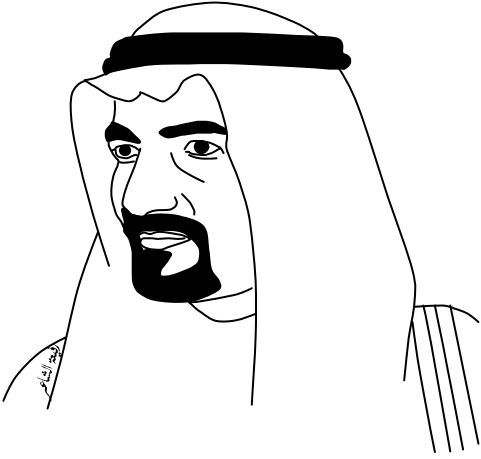

سعود بن راشد المعلا

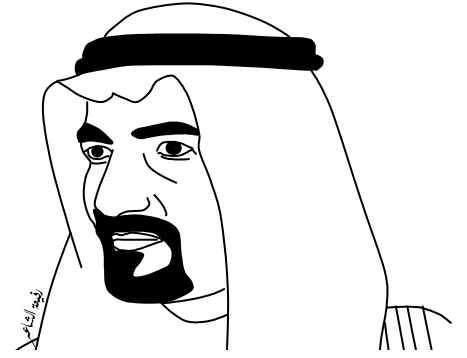

حمد بن محمد الشرقي

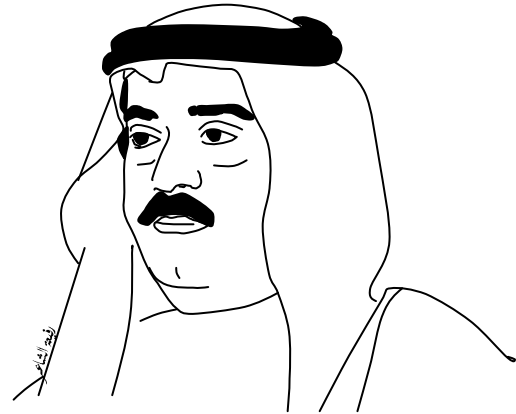

حميد بن راشد النعيمي



سعود بن صقر القاسمي



## ألون علم بلادي.

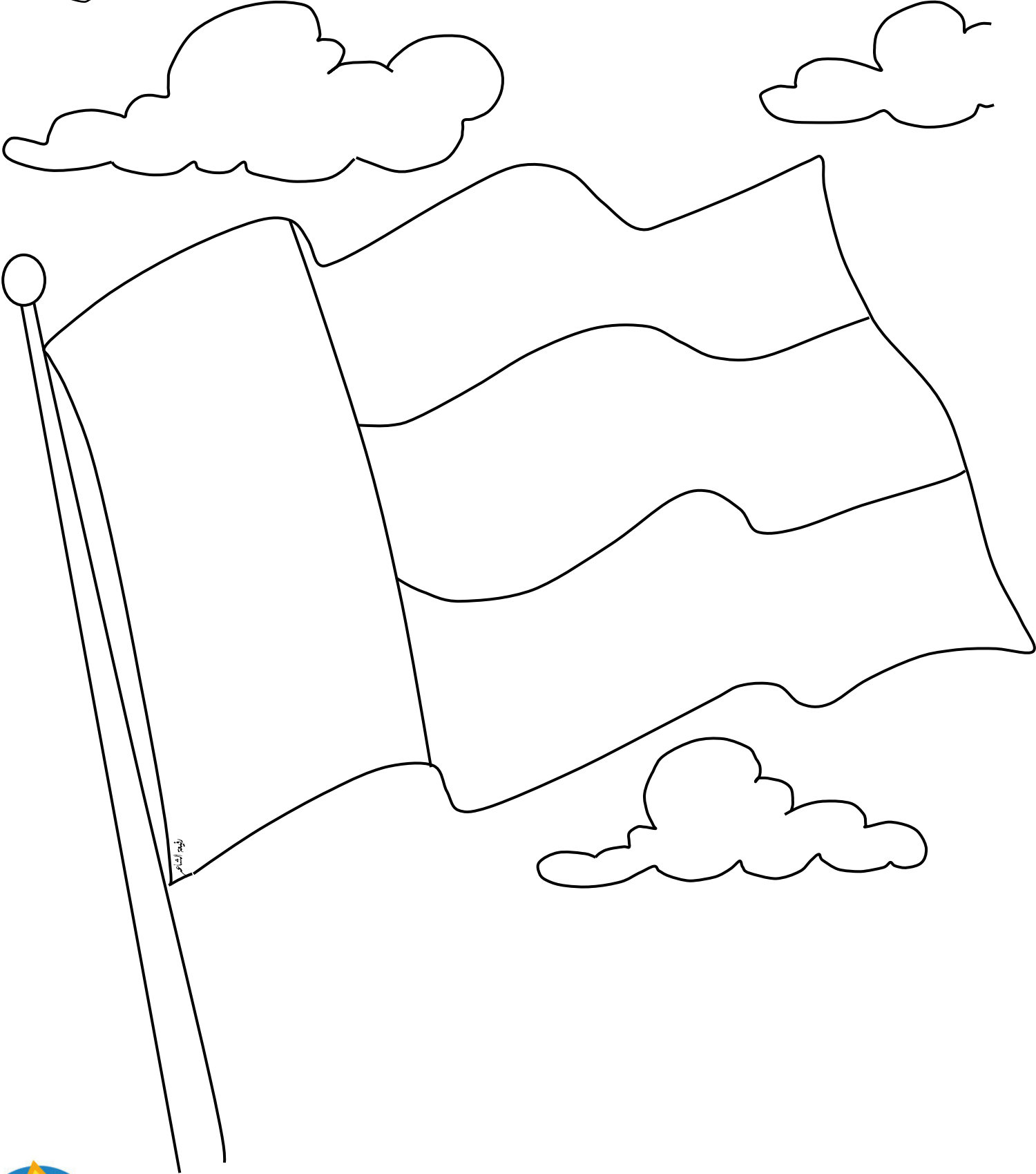
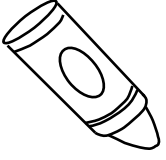

أطابق أسماء الإمارات السبع، أصل.

أم القيوين

رأس الخيمة

دبي

دبي

رأس الخيمة

أبوظبي

الشارقة

أم القيوين

أبوظبي

الفجيرة

عجمان

عجمان

الفجيرة

الشارقة





## أحوط مظاهر الاحتفال باليوم الوطني.

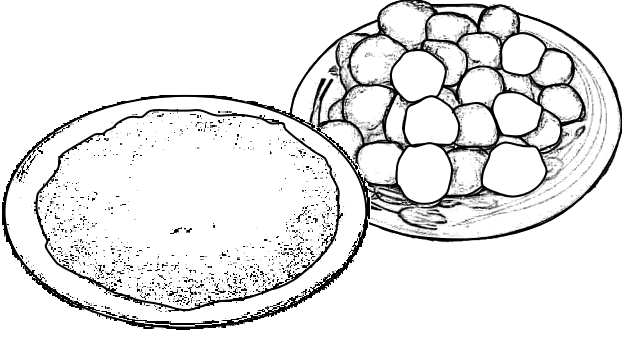

إعداد الأكلات الشعبية



الرقصات التراثية

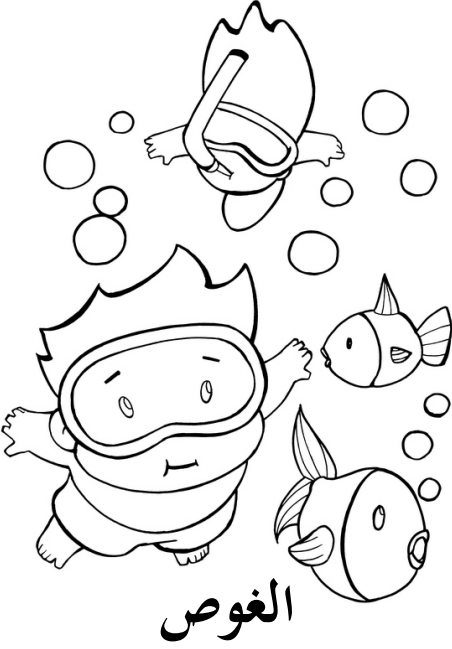

الغوص

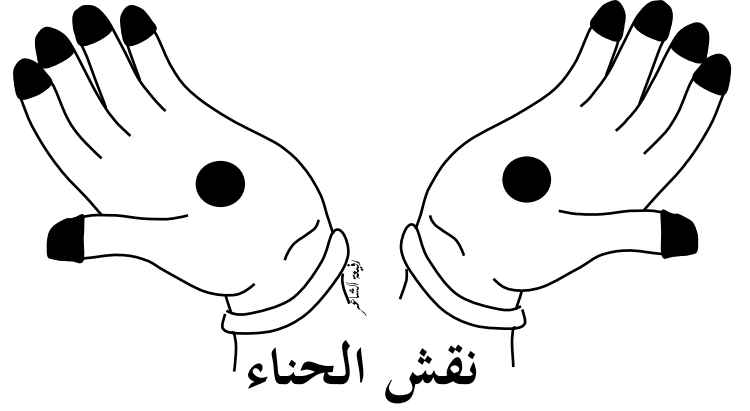

نقش الحناء



لبس الملابس التقليدية



لعب كرة القدم





@Arabic\_Books

وحدة

الطعام والشراب



أحوّط مجموعة الطعام بدائرة ومجموعة الشراب بدائرة أخرى.

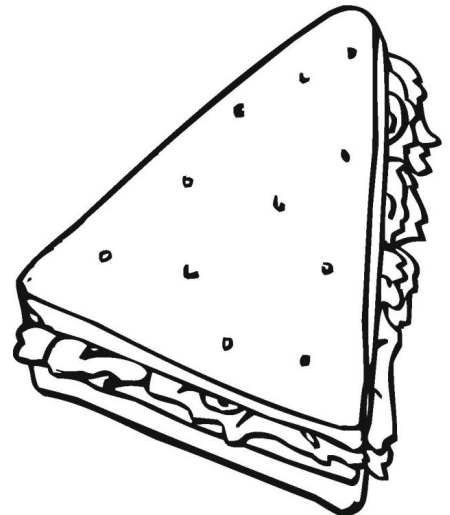
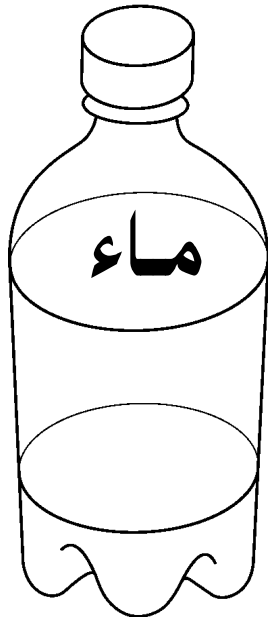
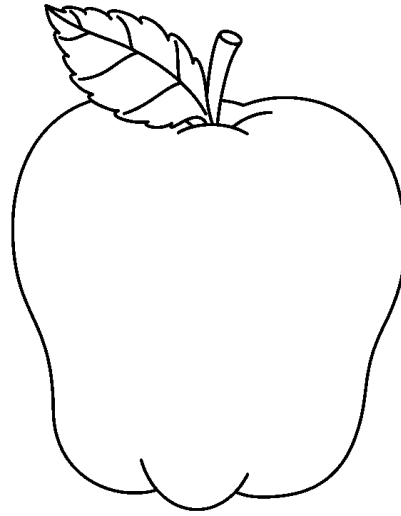
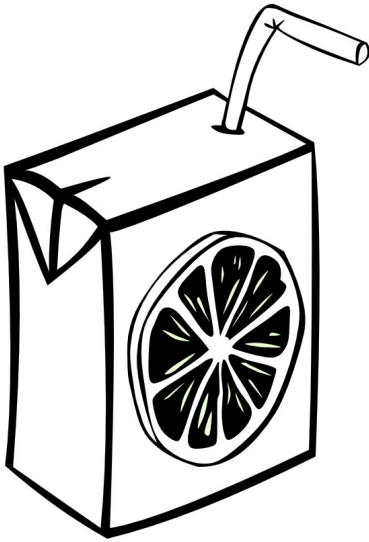
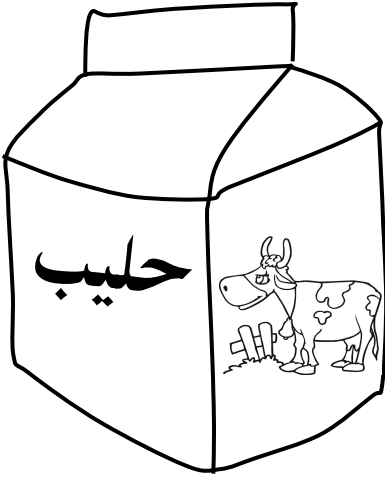

أصل الطعام بمكان شراءه.

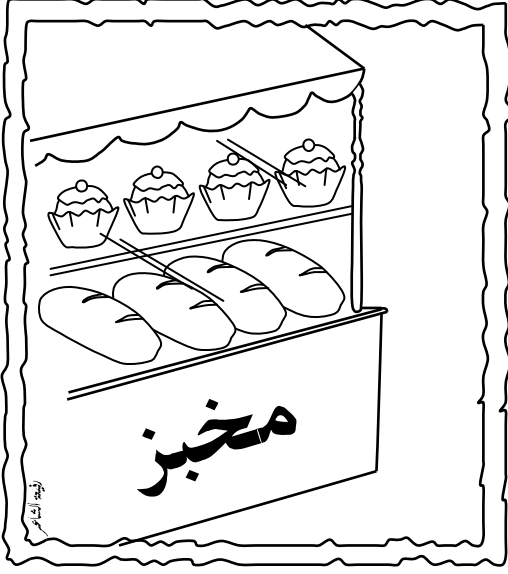

خضروات

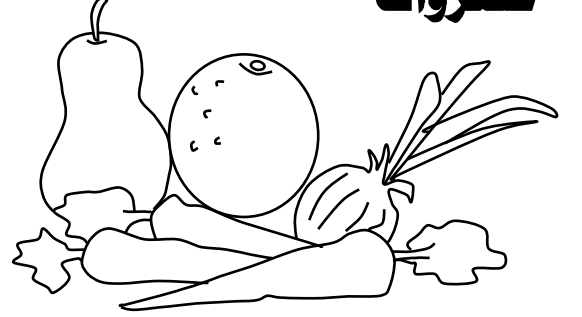

سمك

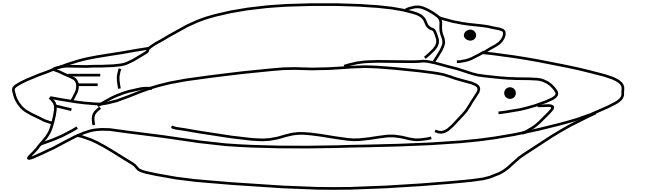

معجنات



## ألون الخضروات.

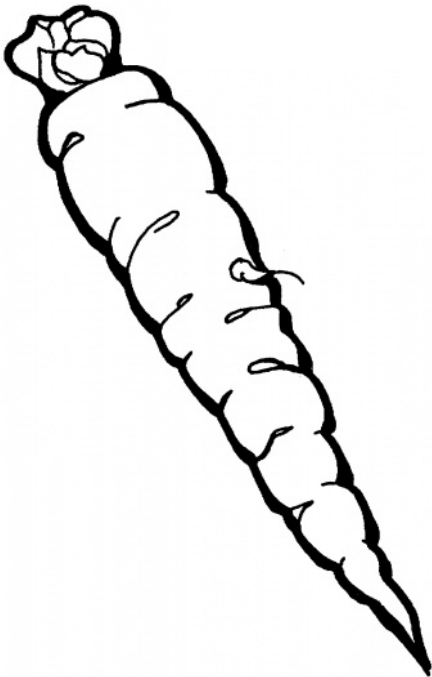
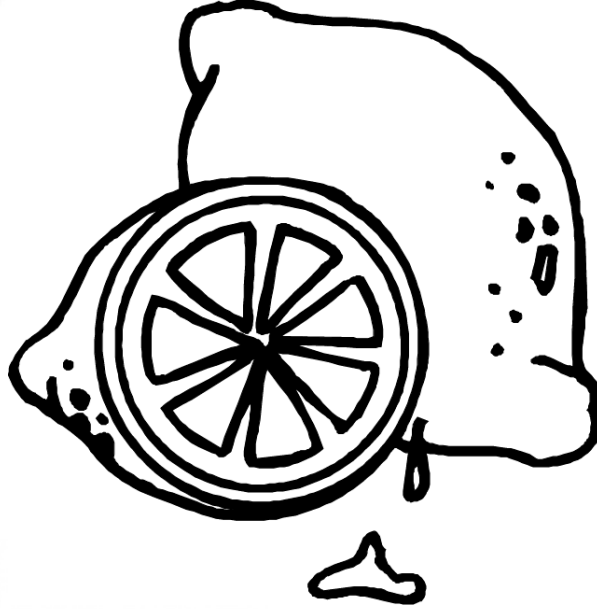
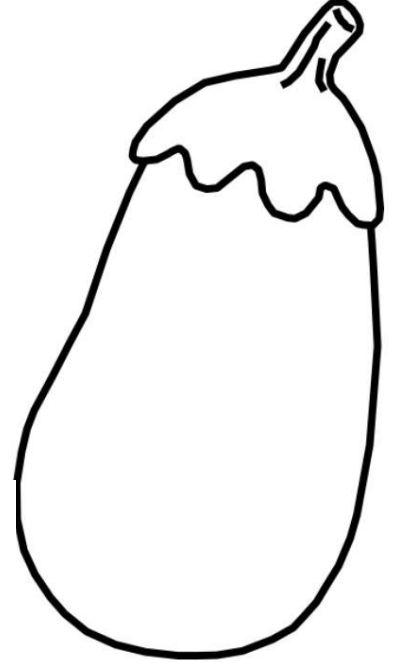
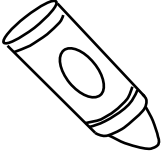

بعض طعامنا من منتجات الحيوان ، أصل.

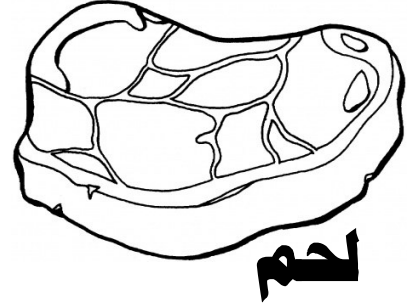
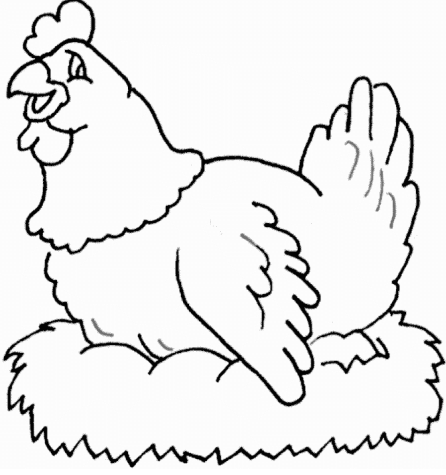

لحم

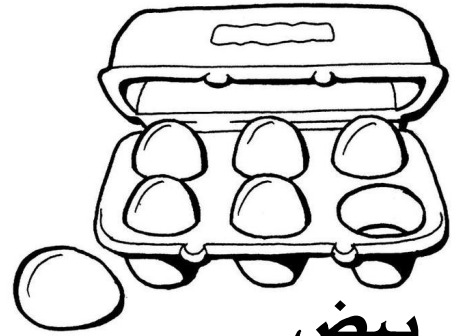

بيض

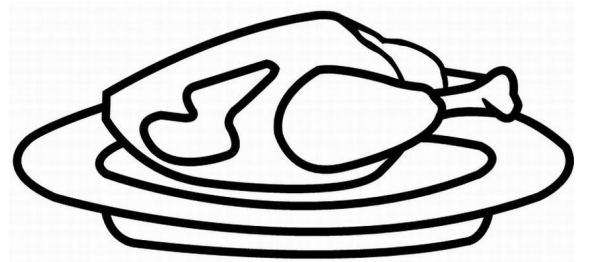
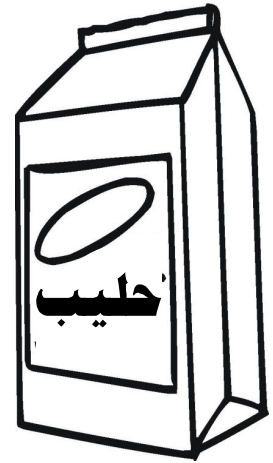
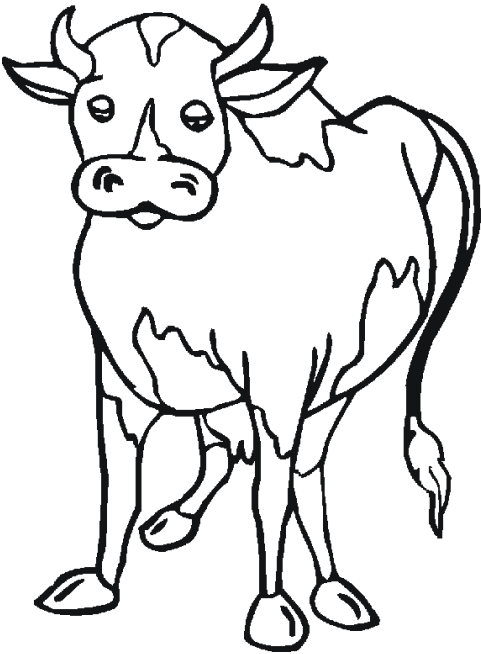

دجاج



" أكثر ، أقل " أحوٲ الأكثر.

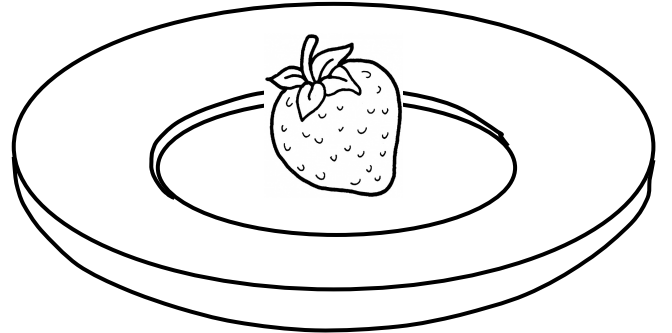
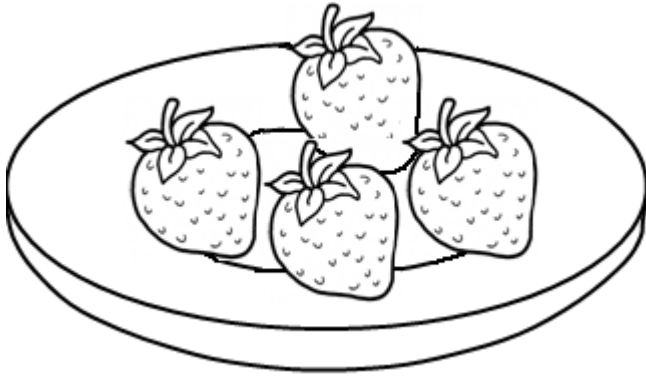
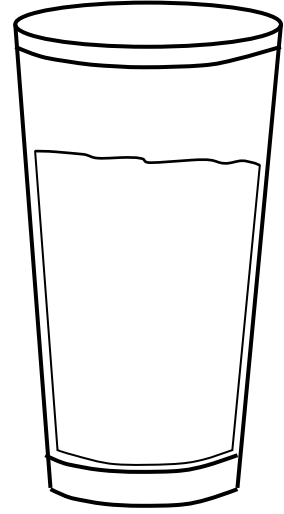
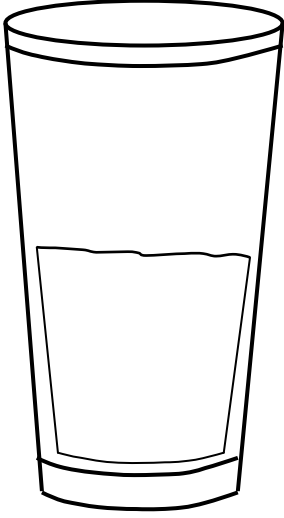



@Arabic\_Books

وحدة

الحيوانات





## مساكن الحيوانات، أصل الحيوان بمسكنه.

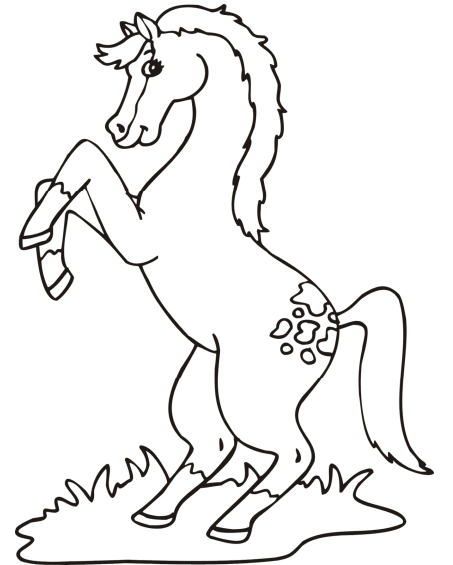
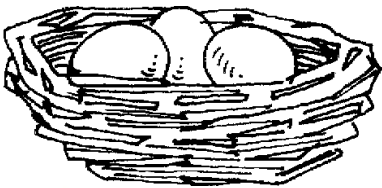
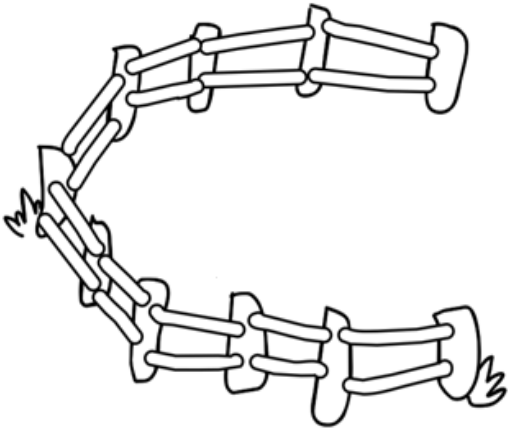
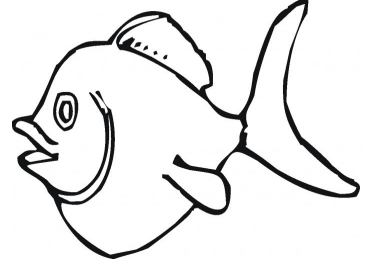
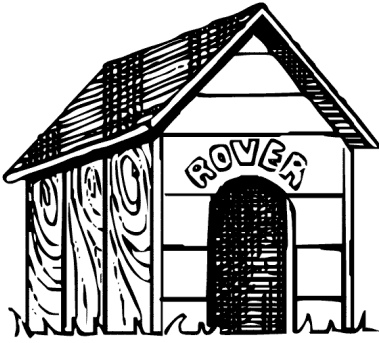
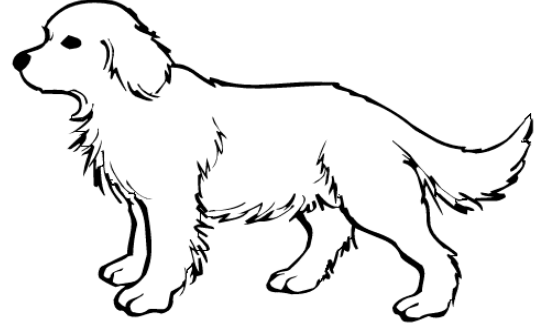

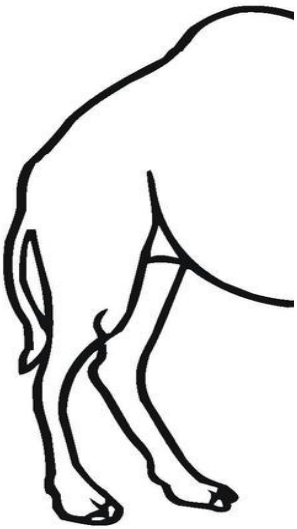
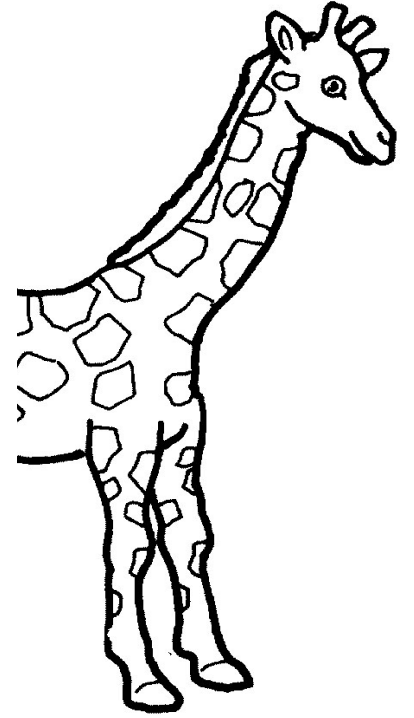
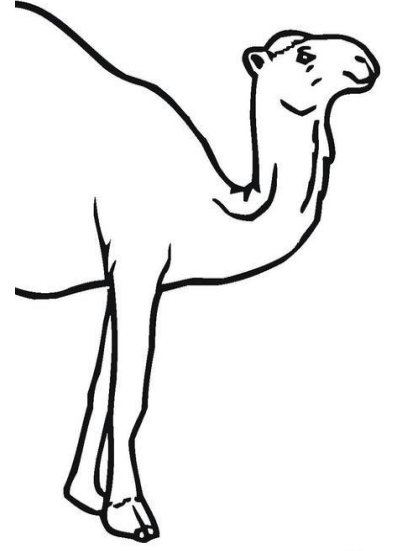
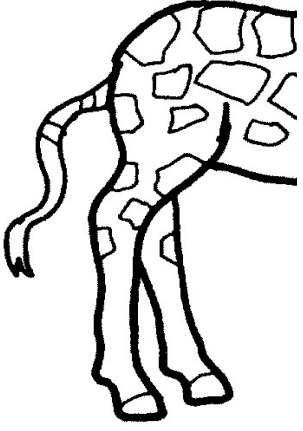

## ألون حيواني المفضل.

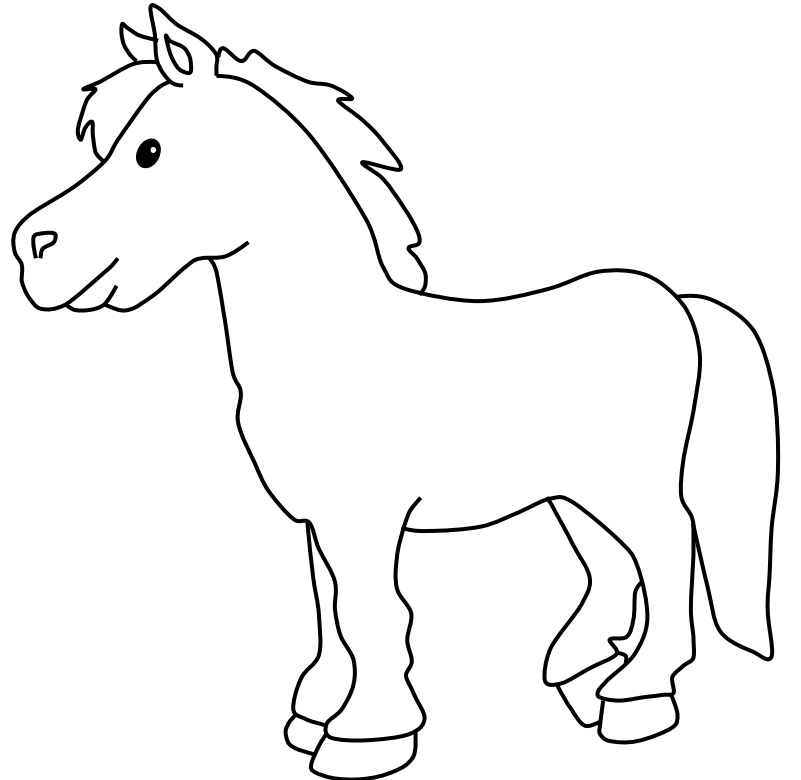
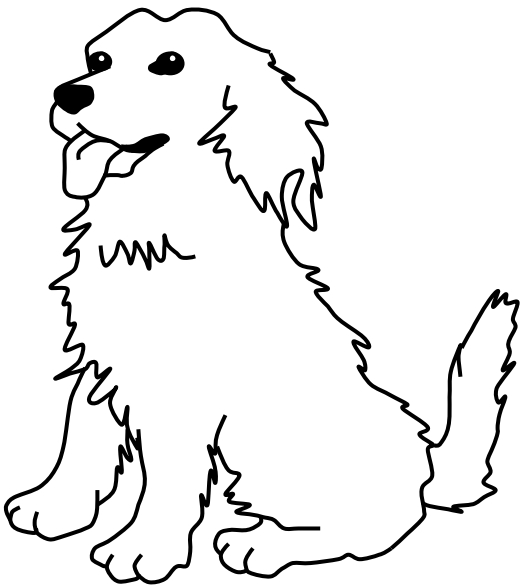
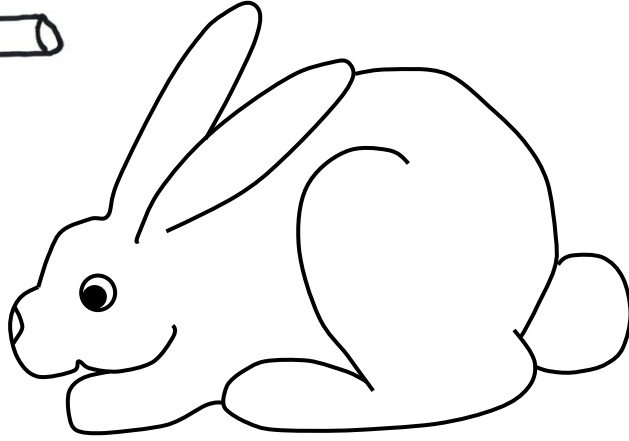
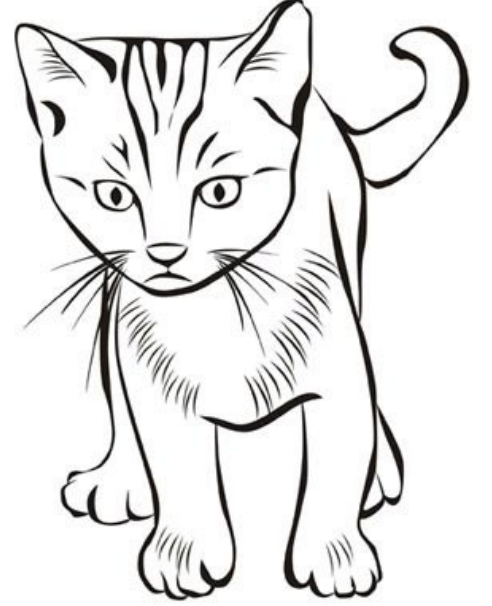
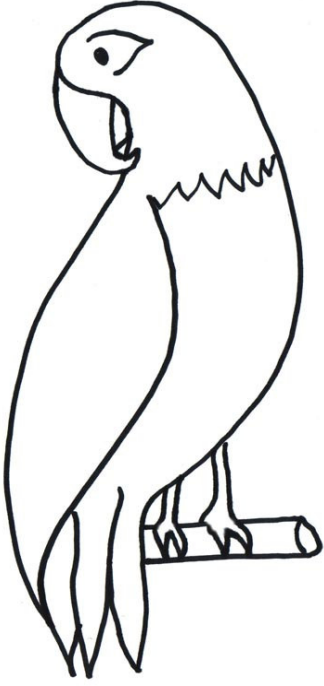



طعام الحيوانات، أصل الحيوان إلى طعامه.



خضار

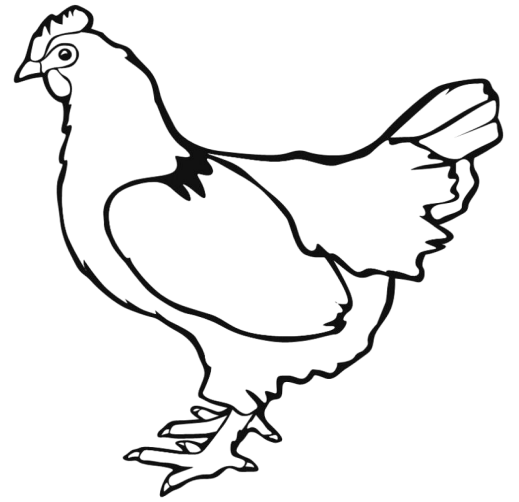

عشب

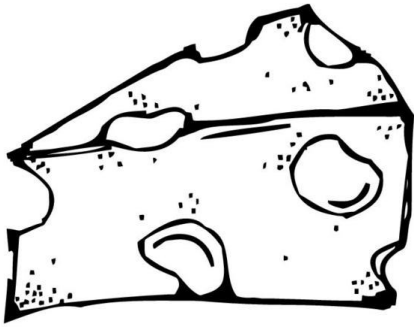

جبين

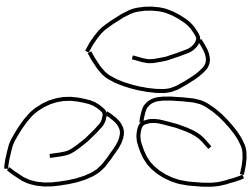
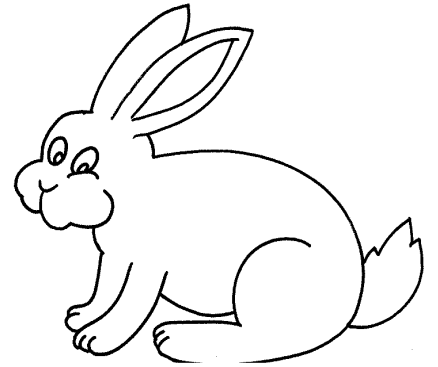

شعير

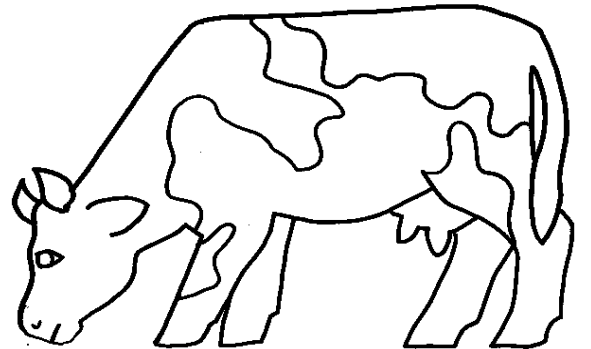

أرسم علامة **X** على السلوك الخاطئ في التعامل مع الحيوانات.

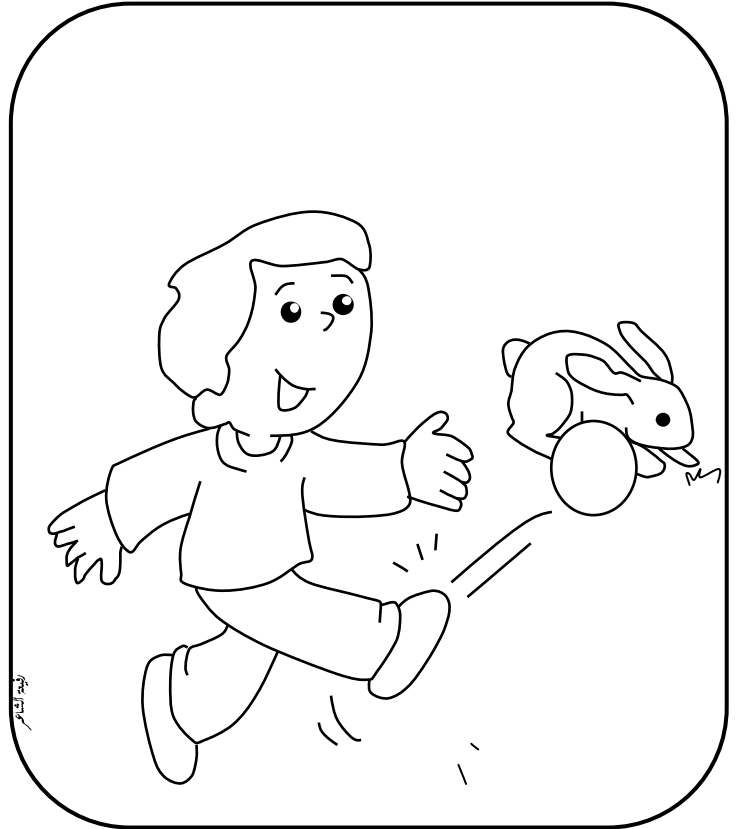
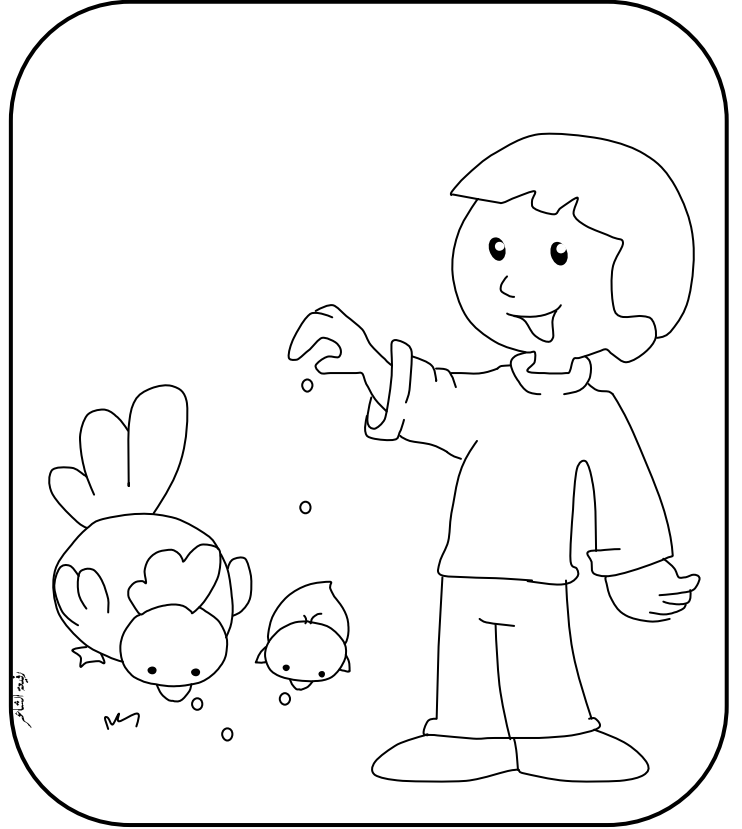

## عائلة الحيوانات ، أصل الحيوان إلى صغيره.

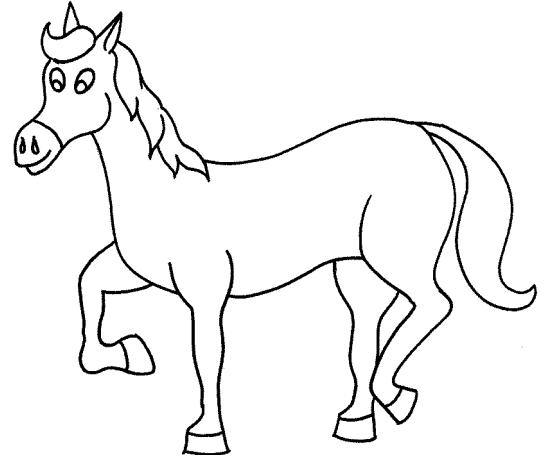
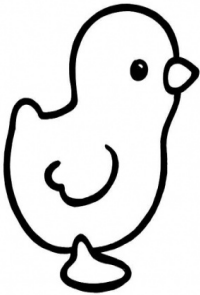
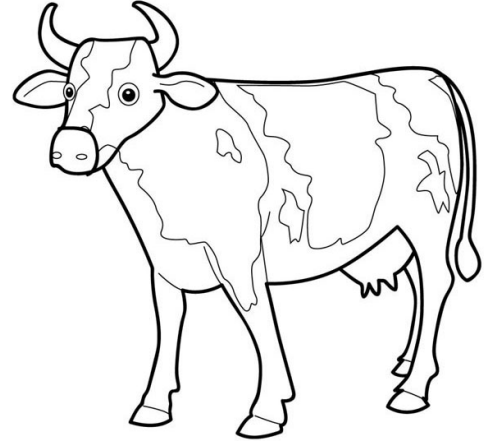
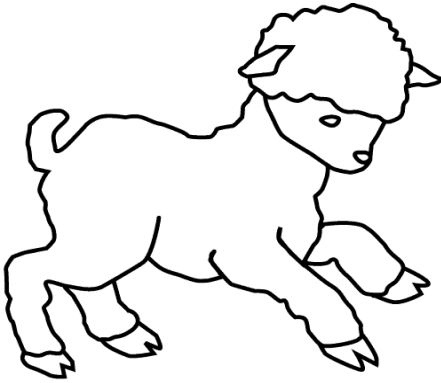
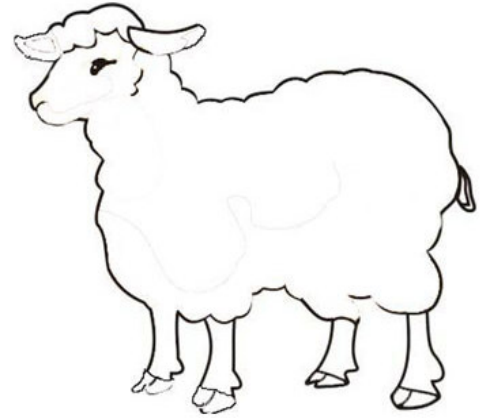
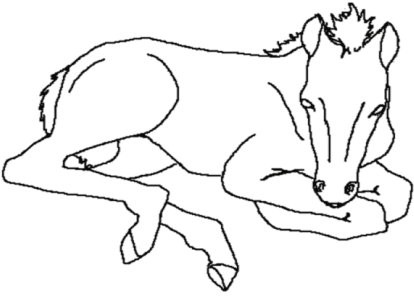
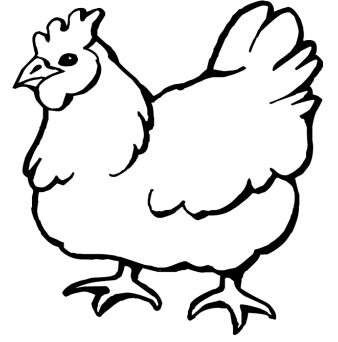
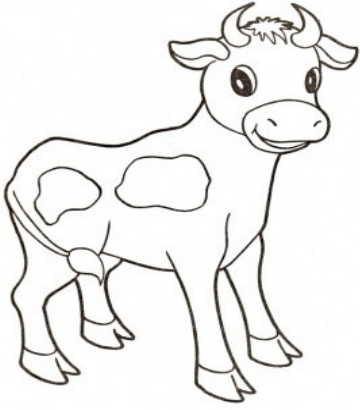

## الحيوانات مختلفة، أصل الحيوانات بأجزائها.

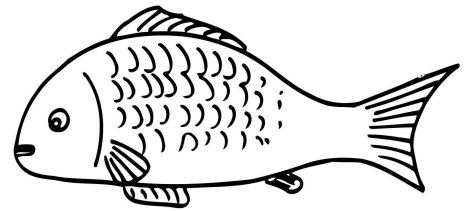
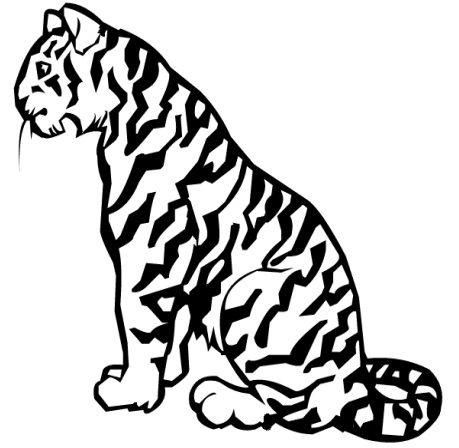
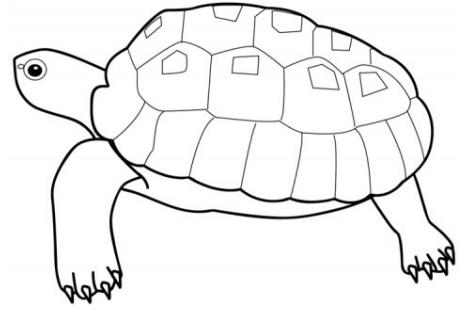
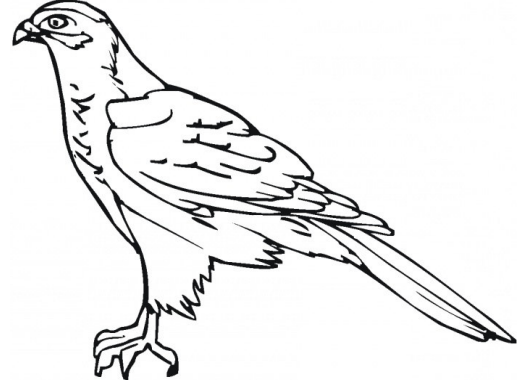
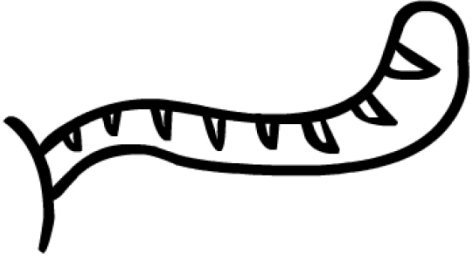



@Arabic\_Books

وبدة

الصحراء





أتعرف على حيوانات الصحراء ، أقرأ و ألون.



جربوع

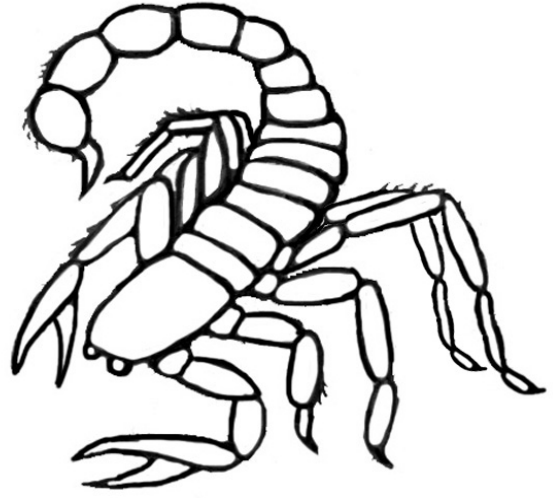

عقرب



سحلية

جمال

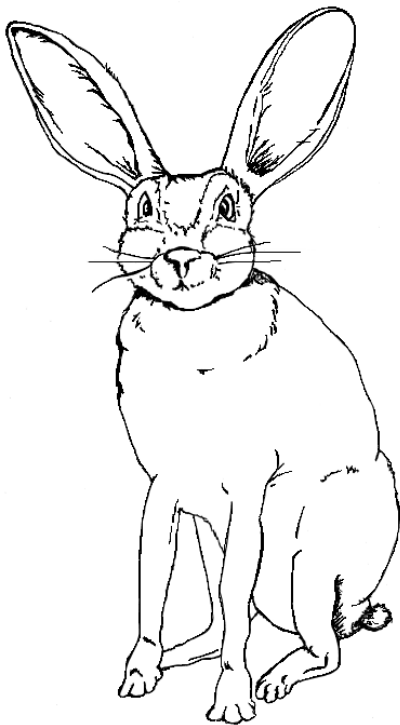

أرنب

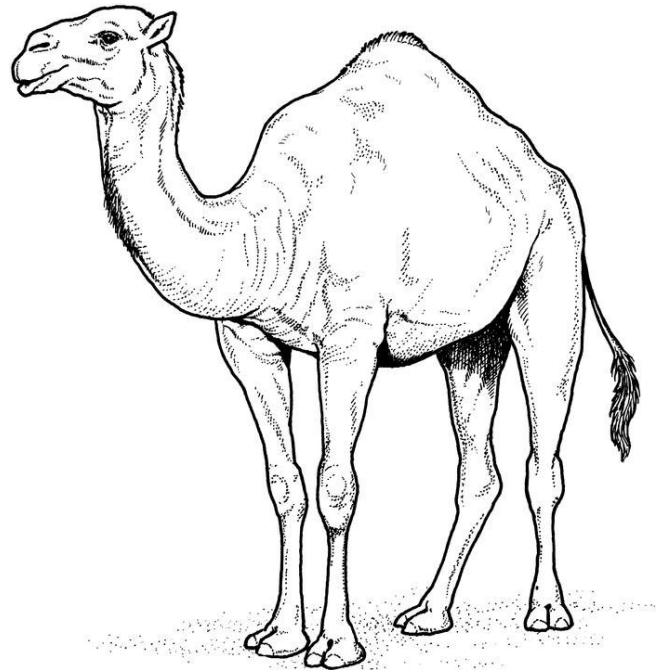

## أحوط محتويات الصحراء.

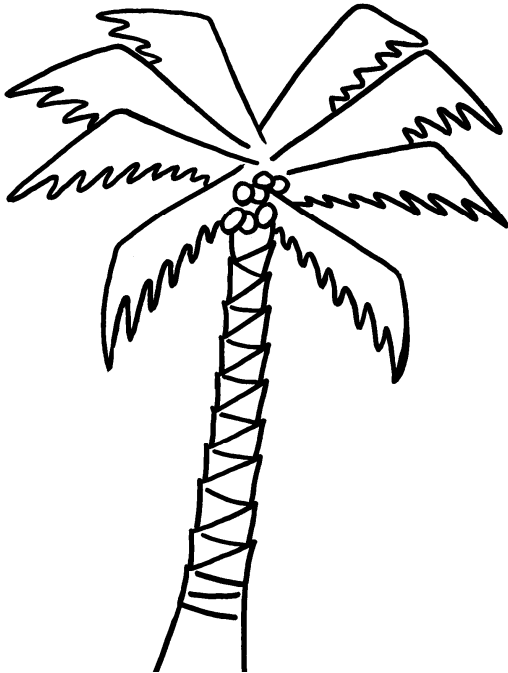
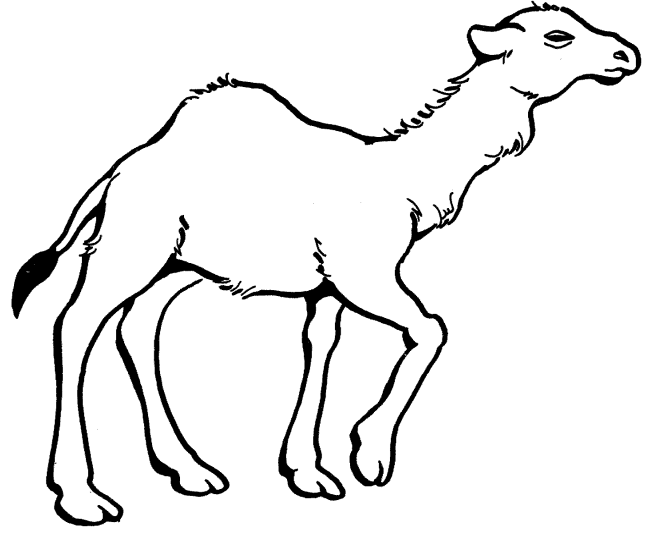
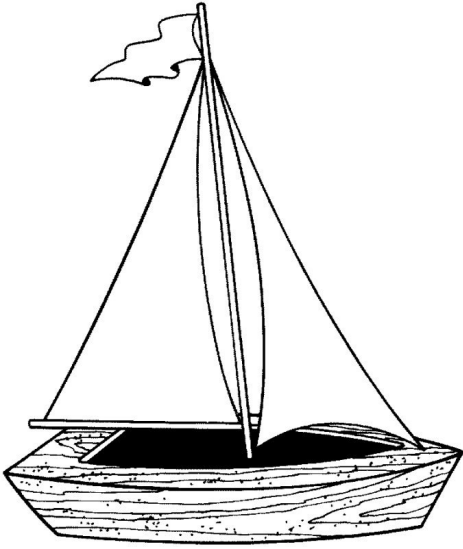
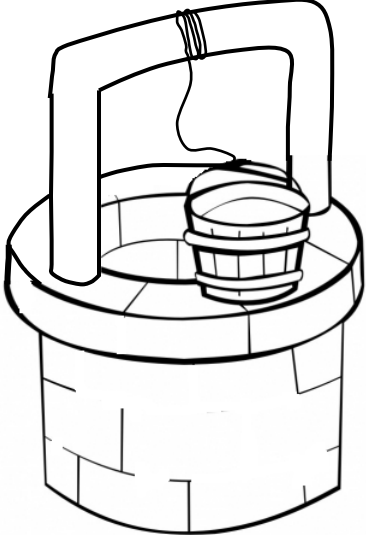

ألون رمل الشاطئ.

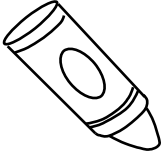

# رمل الشاطئ

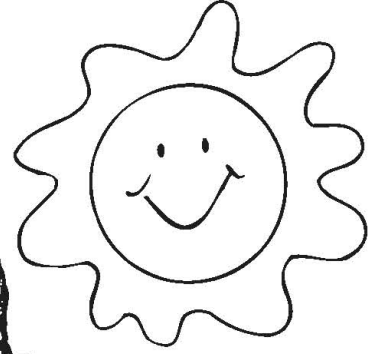

ألون رمل الصحراء.

## رمل الصحراء

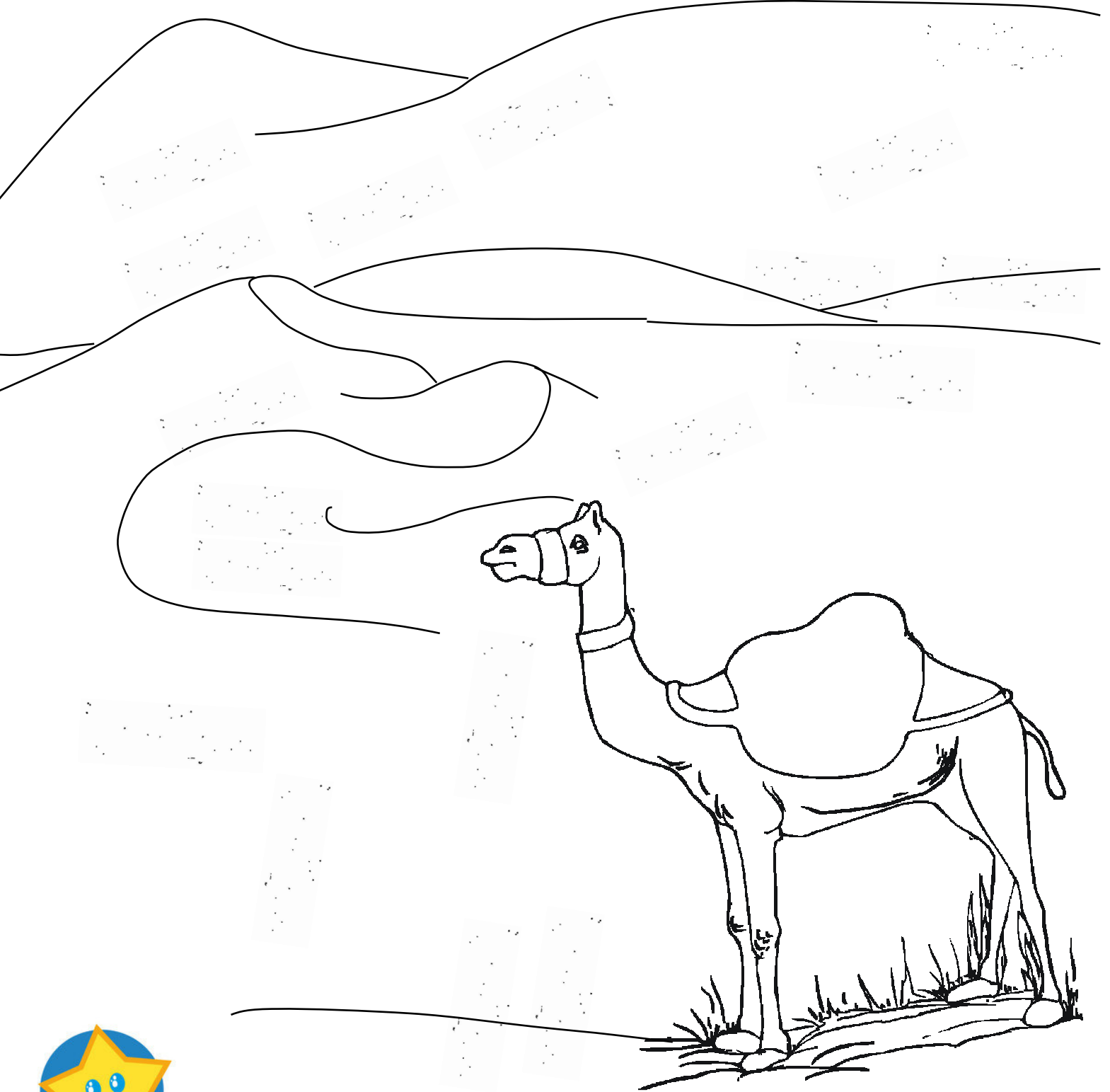

## أطابق الصور وأصل.

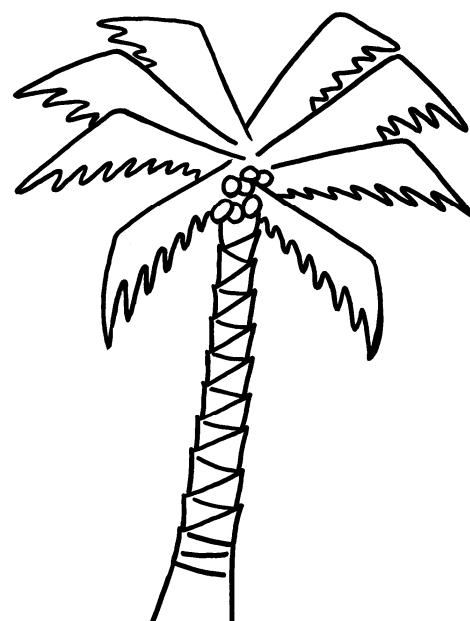
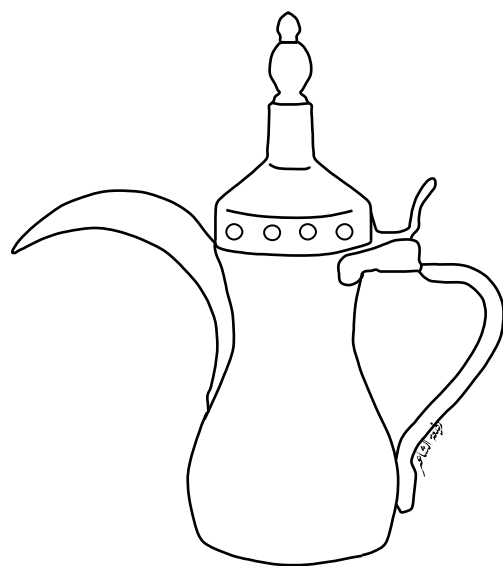

" ثقيل ، خفيف " أحوِّط الشيء الخفيف.



جرّة

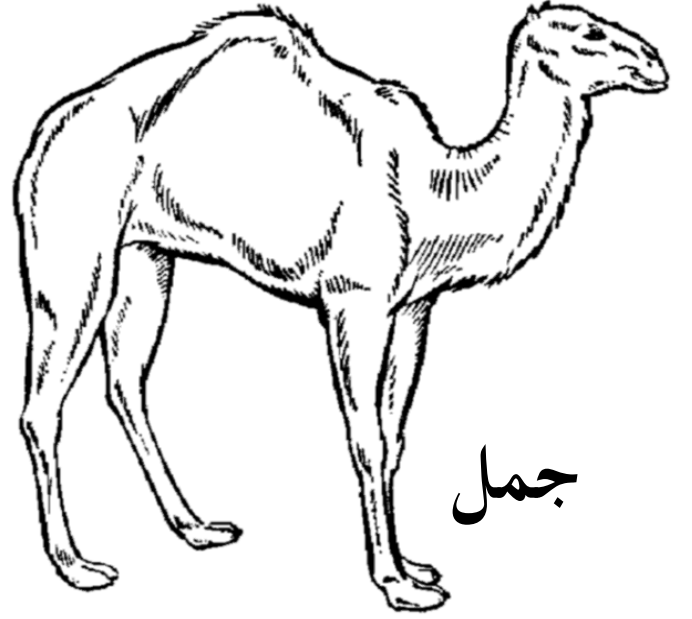

جمل

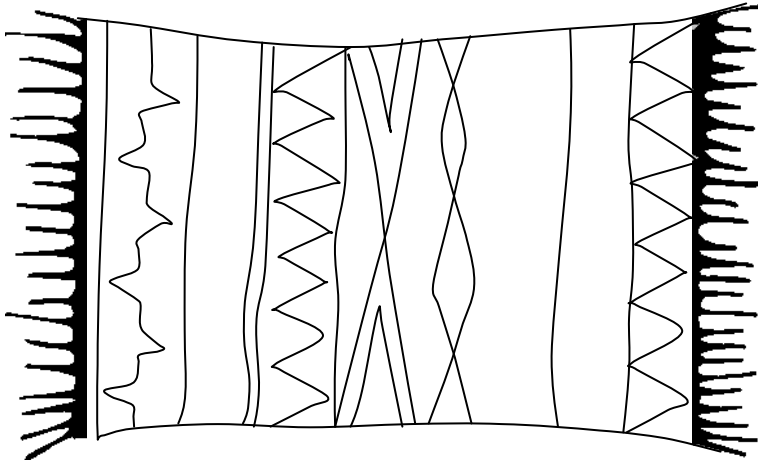

سجادة

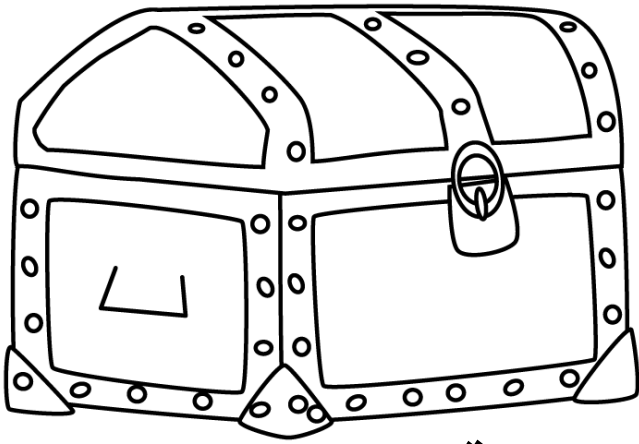

صندوق

رمل

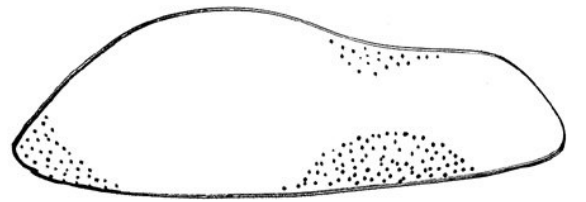



@Arabic\_Books

وحدة

الحج



ملابس الإحرام. ألون.

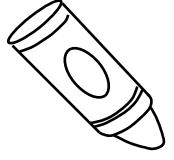

# ملابس الإحرام

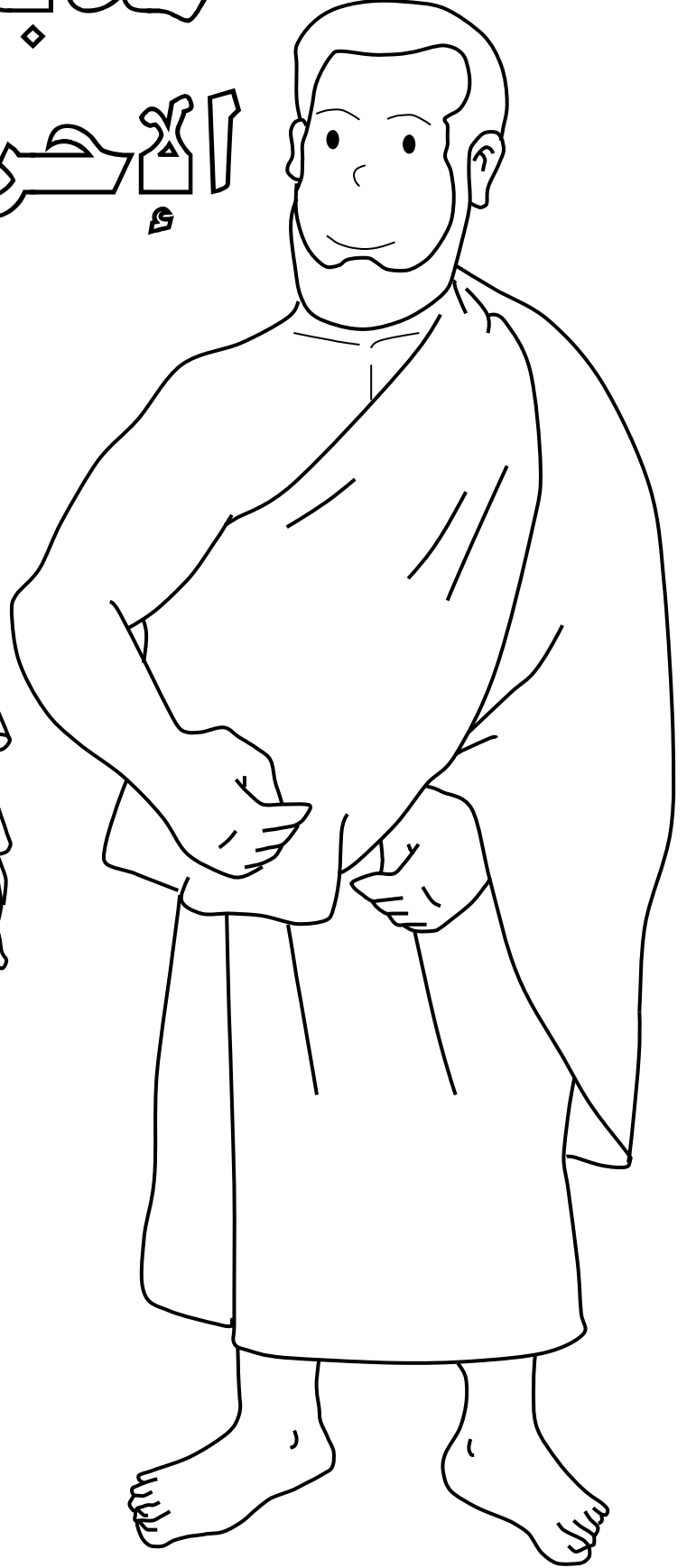
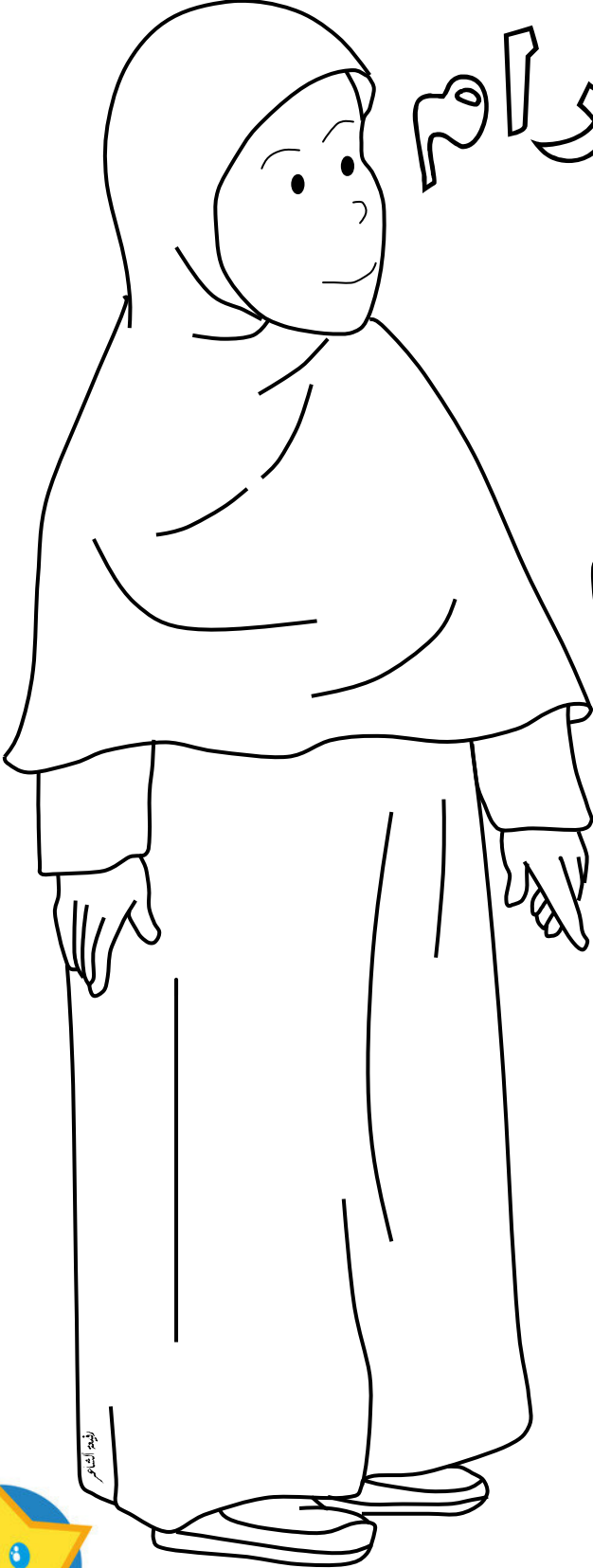



طرق سفر الحجاج. أخطط.

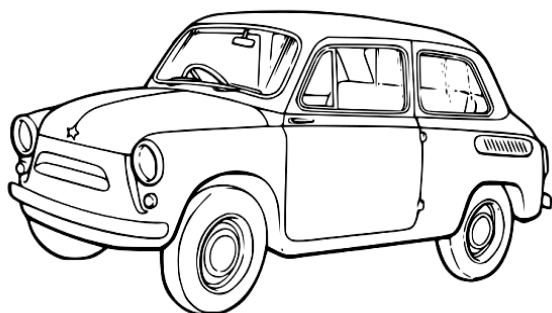
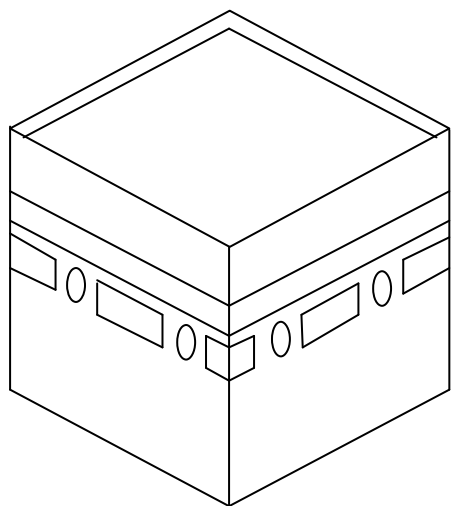
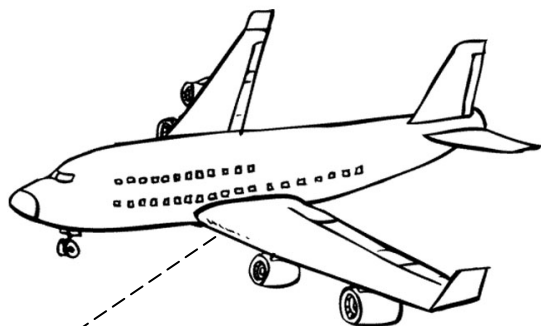

## أحوط هدايا الحجاج.

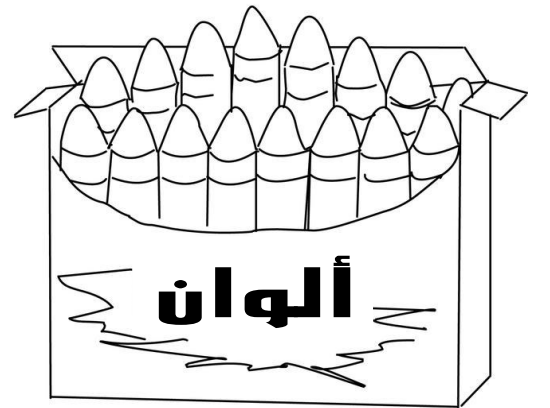
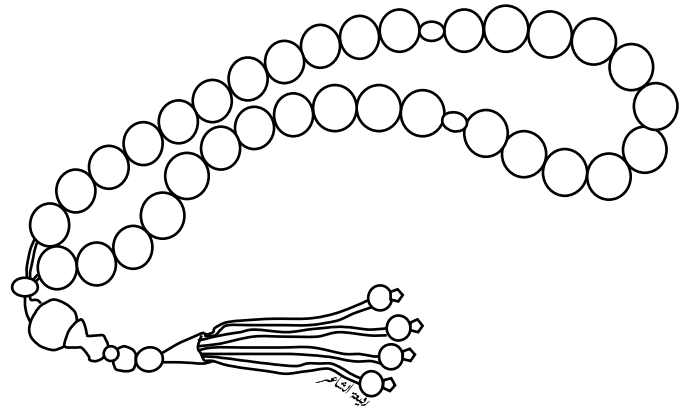
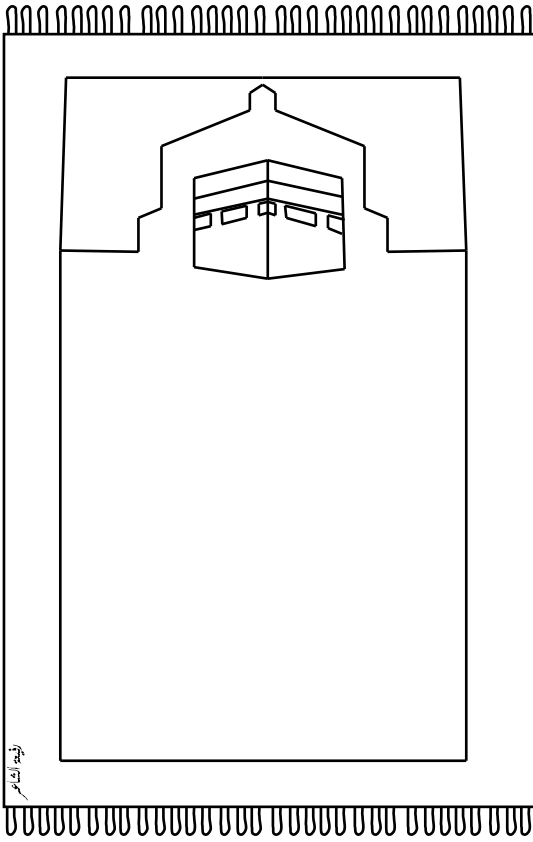
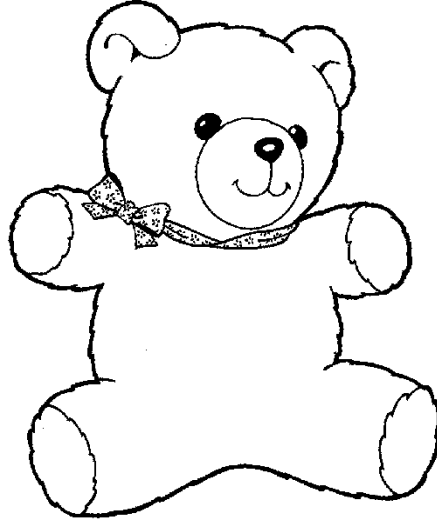
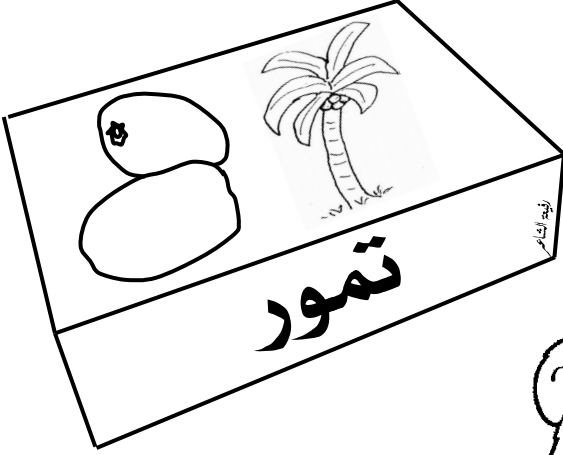



أتعرف على مظاهر الاحتفال بالعيد و ألون.

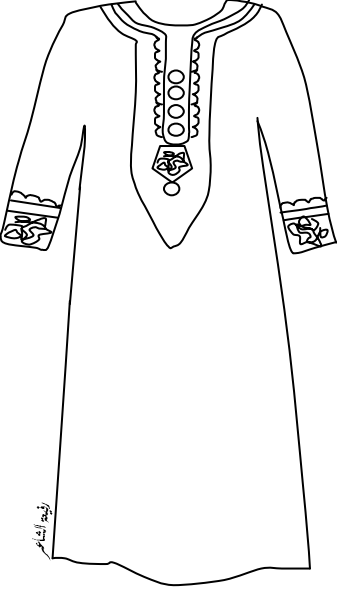

ملابس العيد

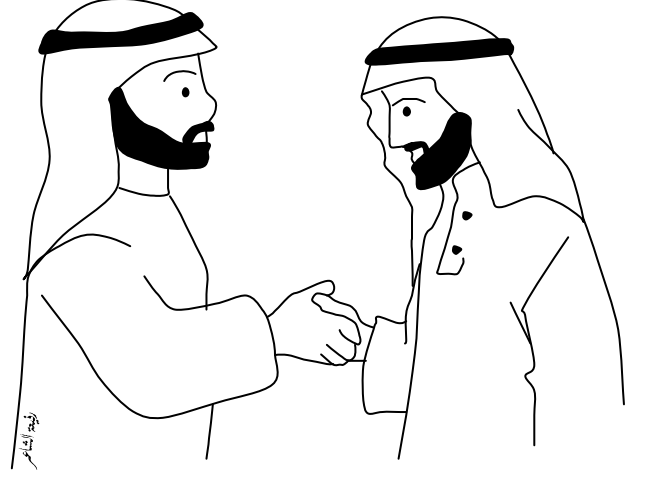

زيارة الأهل والأقارب

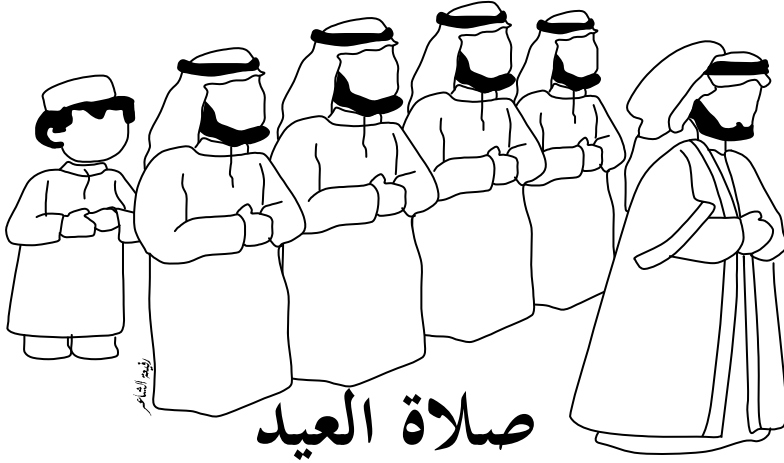

صلاة العيد



الرقصات الشعبية

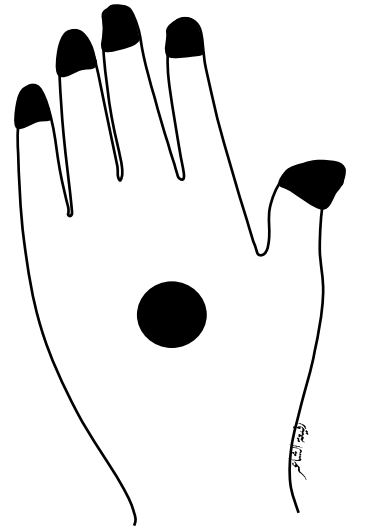

نقش الحنا



## العيد فرحة.

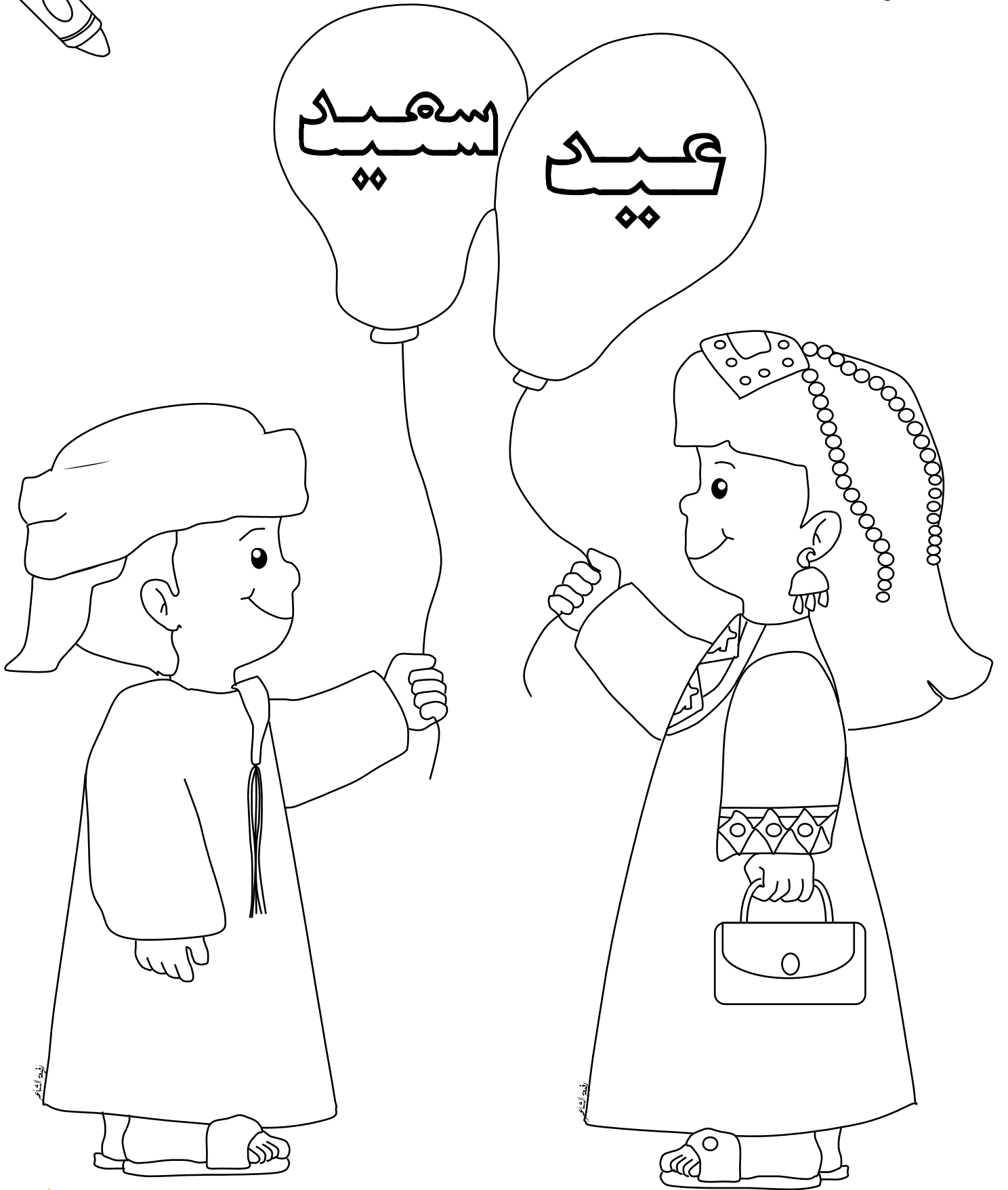
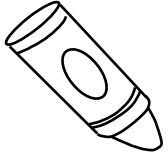

تسلسل الأحجام، أصل الأحجام المتساوية مع بعضها البعض.

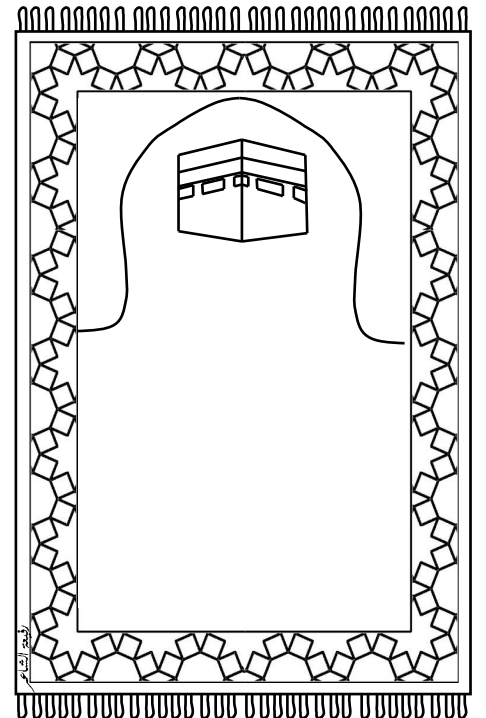
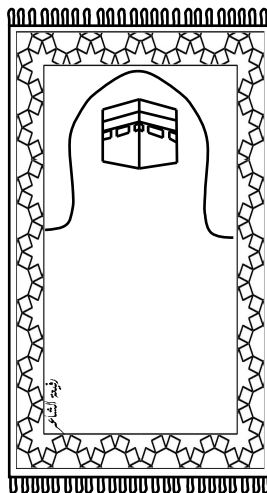
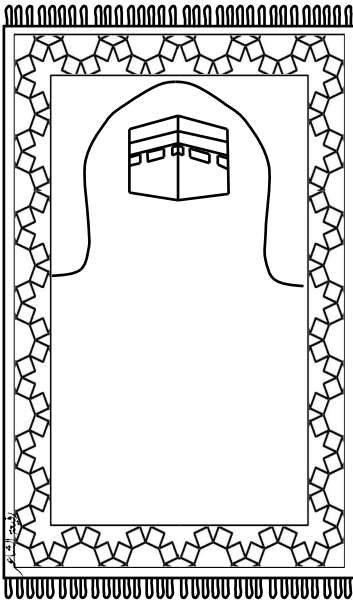
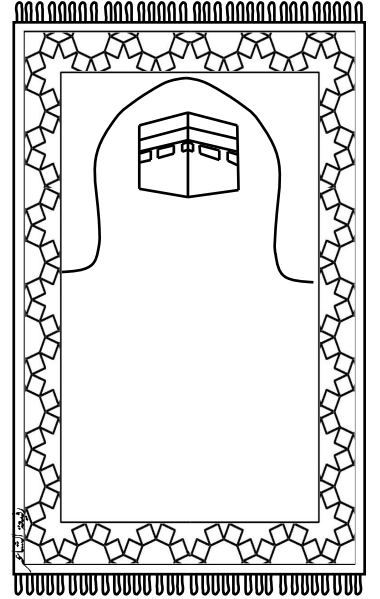
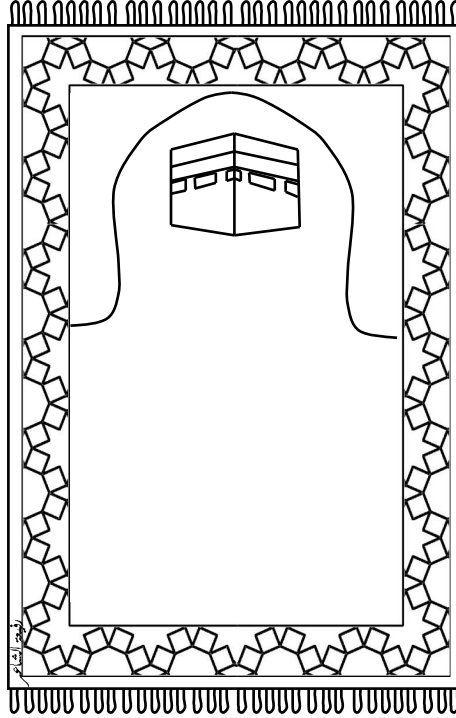
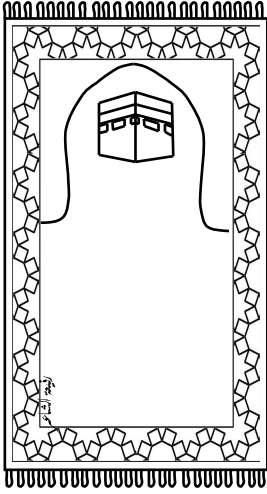



@Arabic\_Books

وحدة

النباتات



أبحث عن صور نباتات والونها.

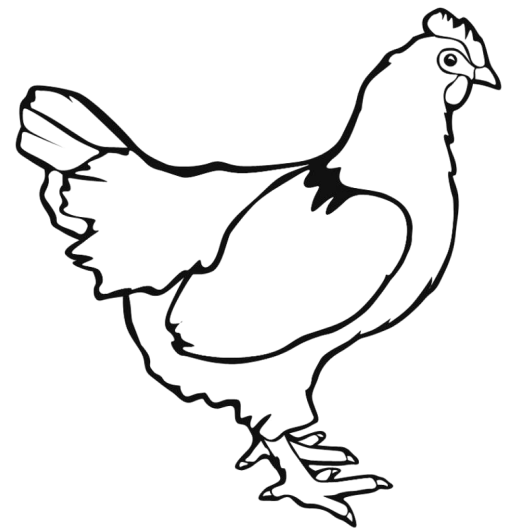
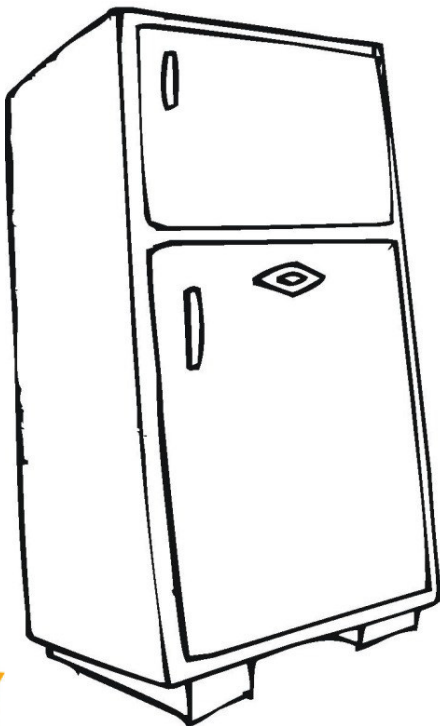
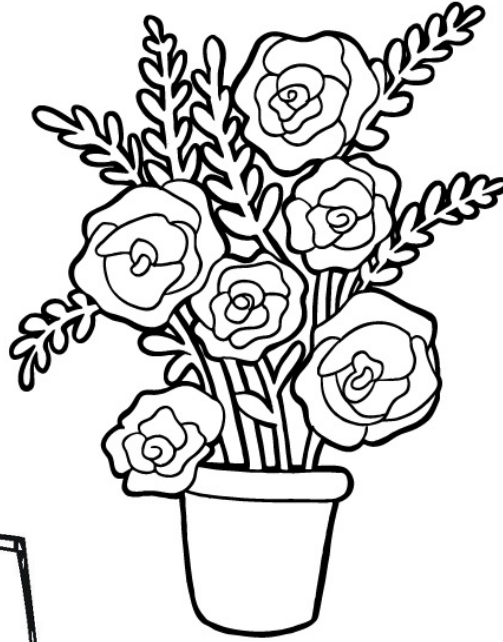
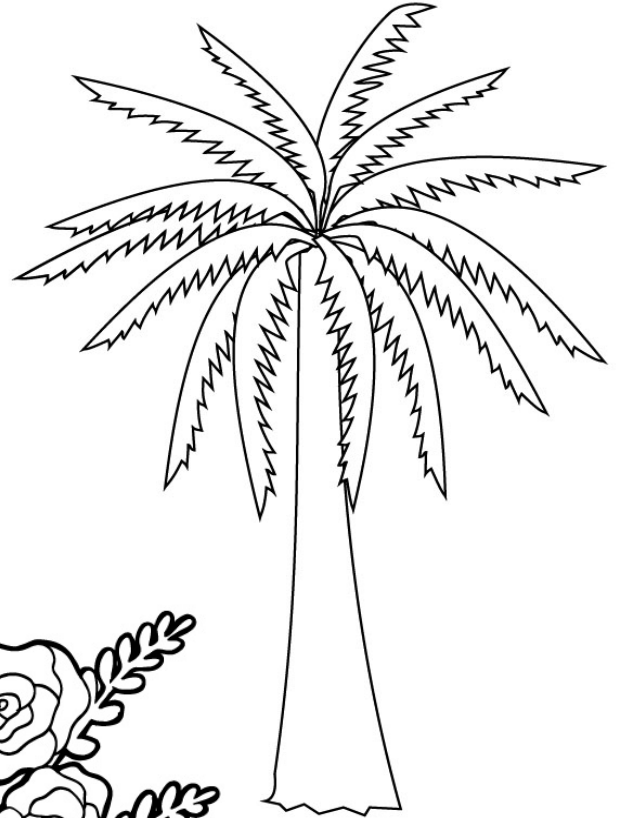
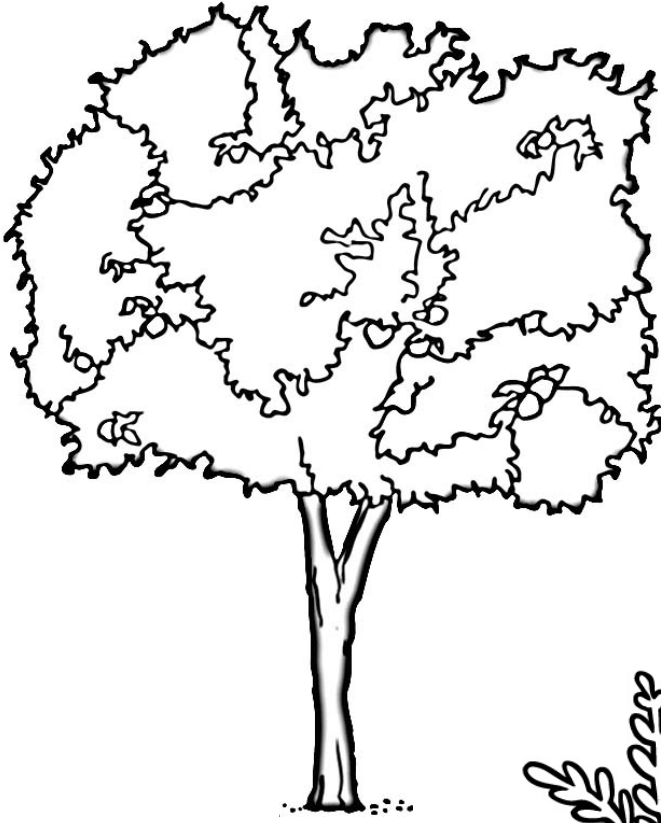

نصنع من النخلة منتجات عديدة، أصل النخلة بمنتجاتها وفوائدها.

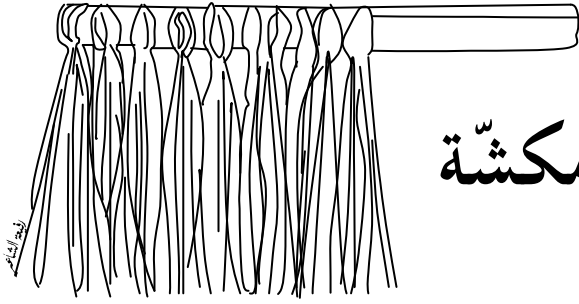

مكشّة

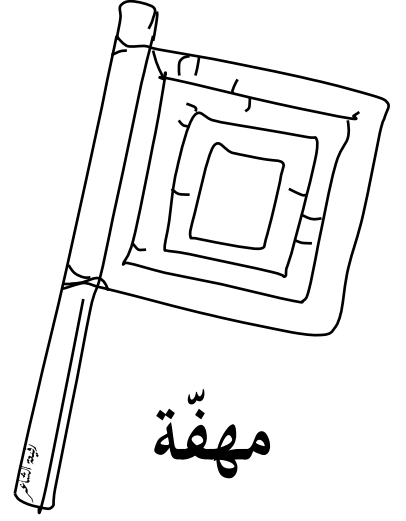

مهفة

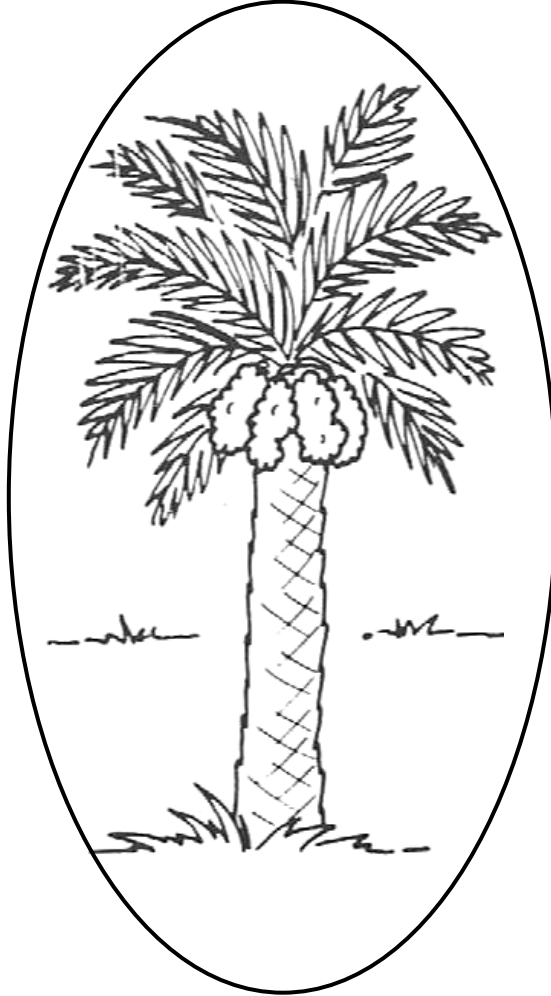

بلح

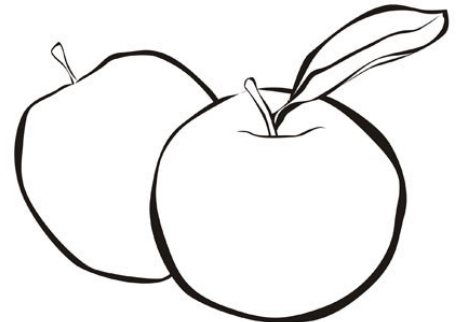
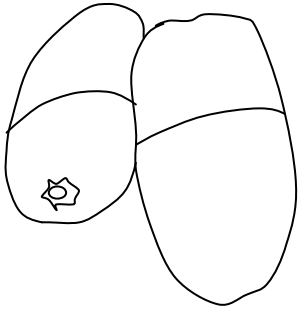

تفاح

أزهار

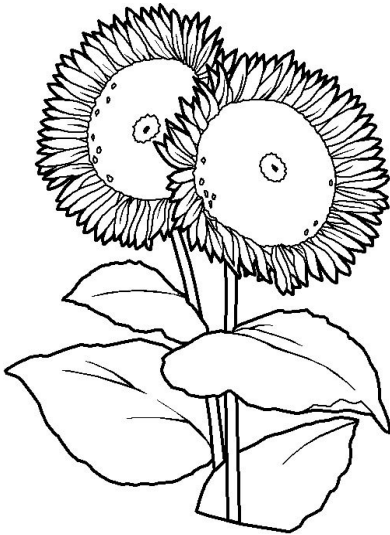

مخرافة





## أوراق النباتات مختلفة، أطابق وأصل.

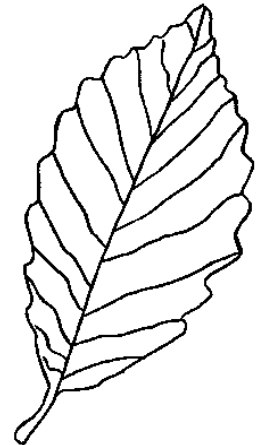
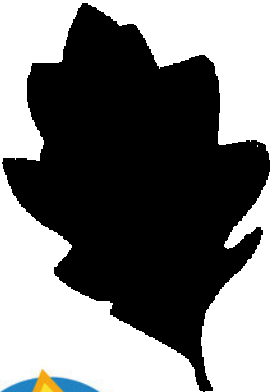
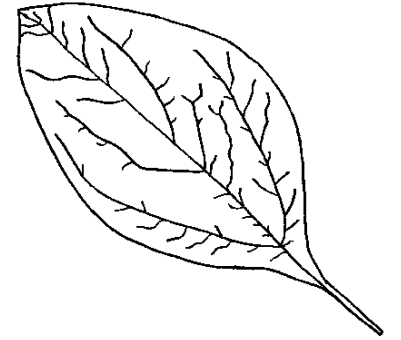
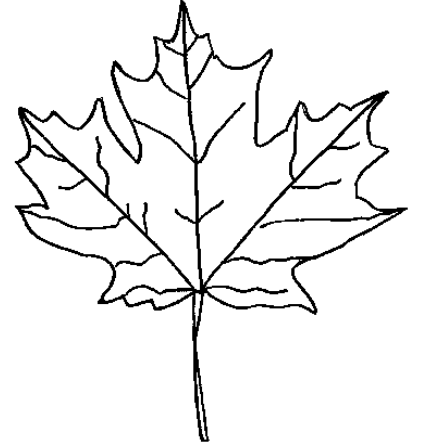
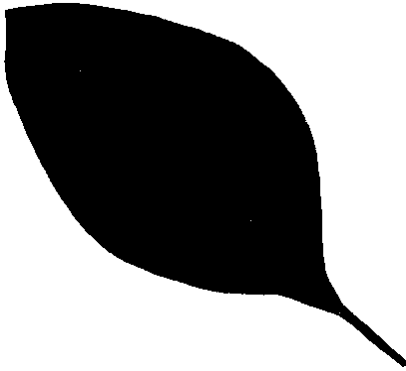
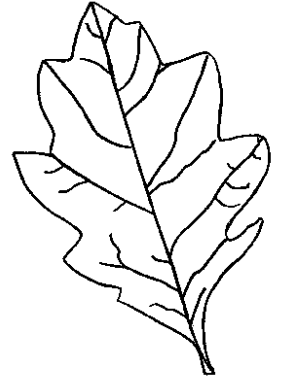

للنباتات بذور، أكتشف بذور بعض الفواكه وألونها.

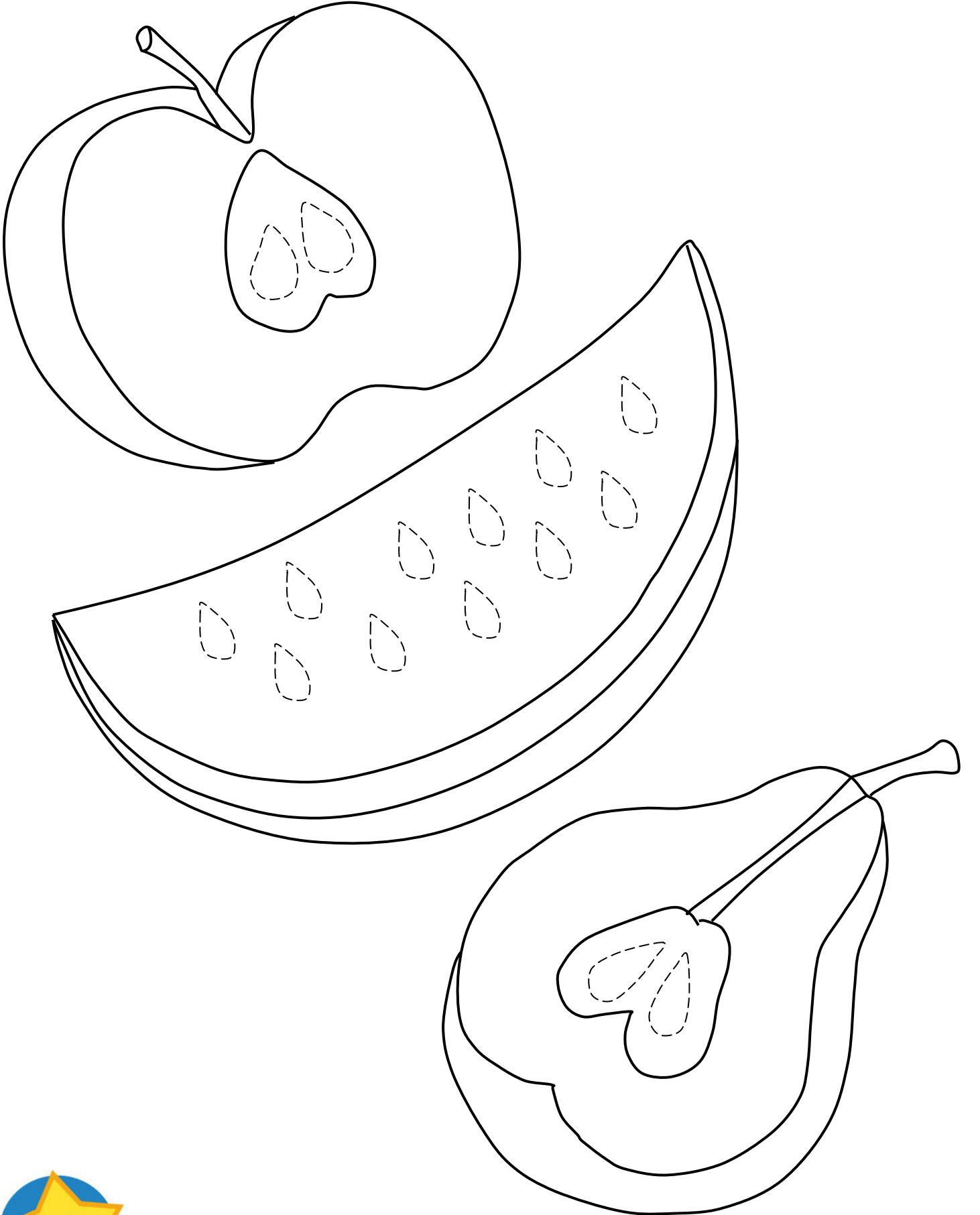



@Arabic\_Books

وَبَدَّةٌ

الْمَاءِ



## استعمال الماء، ألون صور الأشخاص الذين يستخدمون الماء.

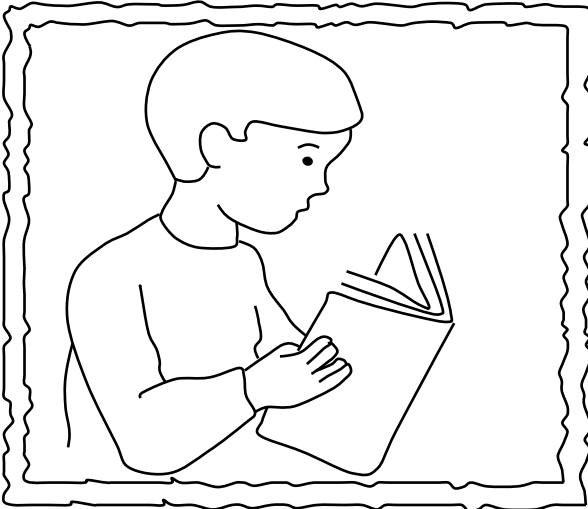
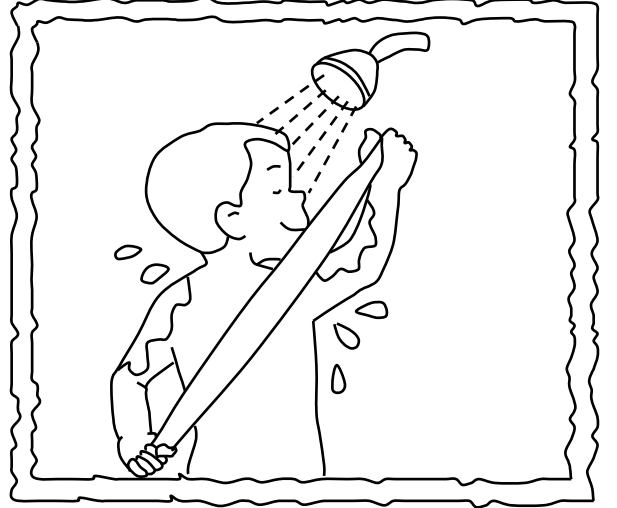
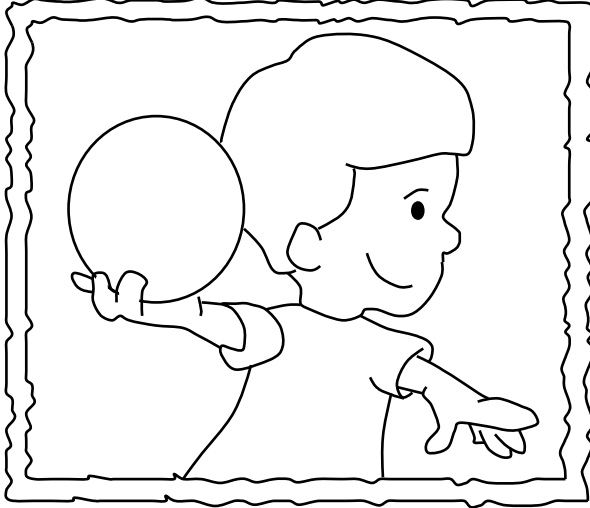
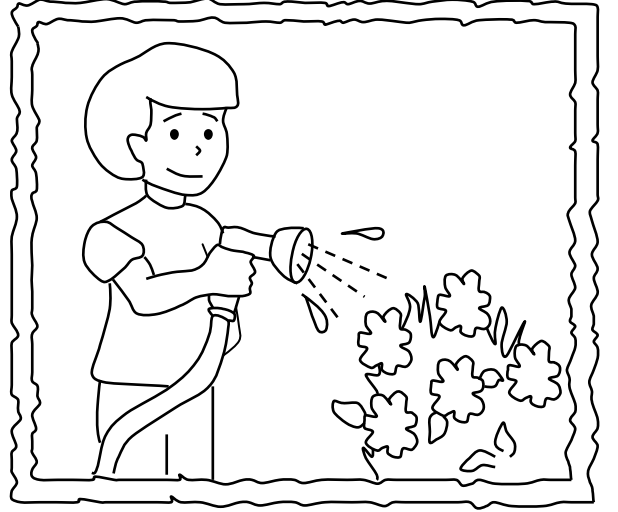
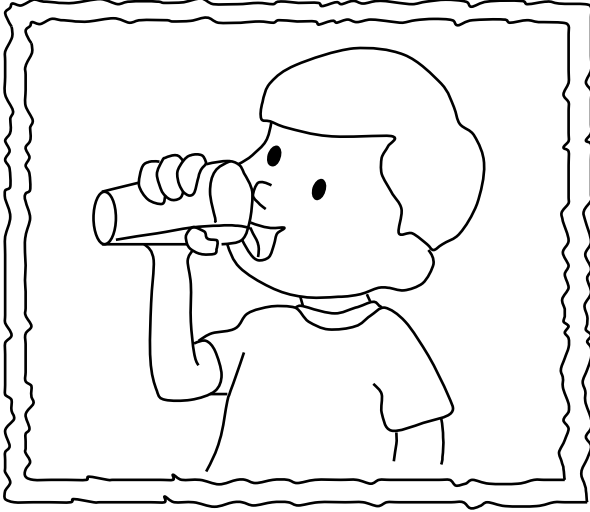

## أتعرف على مصادر المياه.



مطر

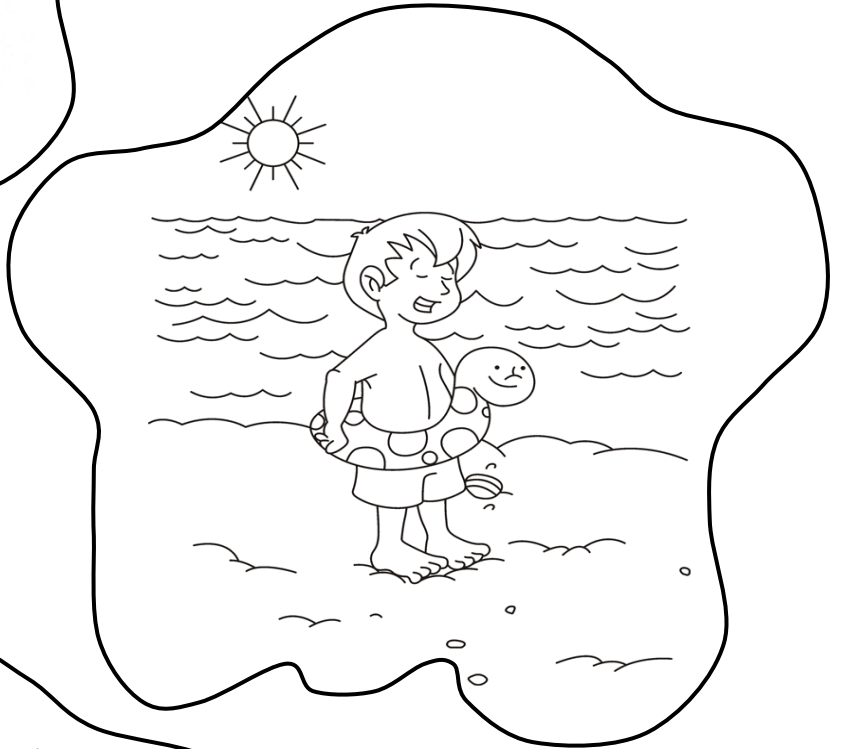

بحر

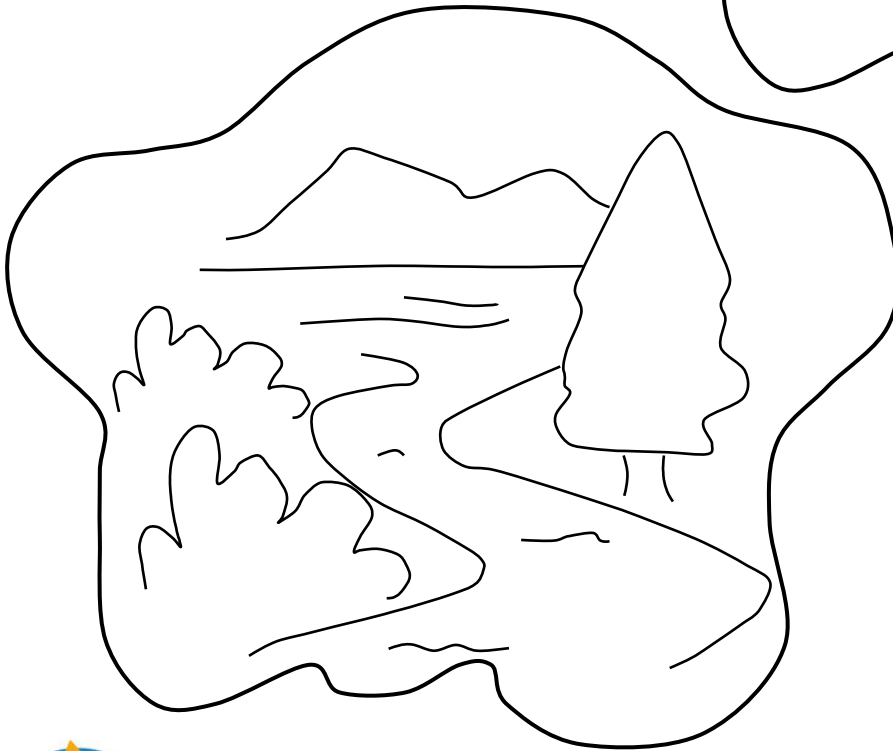

نهر



# أحوط الكائنات الحية التي تحتاج إلى ماء كي تعيش.

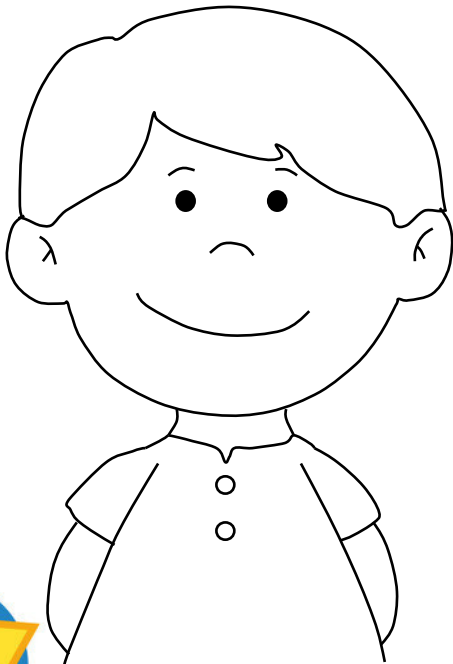
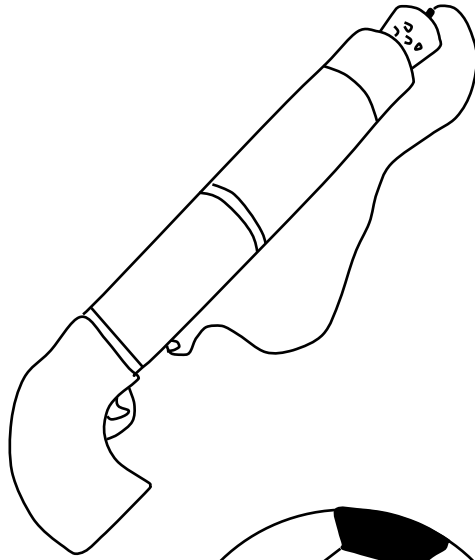
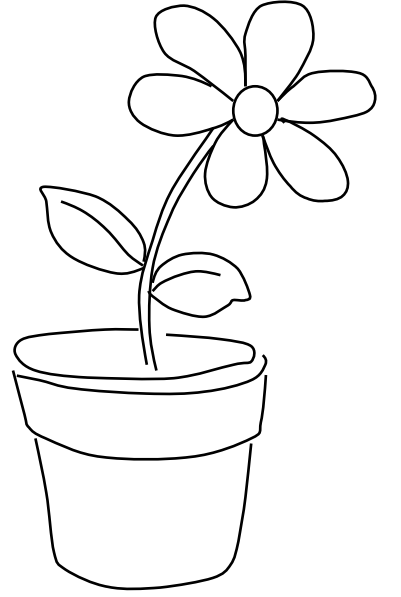
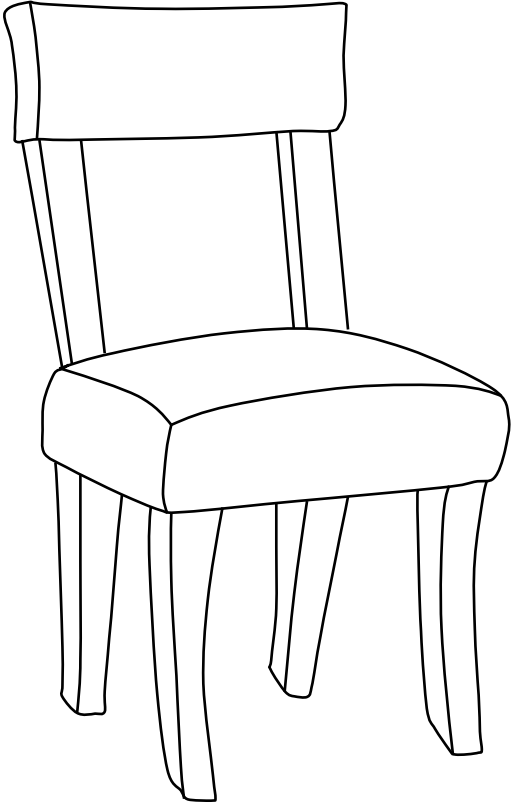

## الكائنات البحرية.

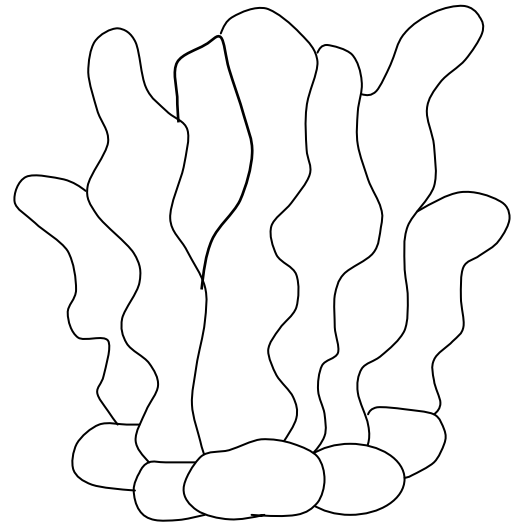
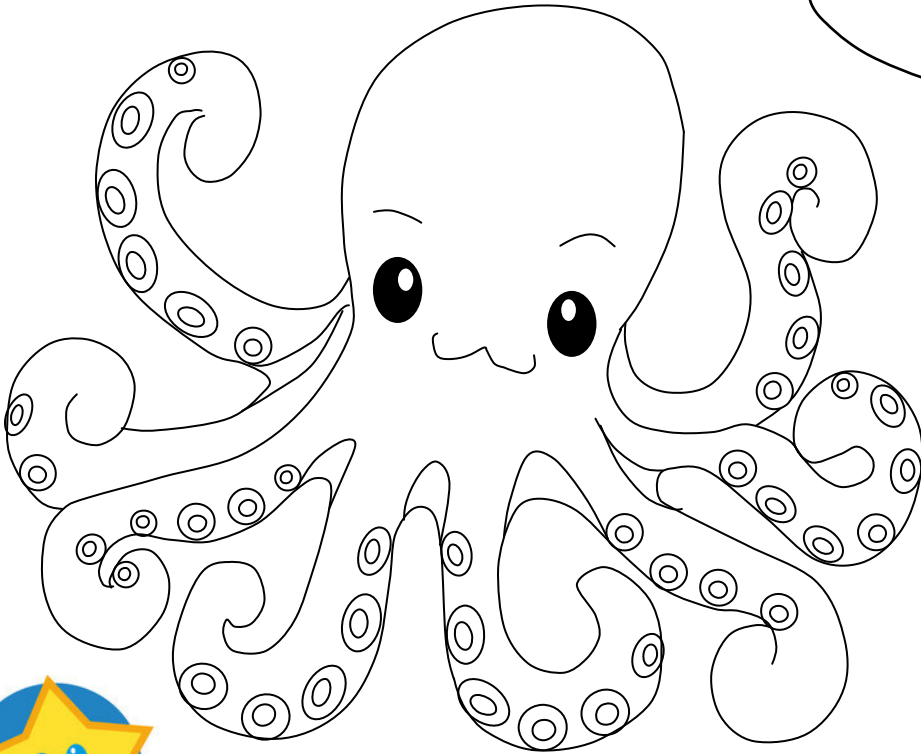
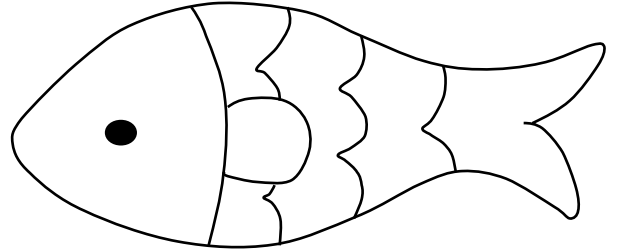
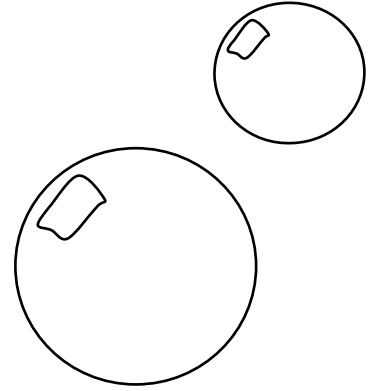
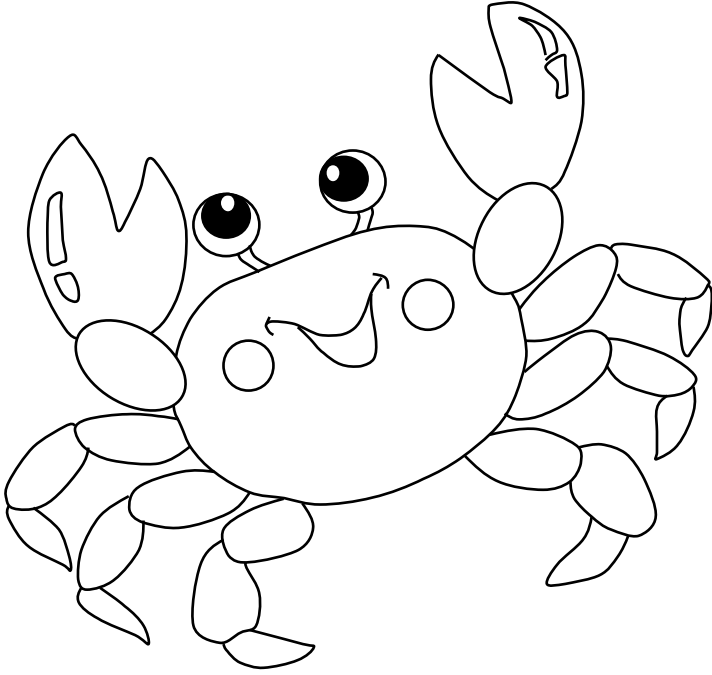
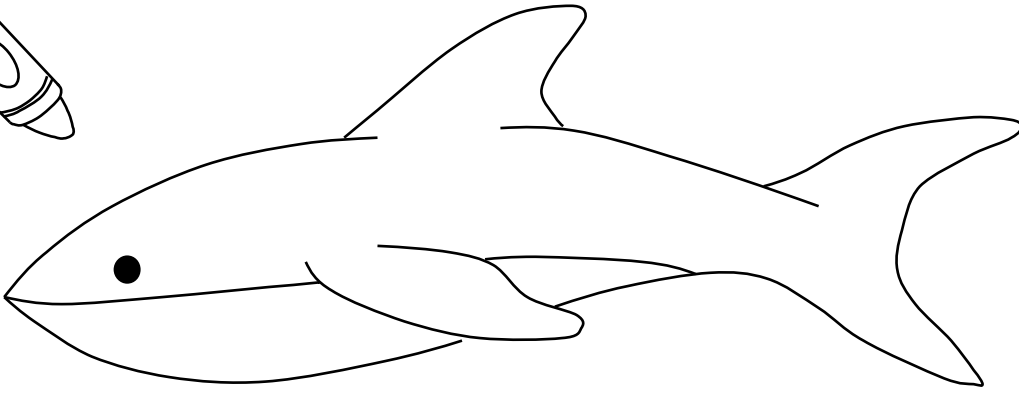
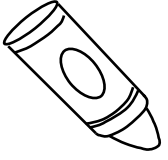



 @Arabic\_Books

وحدة

المواصلات





## أصل وسيلة المواصلات بالمكان المناسب.

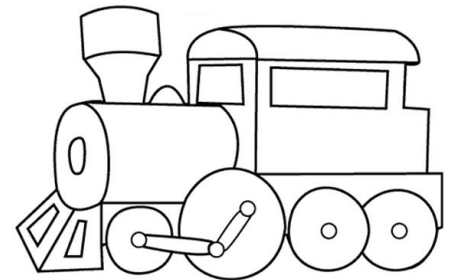
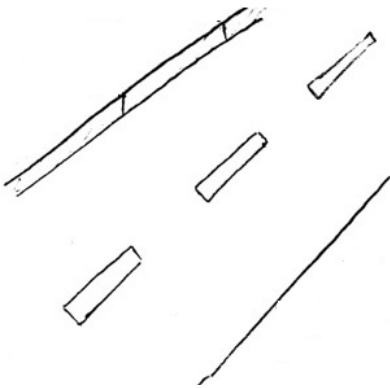
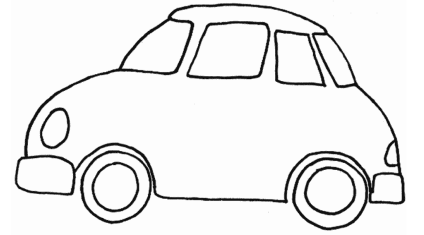
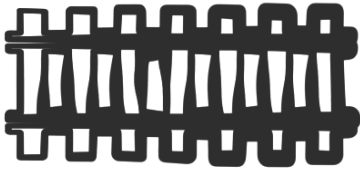
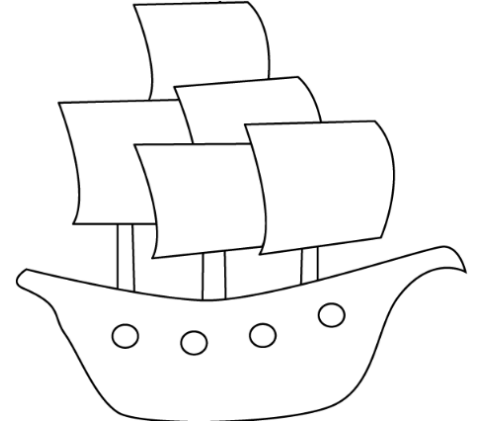
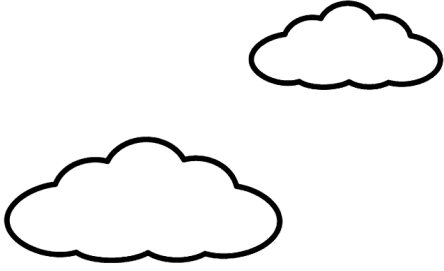

## للسيارات ألوان وأحجام ، أطبق وأصل.

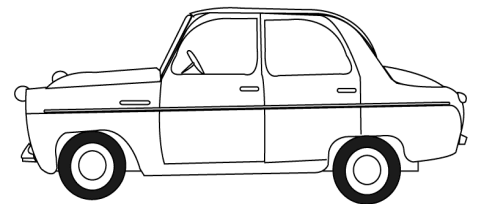
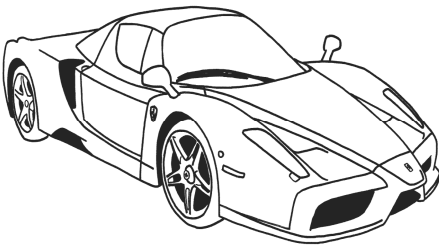
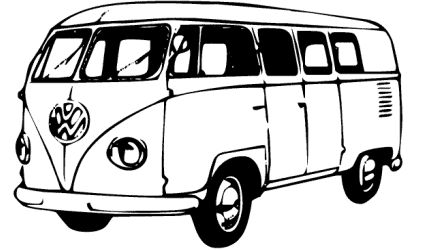
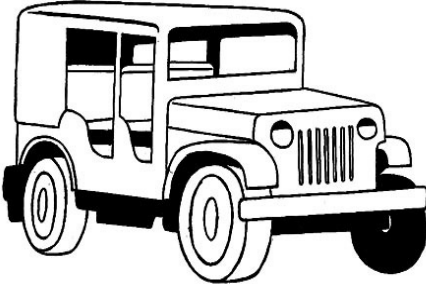
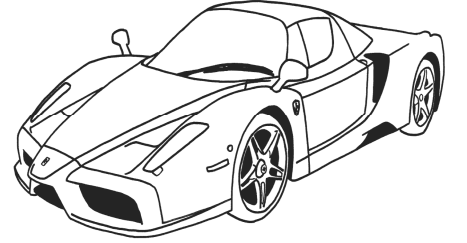
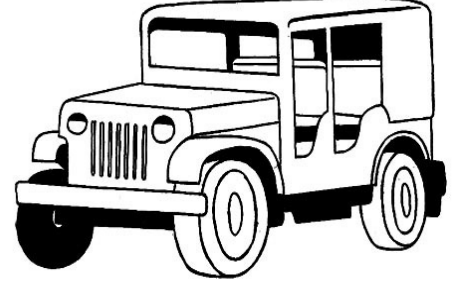
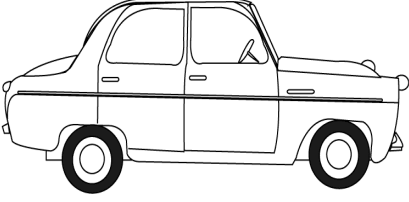

أبحث عن أربعة أجزاء للسيارة وأحوظها.

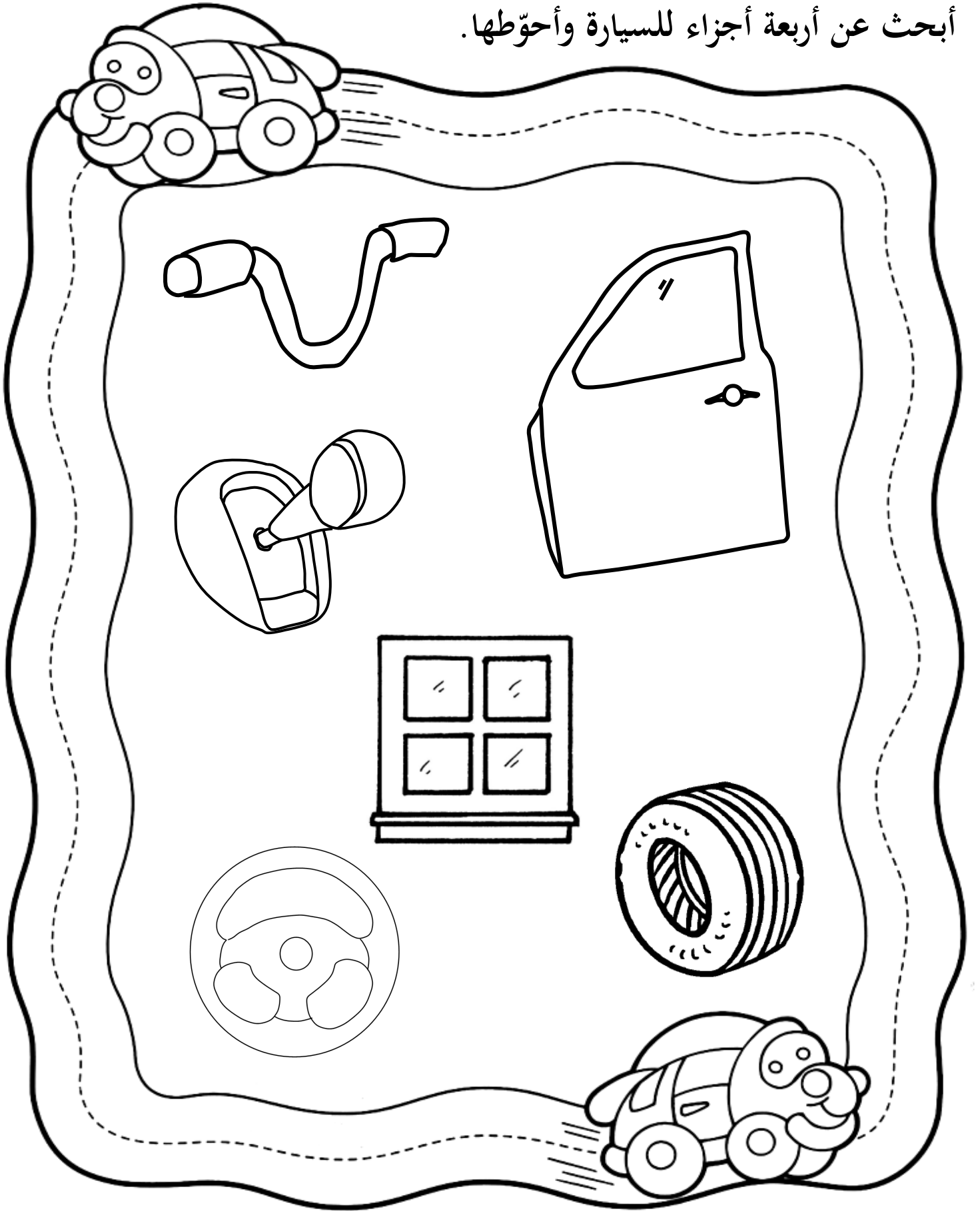

ألّون الوسيلة التي تساعدني في الذهاب إلى روضتي.



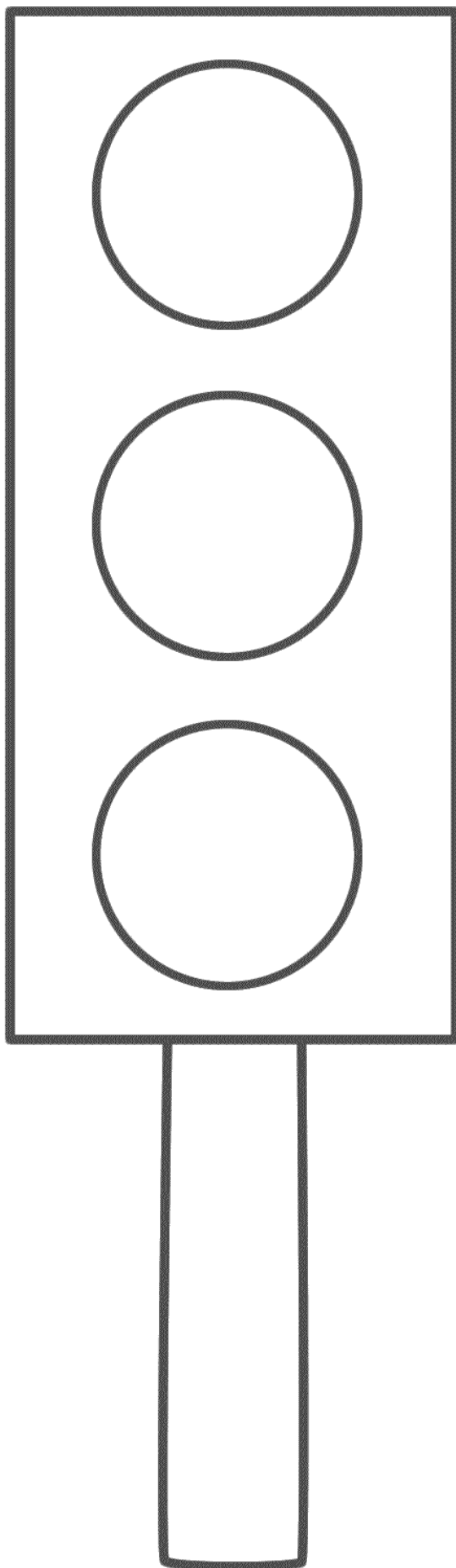
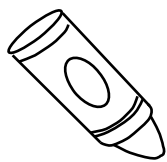

ألوان  
إشارة  
العبور





@Arabic\_Books

وحدة

السيرة النبوية



أخطط على اسم نبينا محمد ﷺ

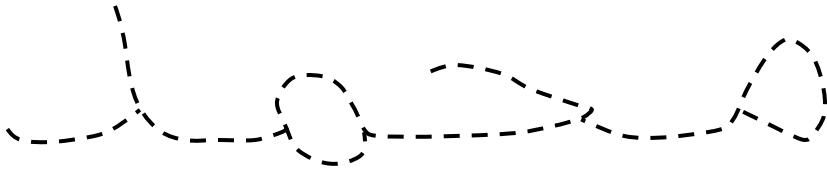
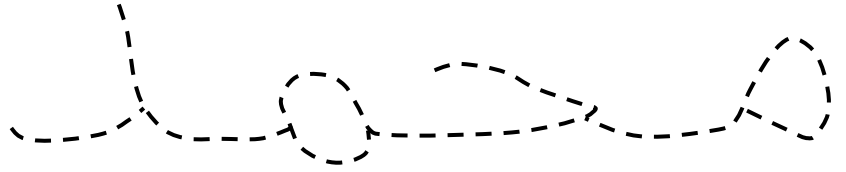
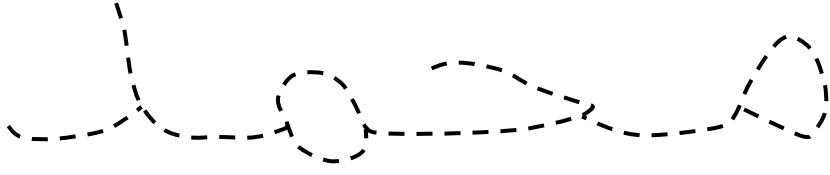

صلى الله عليه وسلم

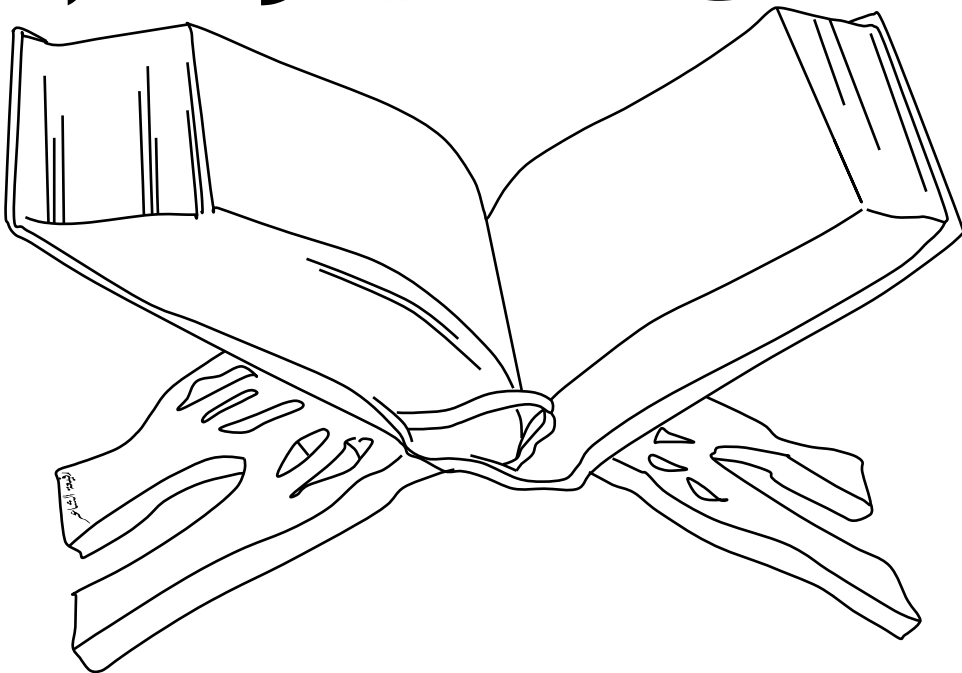

أطابق وأصل.

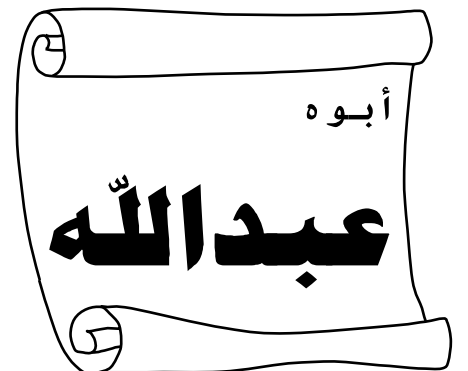
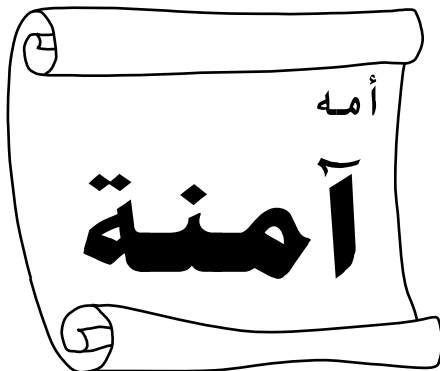
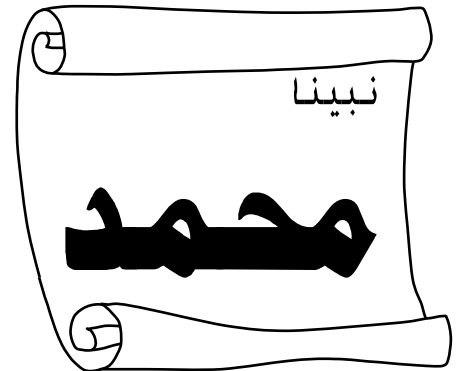
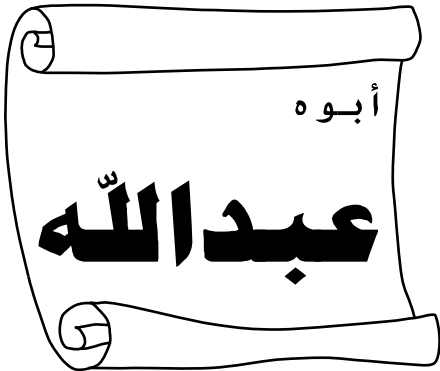
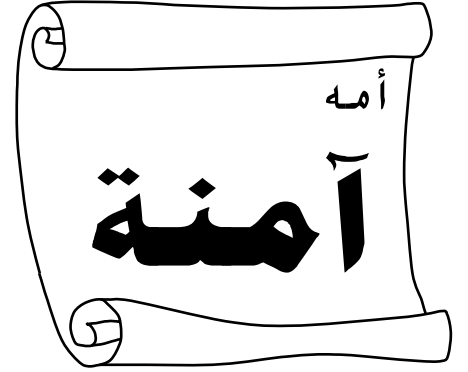
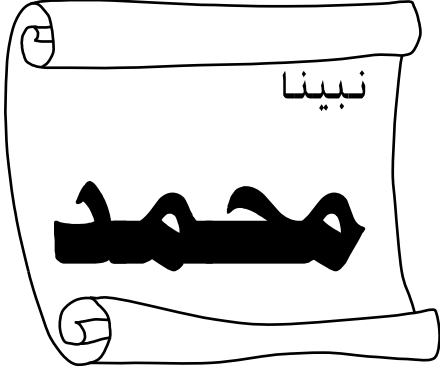



ماذا اشتغل الرسول ﷺ وهو صغيراً؟ ألون إجابتي.

## النجارة

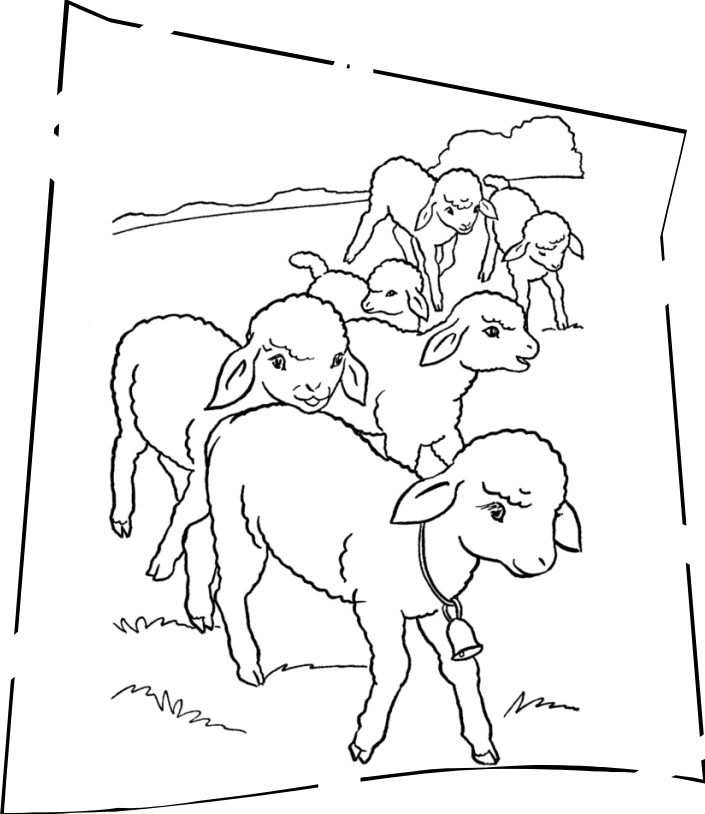

## رعي الغنم

## المصيد

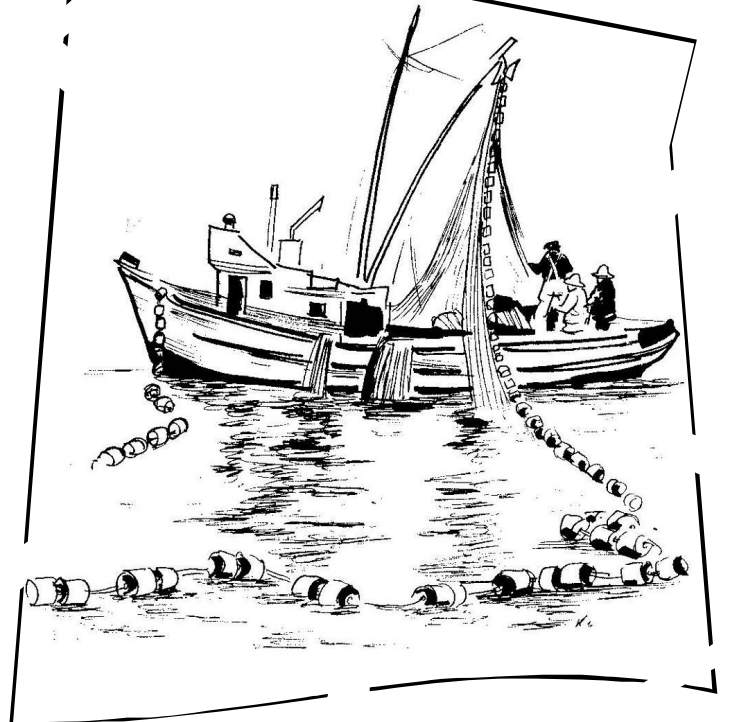



أَلَوْنُ صِفَاتِ حَبِيبِنَا رَسُولِ اللَّهِ ﷺ وَسَيِّدِنَا

الصدق

الأمانة

الكرم



العطف على الفقر، ألون الصورة التي تدل عطف مروان على الفقراء.

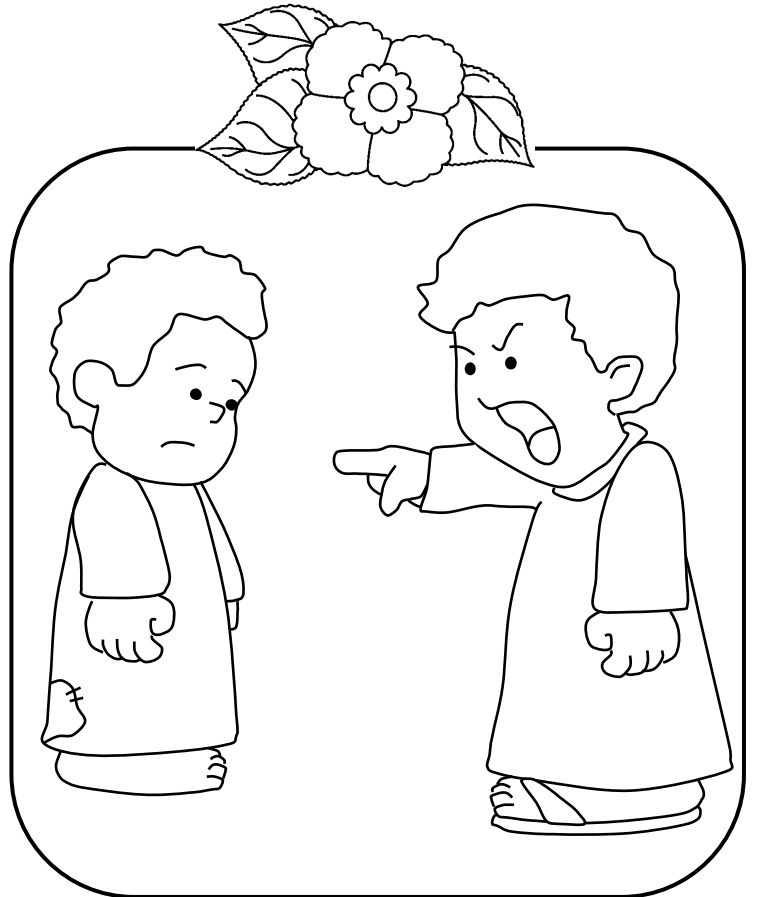
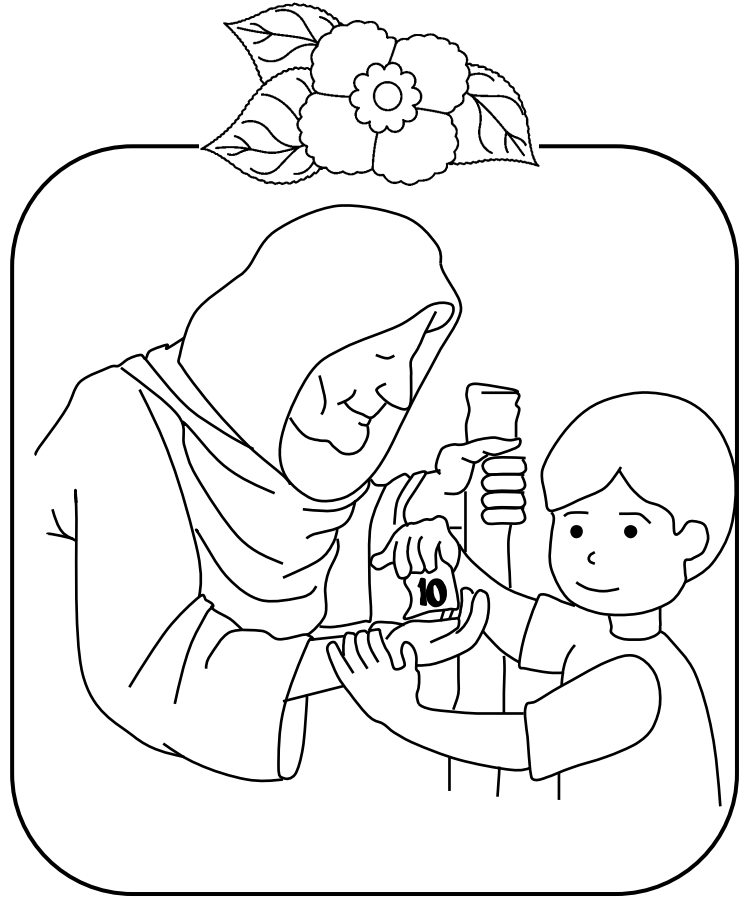
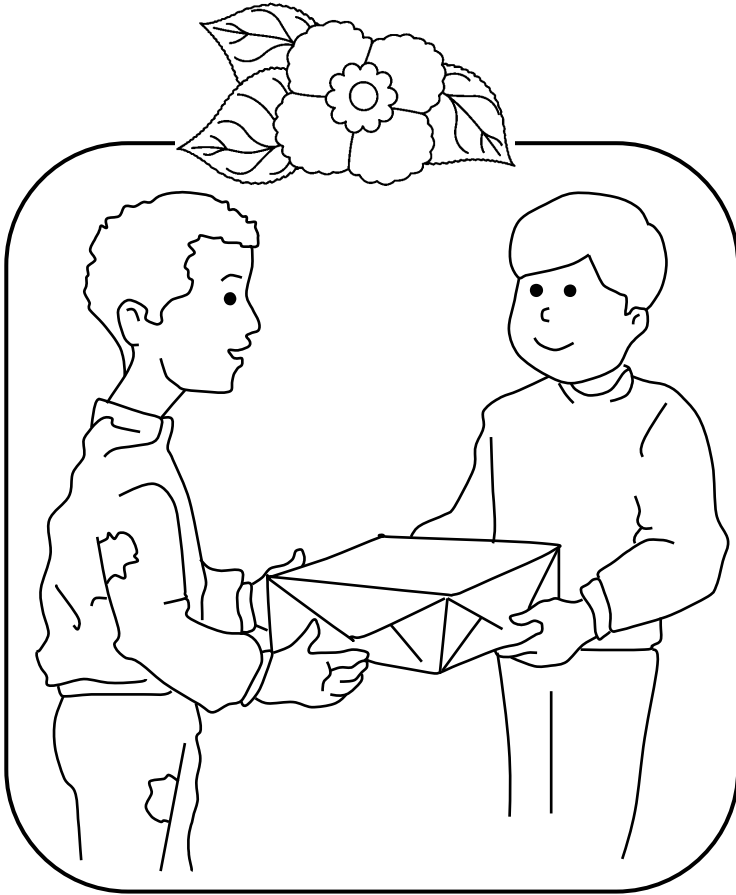



@Arabic\_Books

وحدة

السياحة



## معالم بلادي كثيرة. أطابق وأصل.

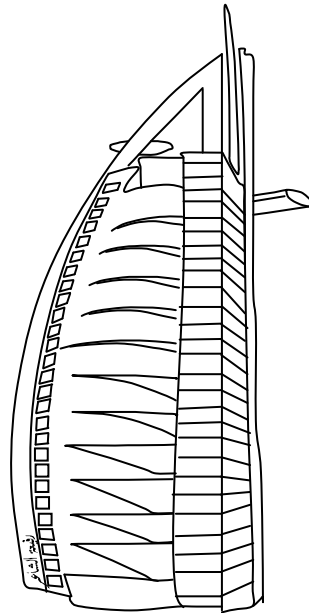
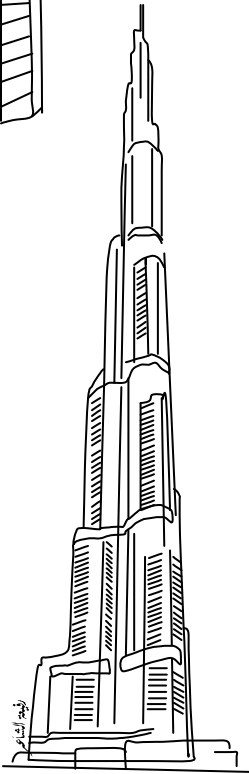
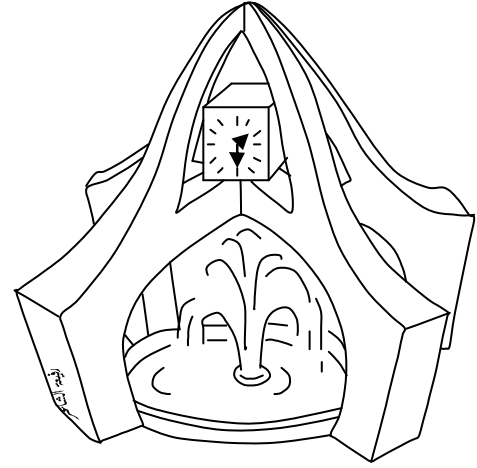
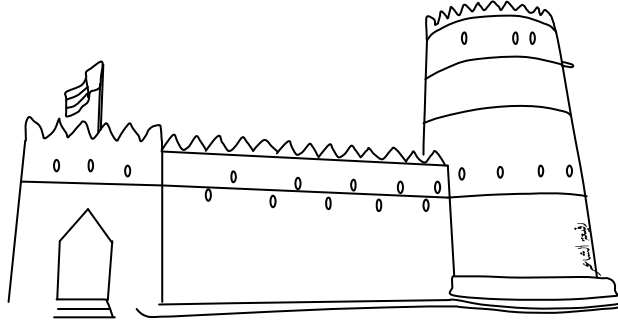
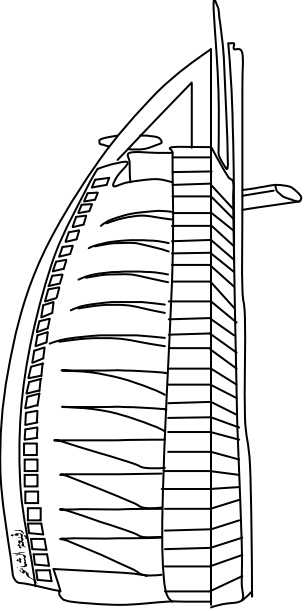
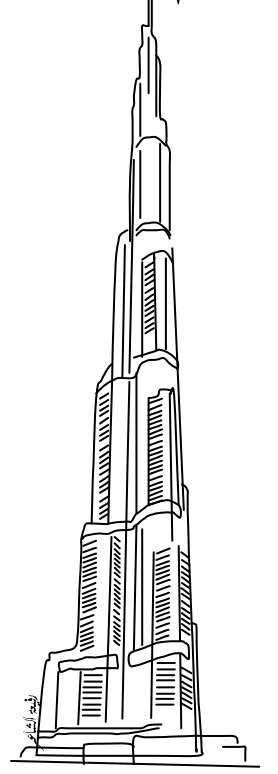
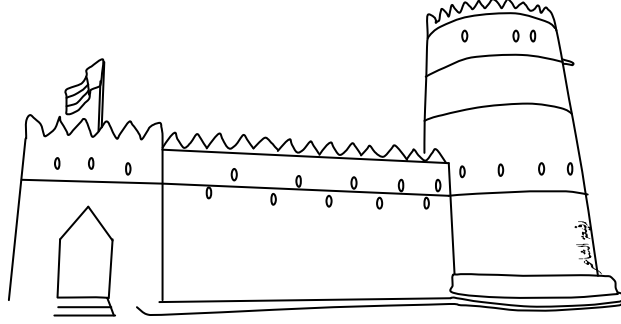
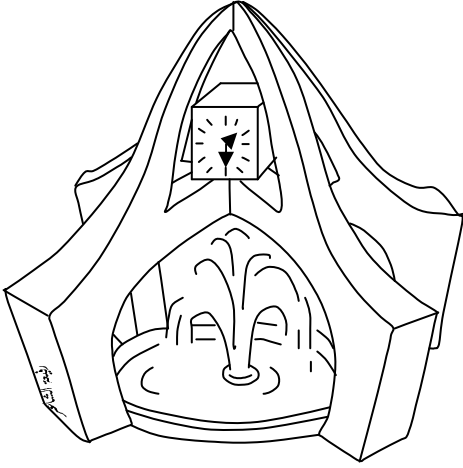

أصل السيارة إلى المطار.

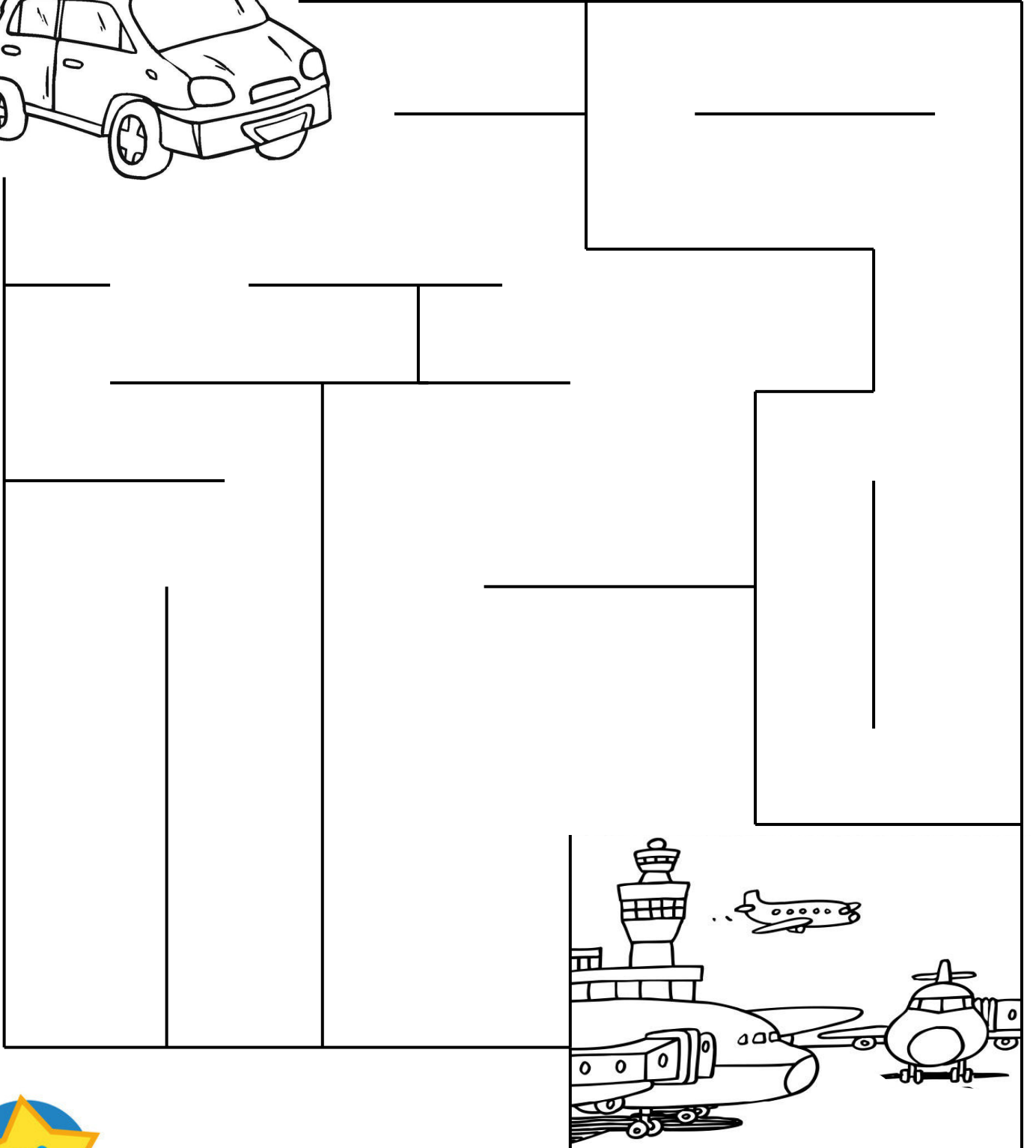
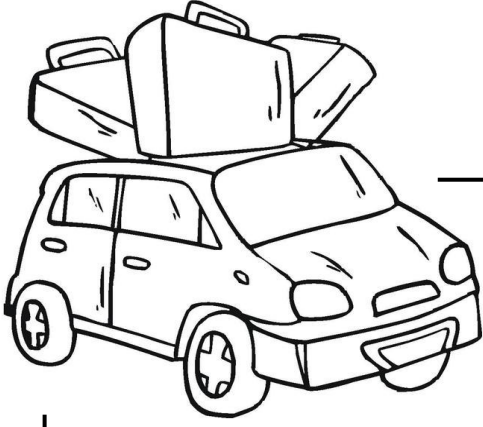

ماذا أحمل معي في حقيبة سفري؟ أحوط إجابتي

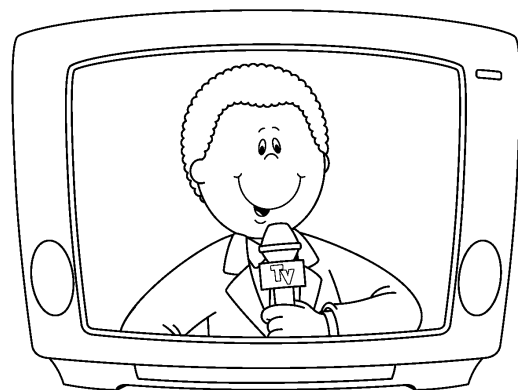
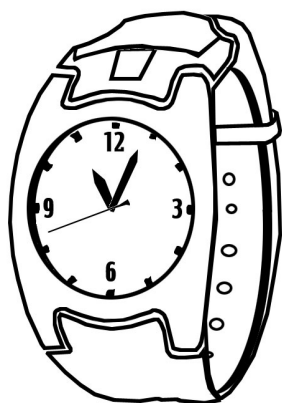
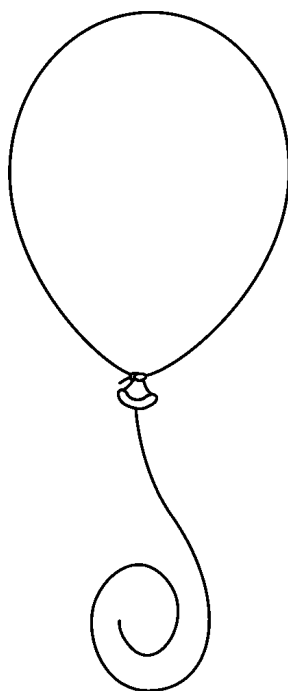
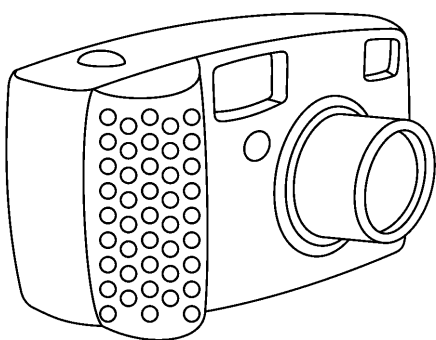
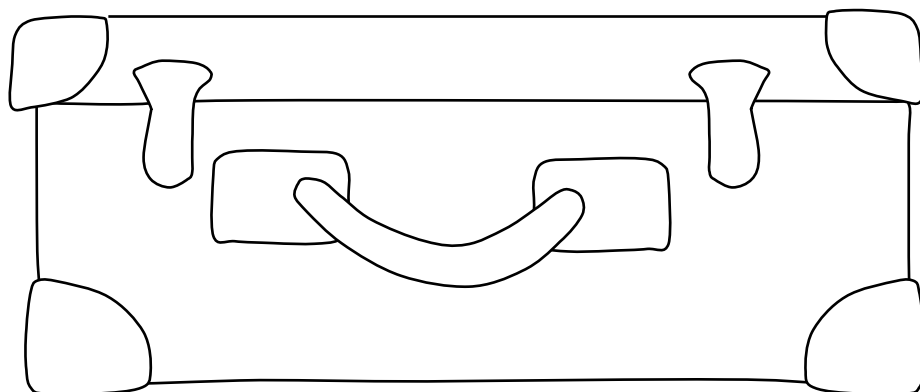

أتعرف على بعض معالم الدول الخليجية ، ألون.

باب البحرين

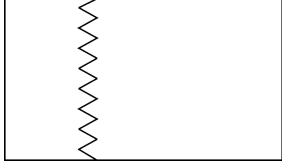

البحرين



سوق واقف

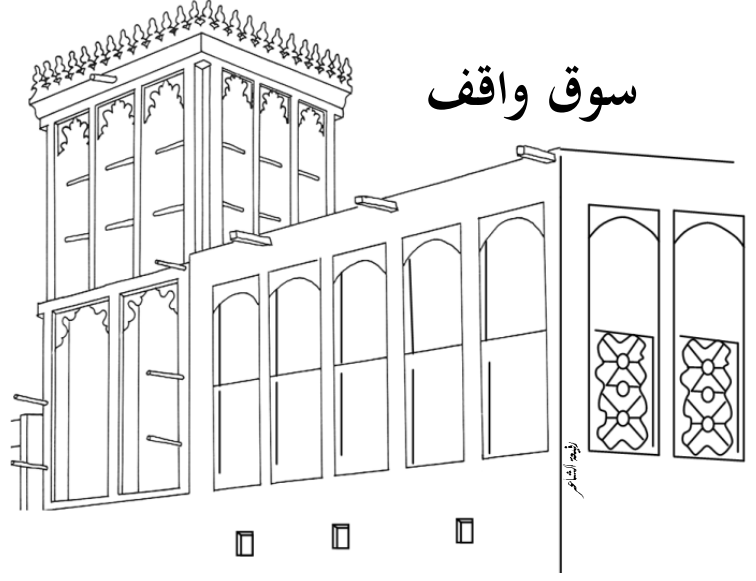

قطر

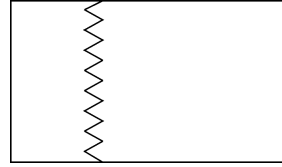

أبراج الكويت

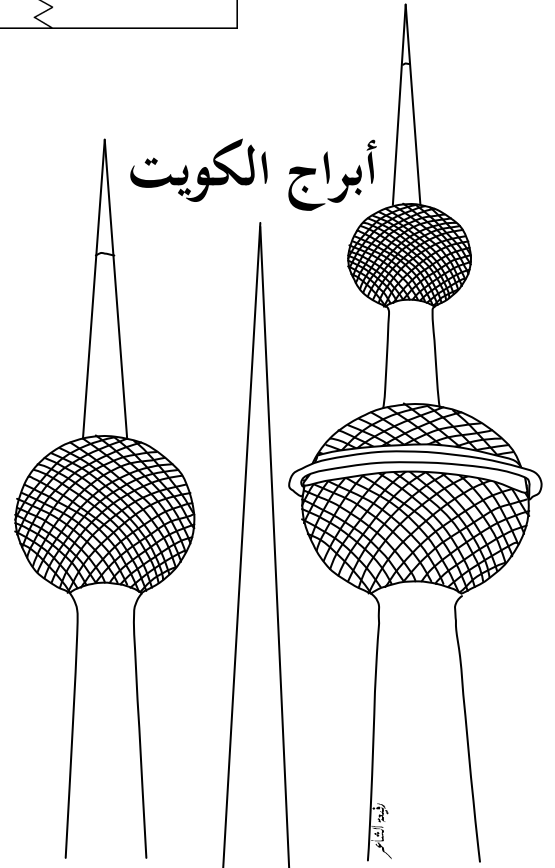

الكويت

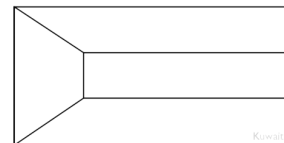

قلعة بهلاء

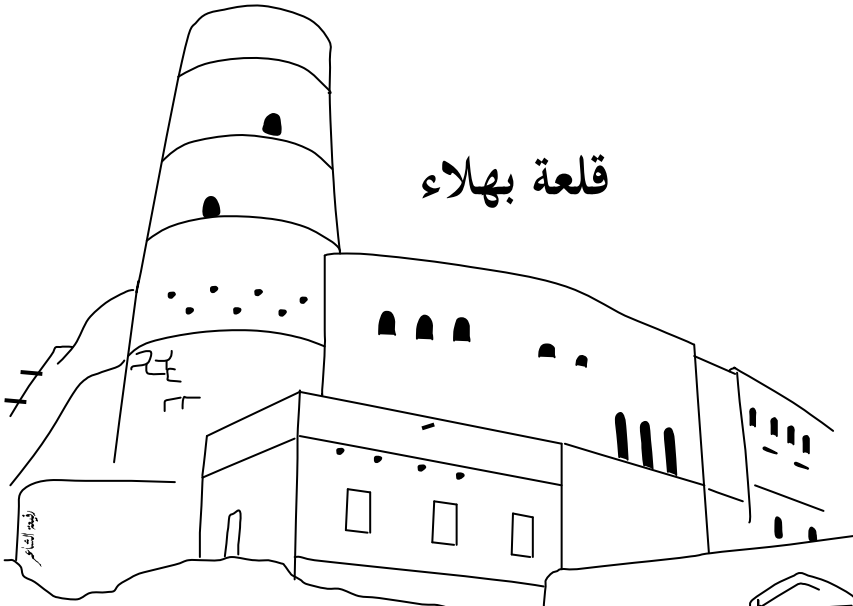

عمان

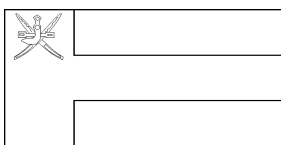





@Arabic\_Books

وحدة

الكتاب





# القرآن الكريم كتاب الله

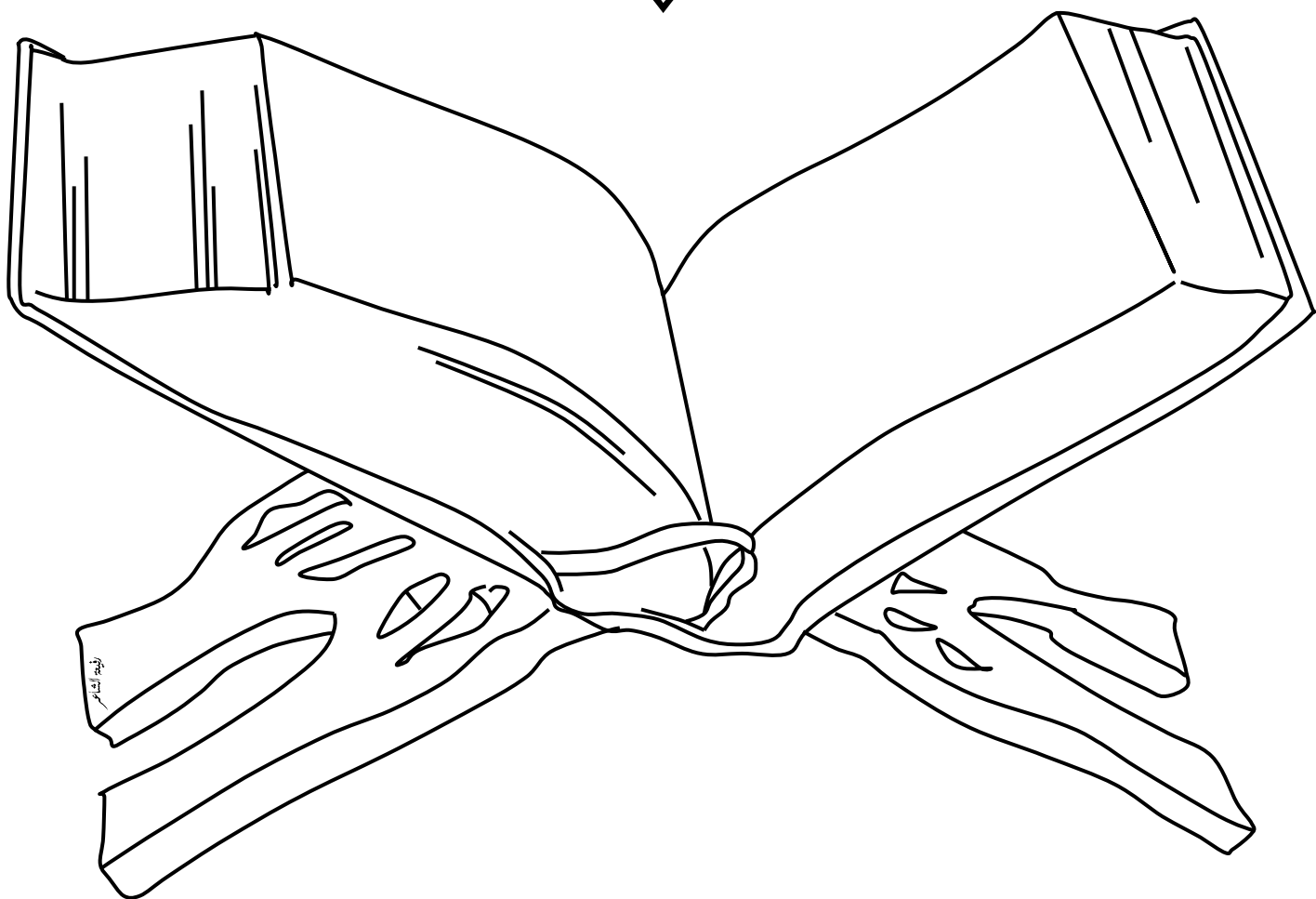

أين أضع كتابي ؟ أصل.



الثلاجة

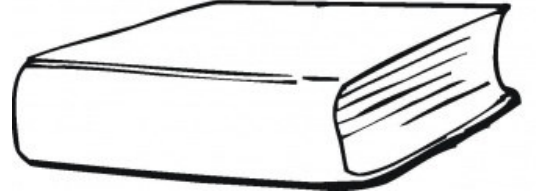

كتابي

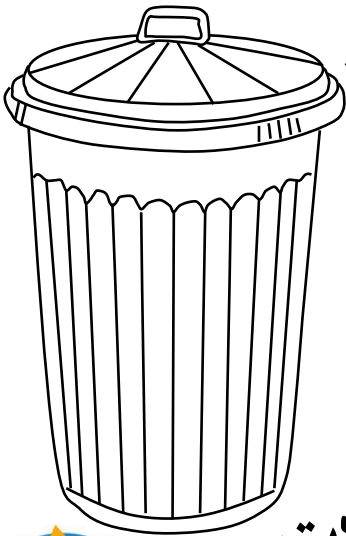

سلة المهملات

المكتبة

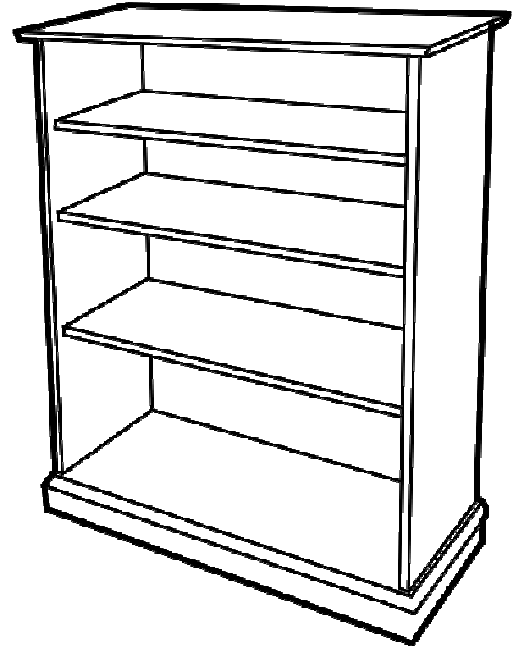

أحبُّ كتابي وأحافظ عليه، ألَوّن الصورة التي تدل على ذلك.

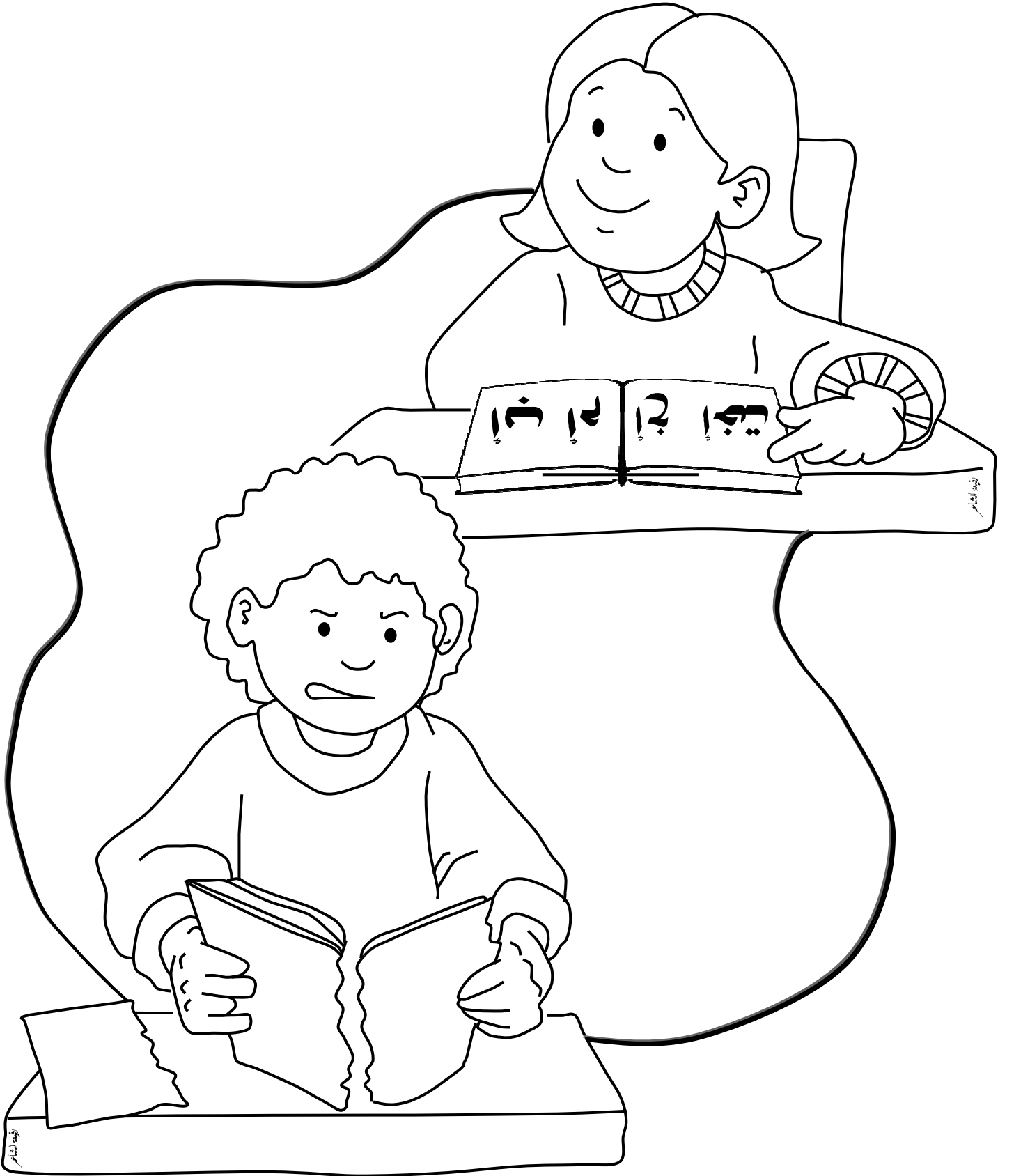

## للكتب موضوعات مختلفة، أطبق وأصل.

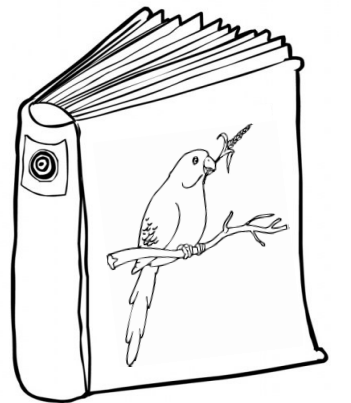
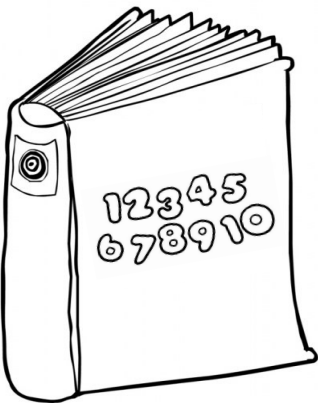
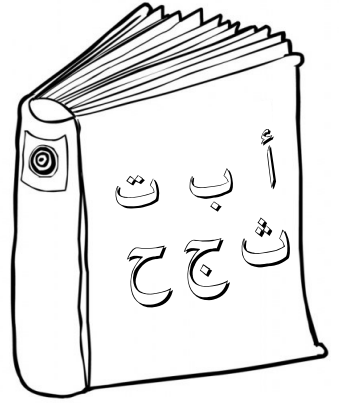
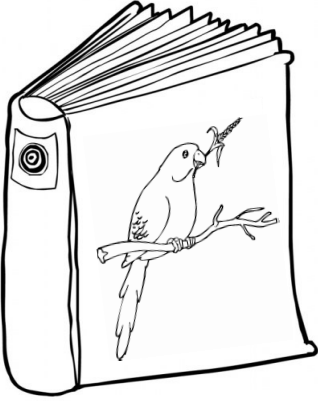
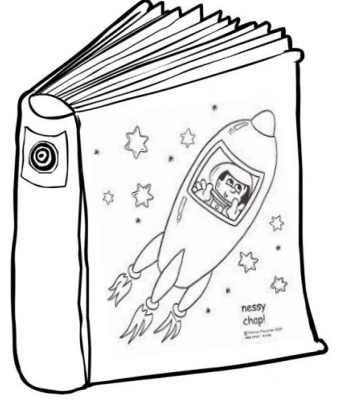
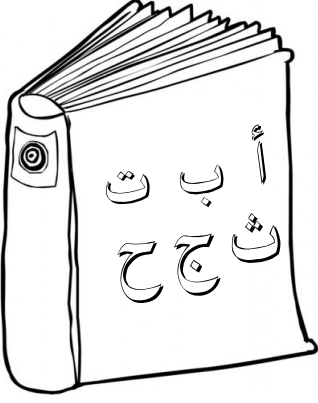

أبحث عن شكل المثلث ألونه.

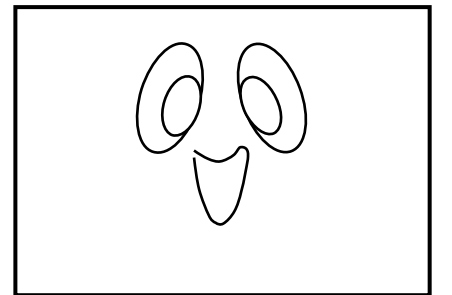
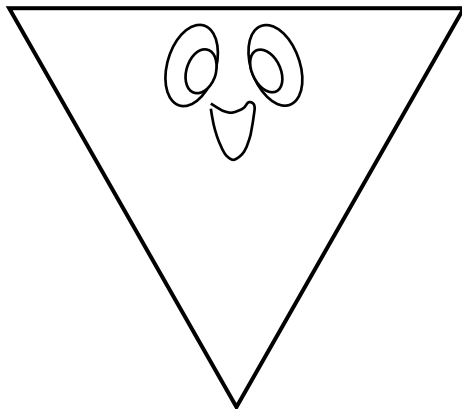
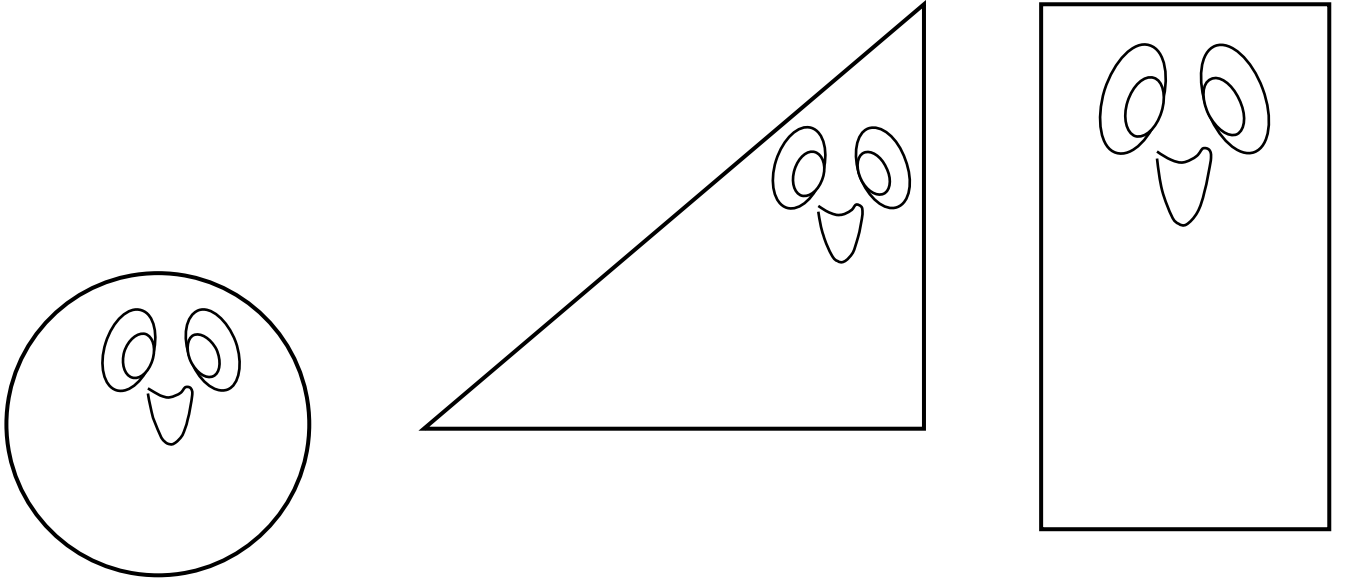
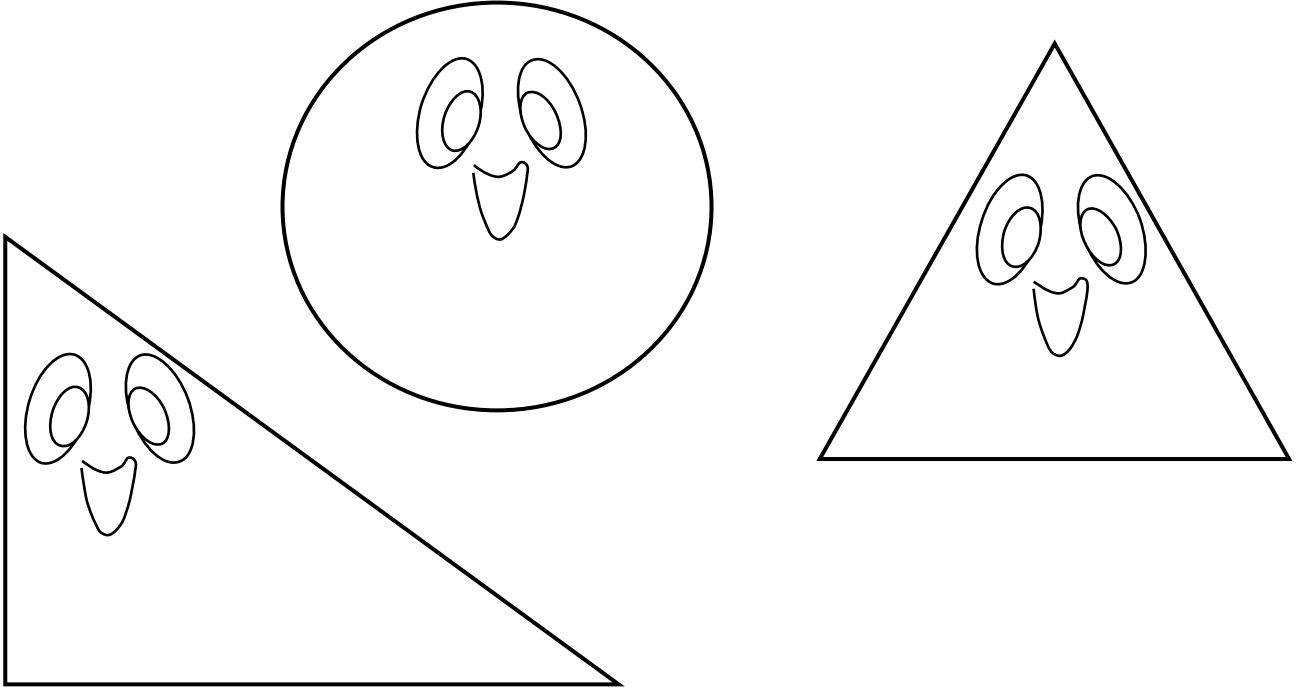



@Arabic\_Books

وحدة

البيئة





البيئة كل ما يحيط بنا، أحوط مفهوم البيئة.

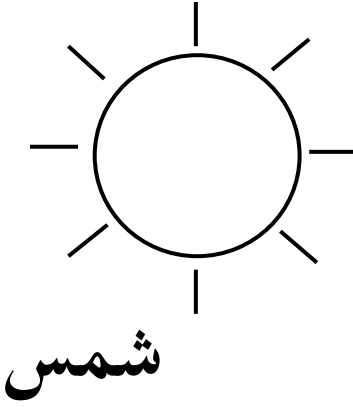

شمس



هواء

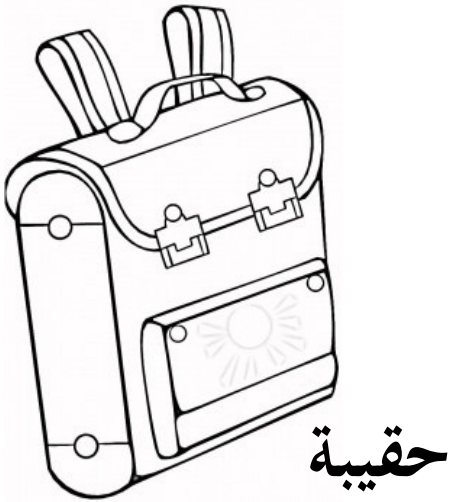

حقبة

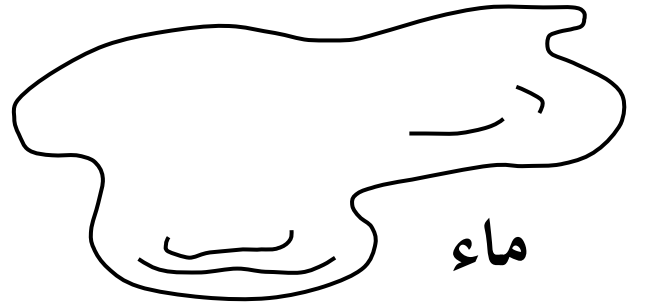

ماء

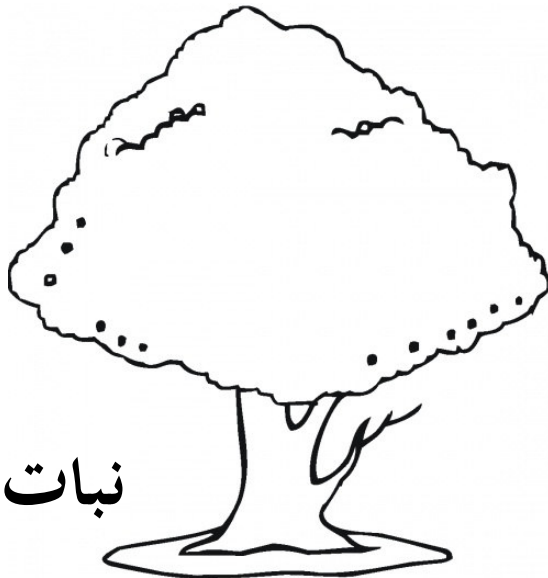

نبات

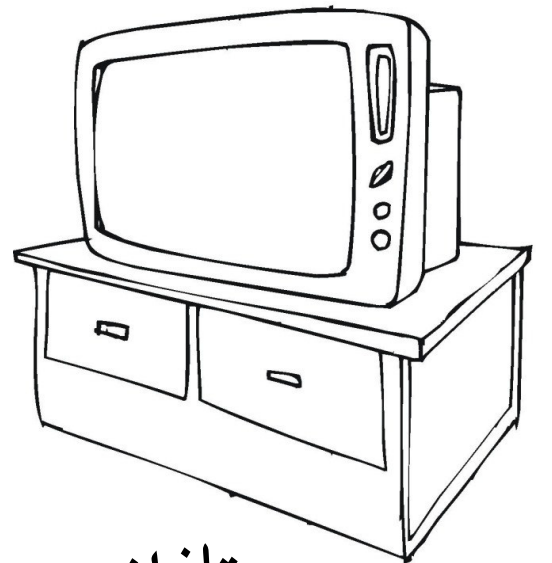

تلفاز





تلوث الهواء، ألّون ما يلوث الهواء باللون الأسود.

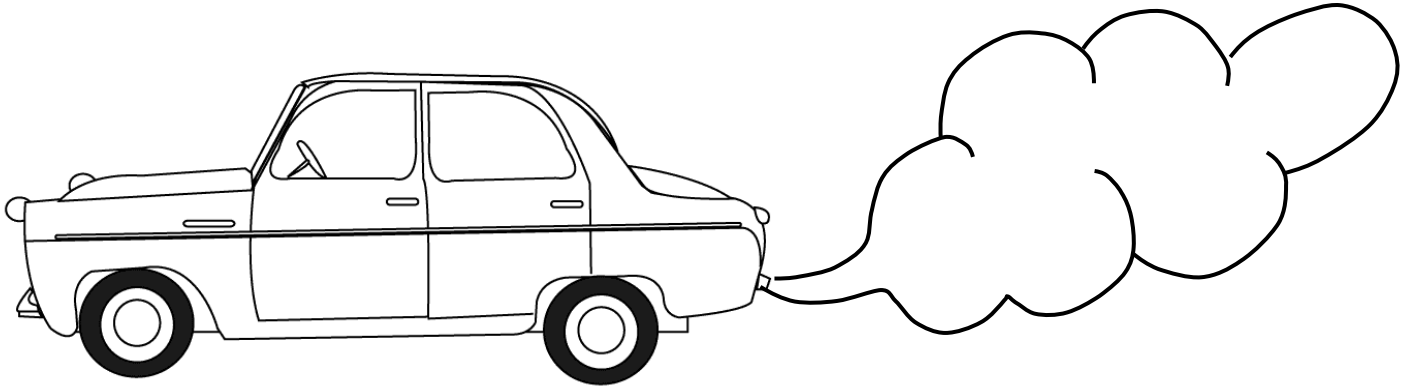
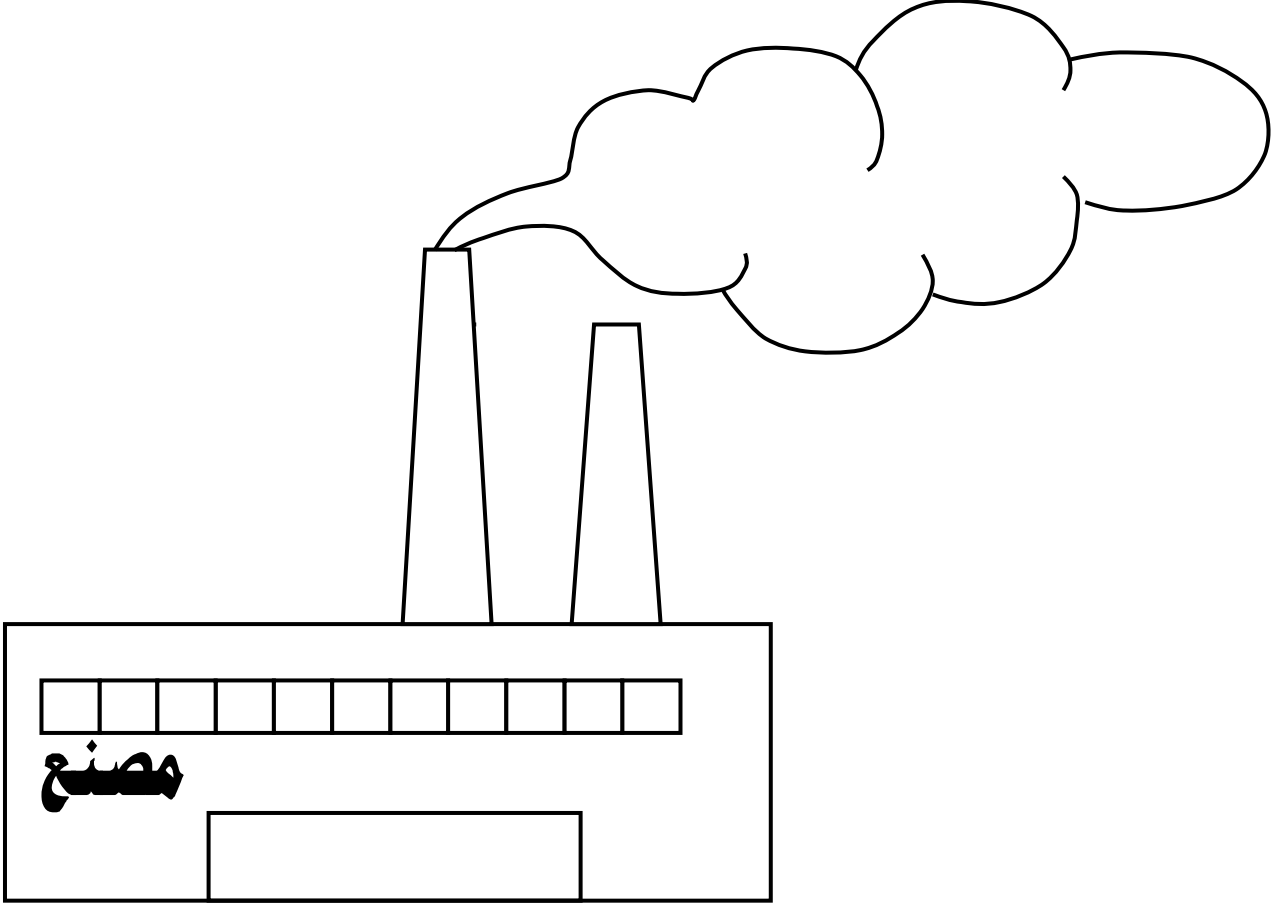

أرسم علامة **X** على السلوك الخاطئ في المحافظة على البيئة.

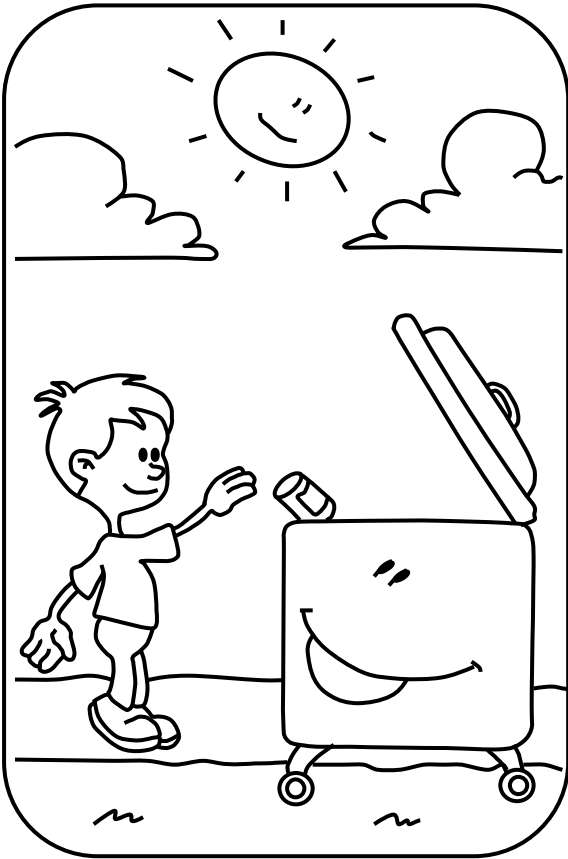
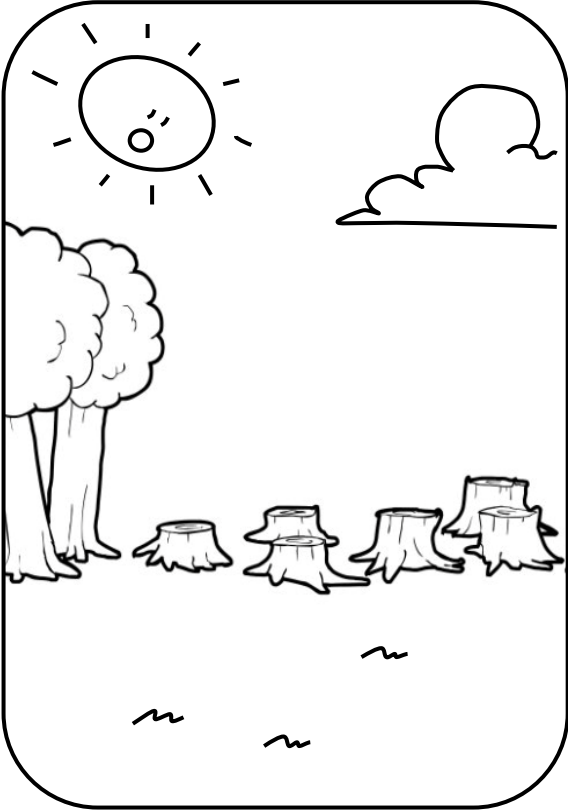

كيف يمكن للطفل أن يحافظ على بيئته؟



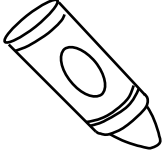

# بيئتي نظيفة





@Arabic\_Books

وَبَدَّةٌ

الْفَضَاءِ





ماذا يوجد في الفضاء؟ أحوط.

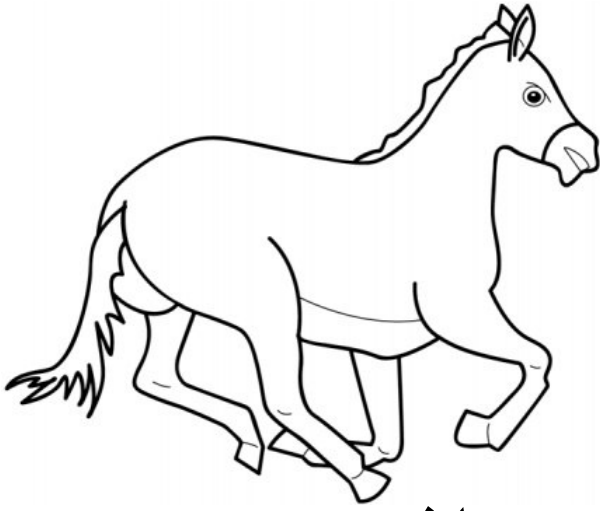

حصان

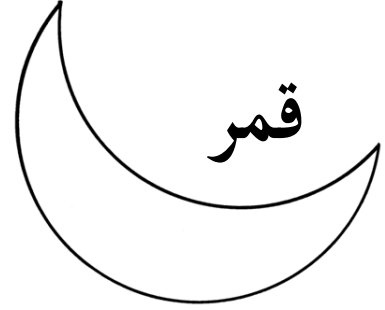

قمر

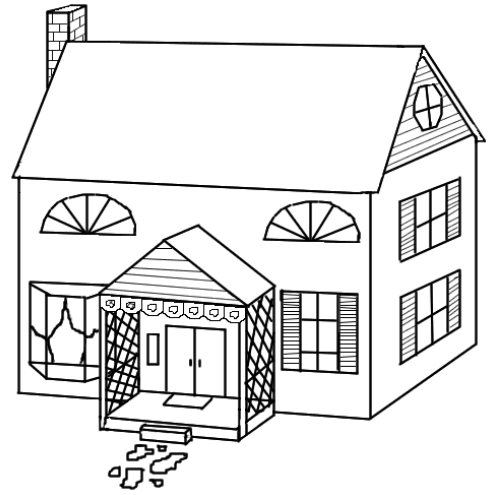

بيت

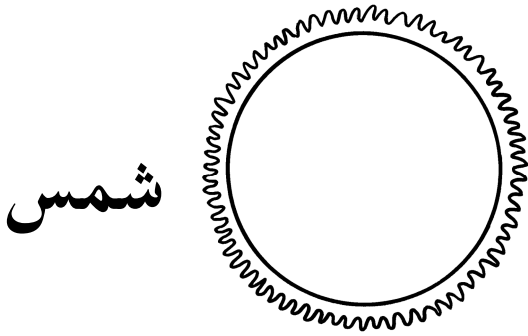

شمس



نجوم

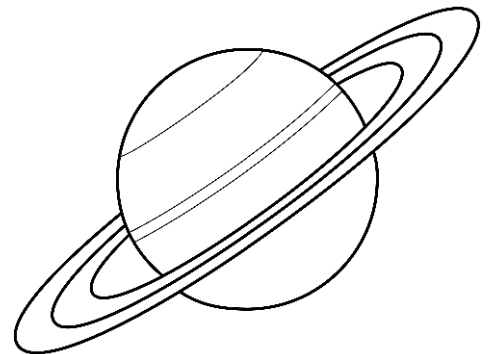

كوكب





الليل والنهار ، أصل .

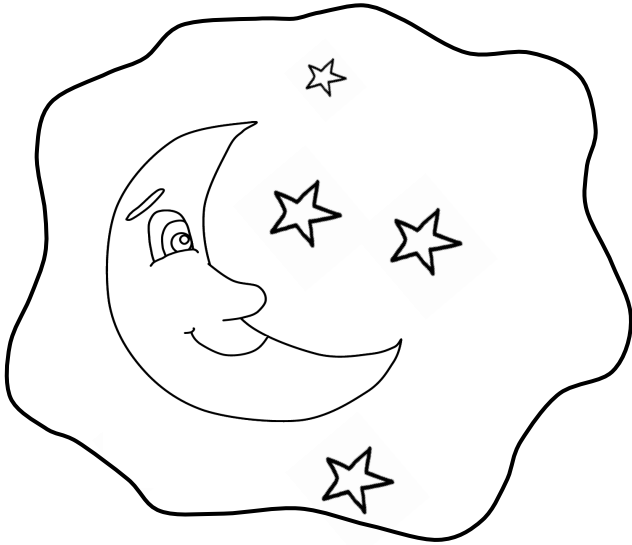
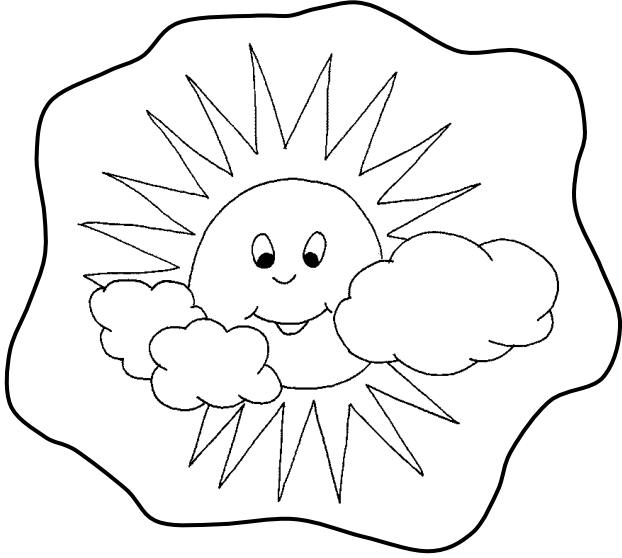

- الشمس والقمر .

اختلاف الليل عن النهار ، قال تعالى " وجعلنا الليل سباتا . وجعلنا النهار معاشا "





أصل رائد الفضاء إلى مركبته الفضائية.

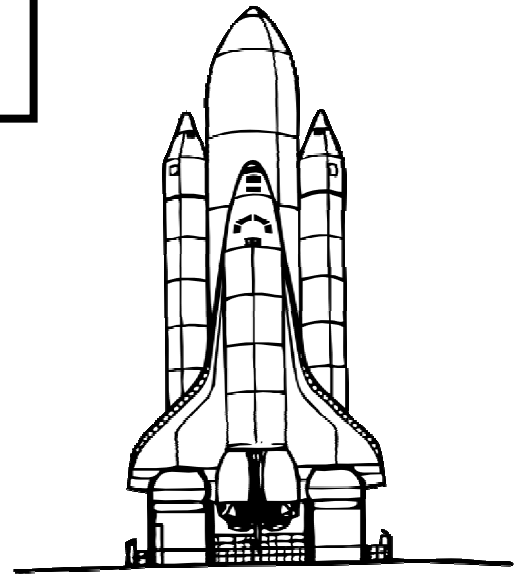
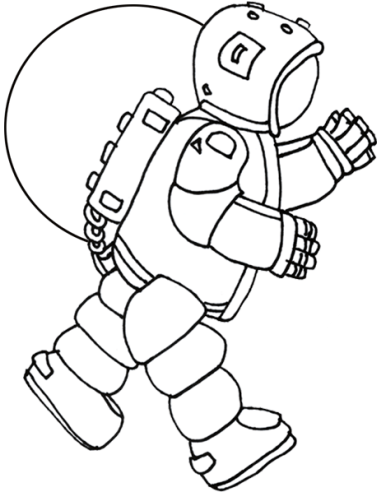



أطابق وأصل.

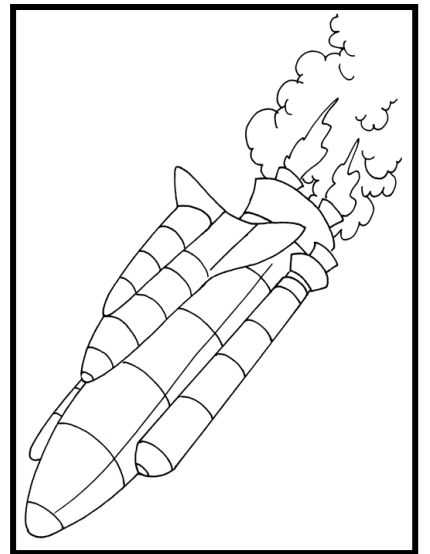
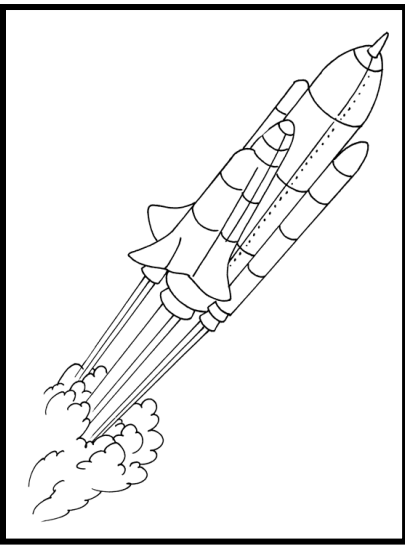
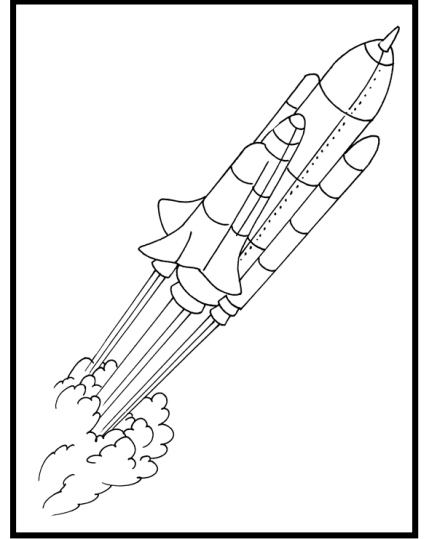
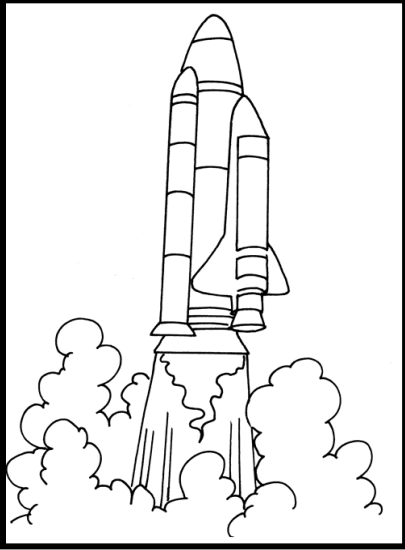
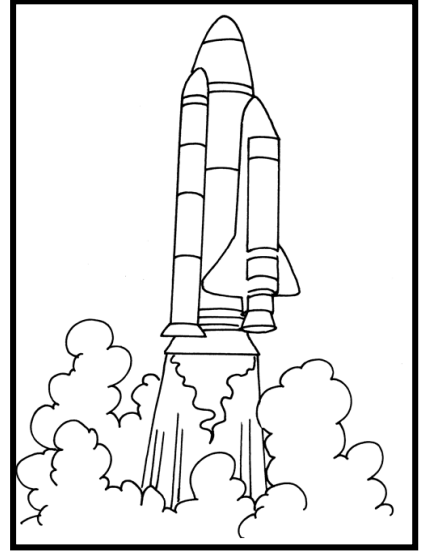
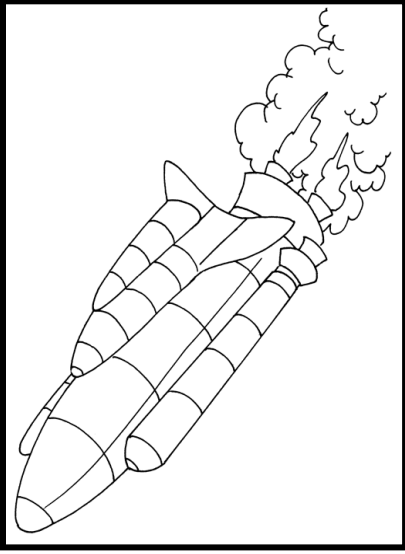



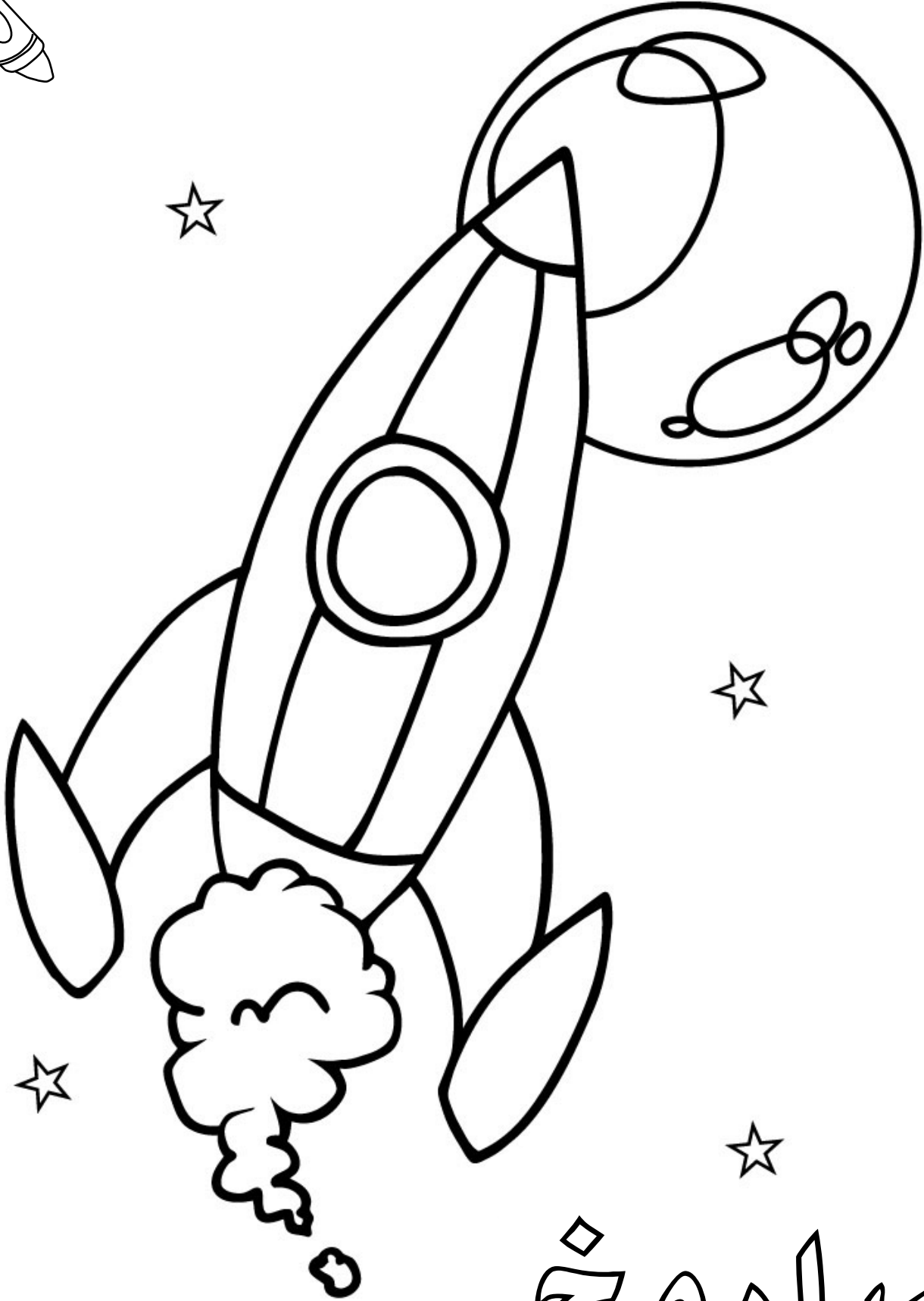
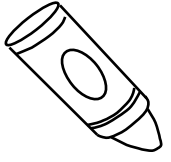

صاروخ





@Arabic\_Books

وحدّة

مع السلامة



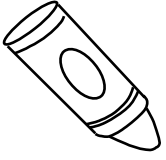

# مع السلامة





## كتاب النشاط قص ولصق



## كتاب وحداتي المستوى الثاني



## كتاب وحداتي المستوى الأول

