



لون واكتب

الخَرَكَات

الكسرة



@Arabic_Books

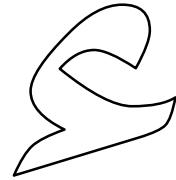
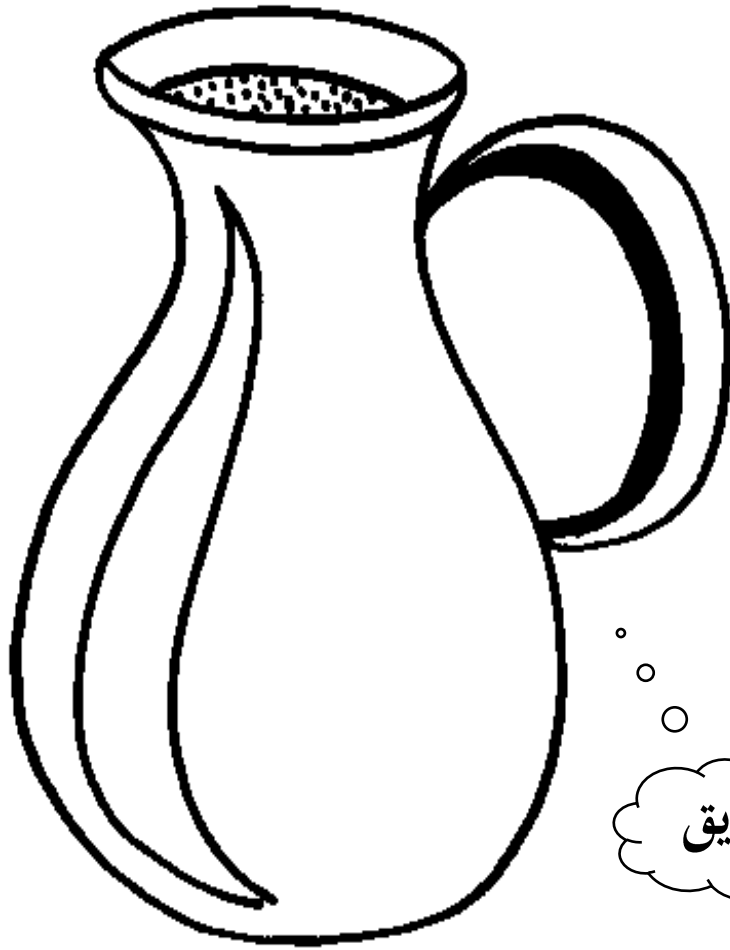

أَيْن

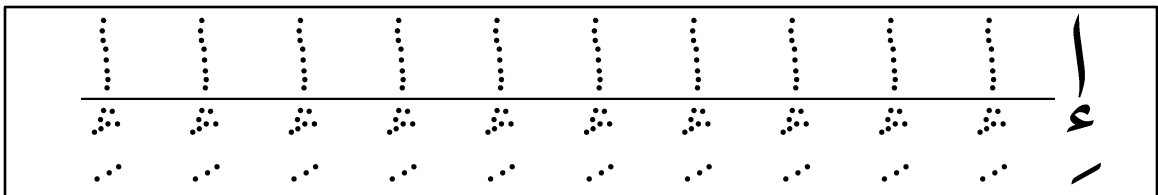
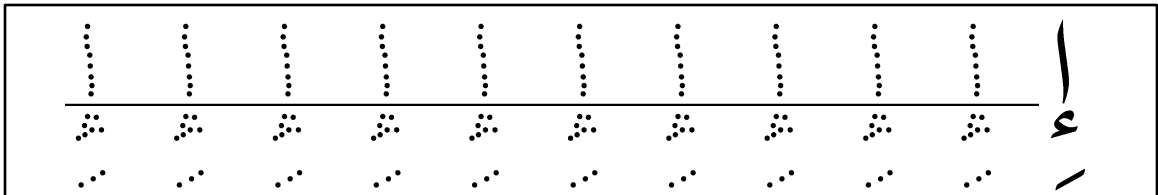
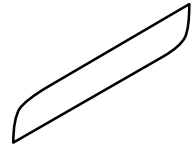

تمساح

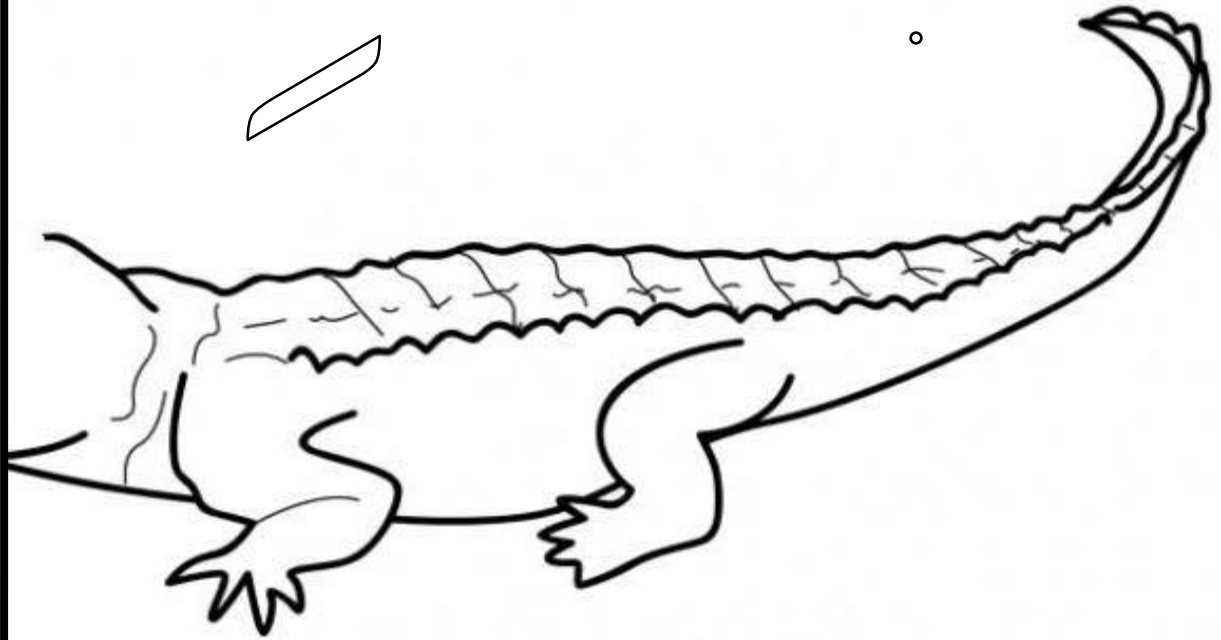
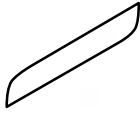
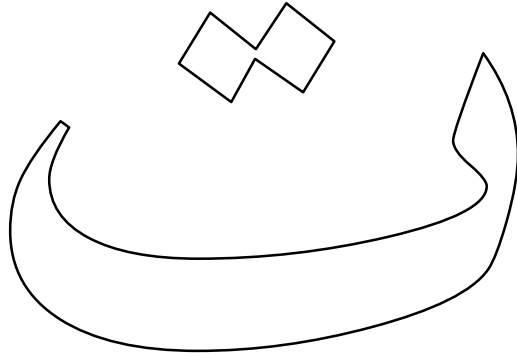

ت ت ت ت ت ت ت

ت ت ت ت ت ت ت



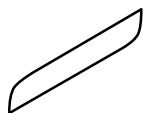
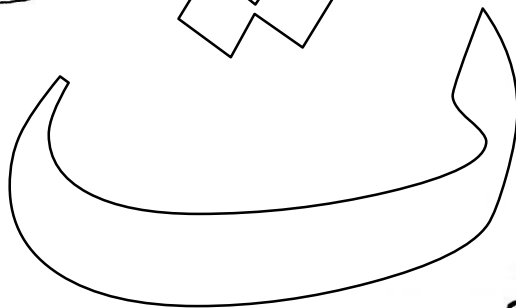

ث ث ث ث ث ث ث

ث ث ث ث ث ث ث

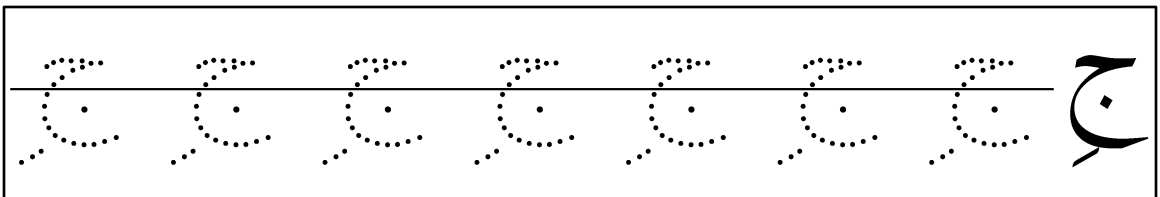
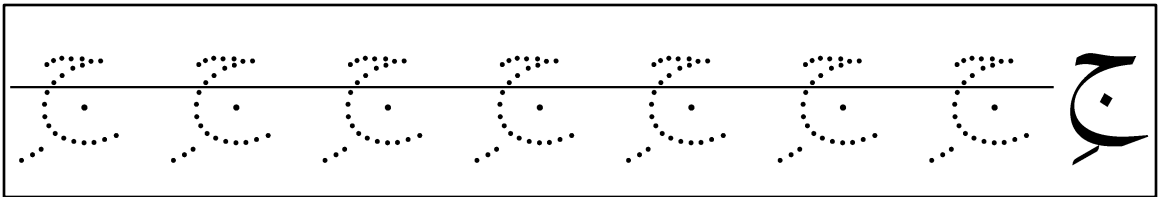
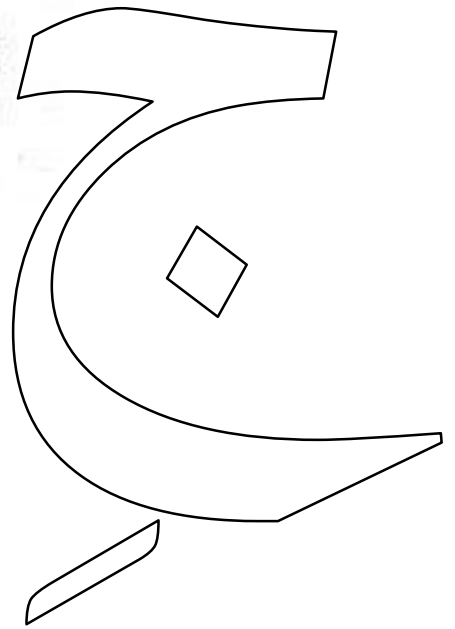
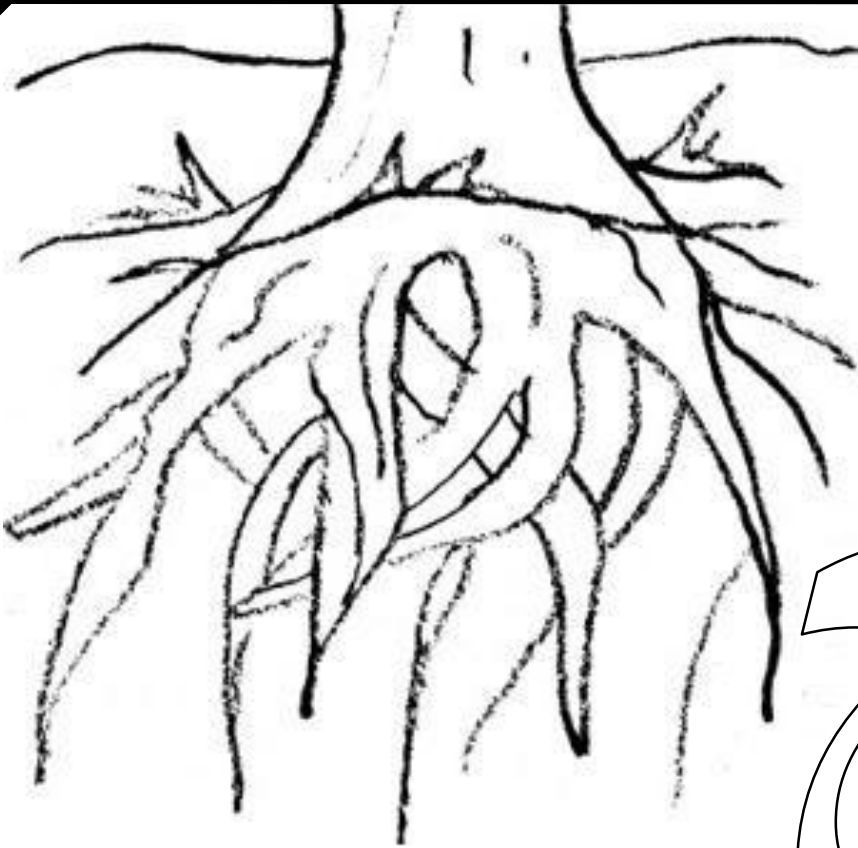

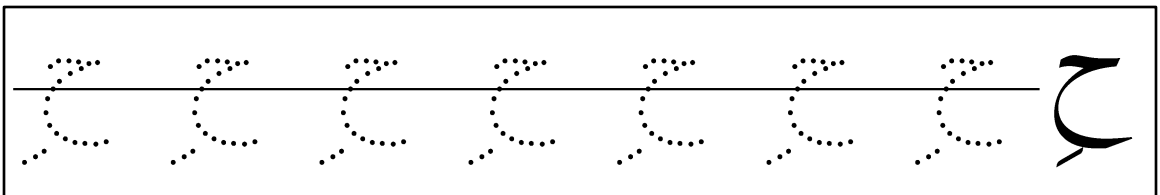
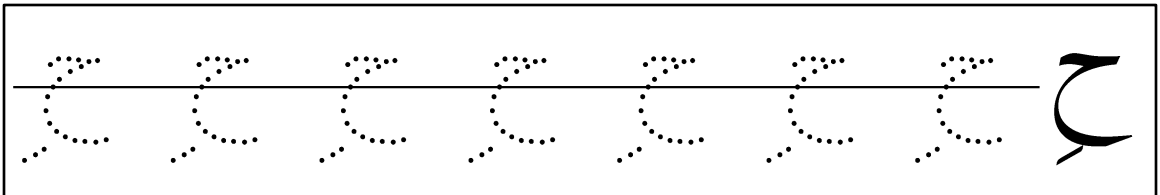
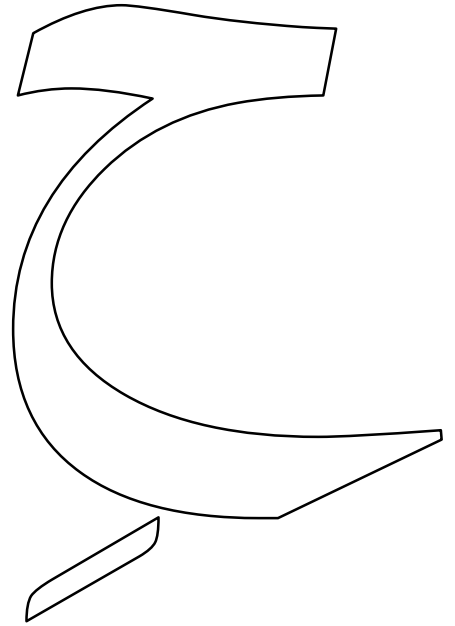

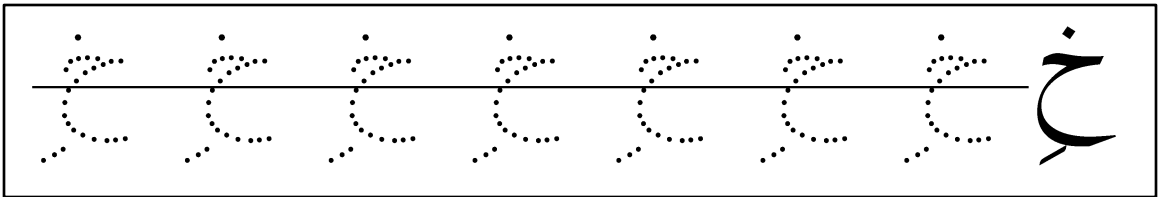
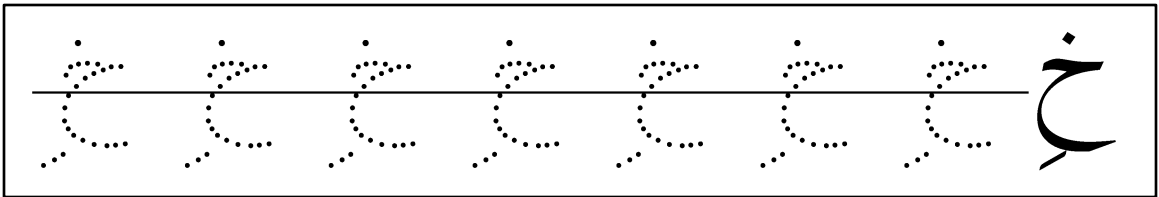
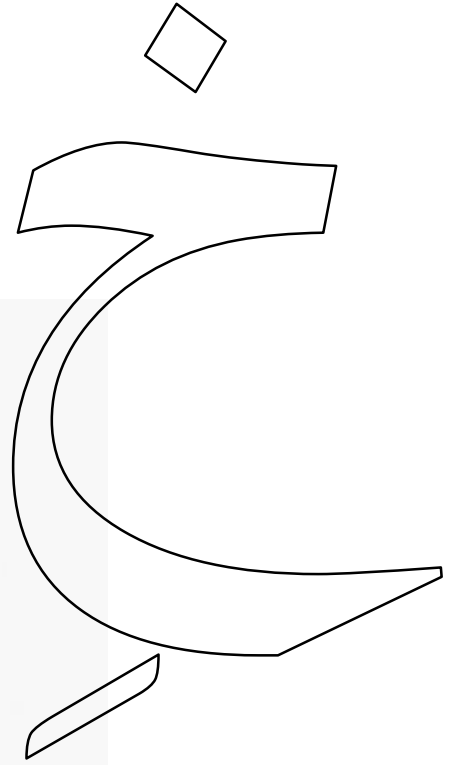
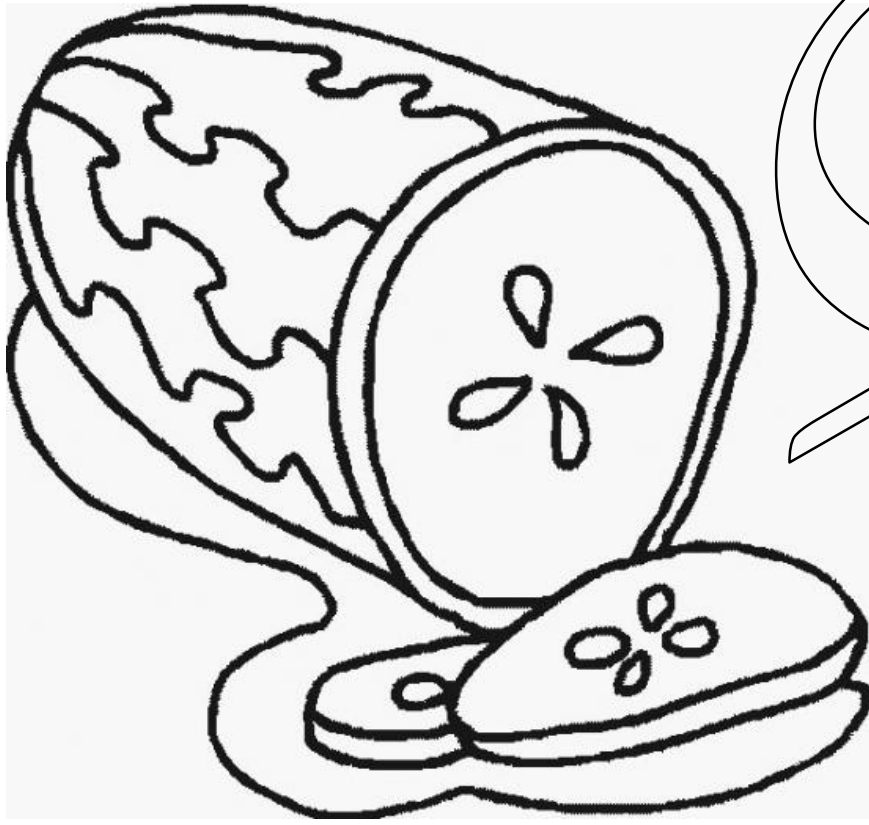

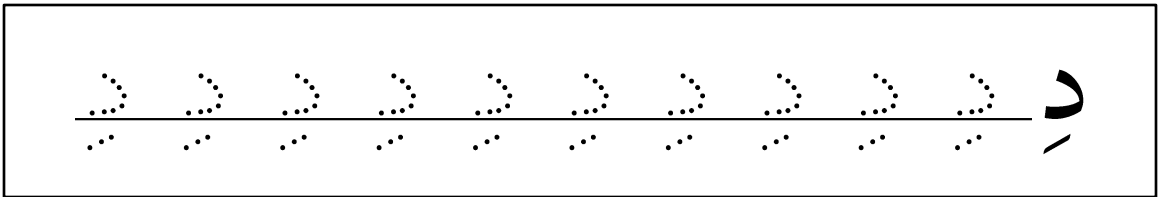
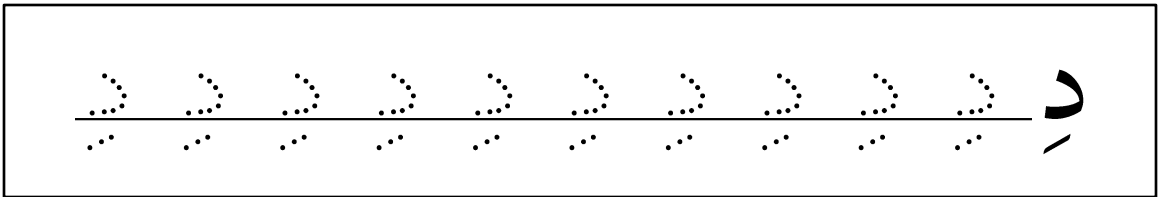
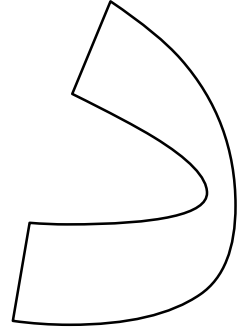

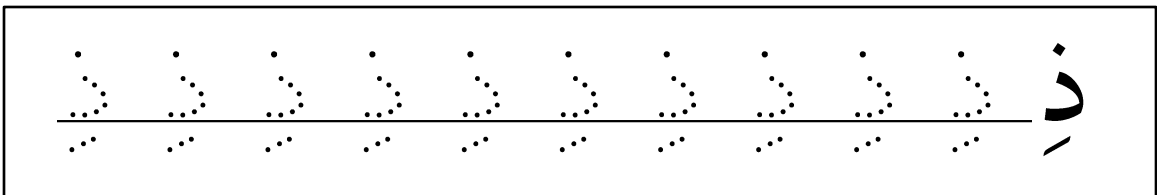
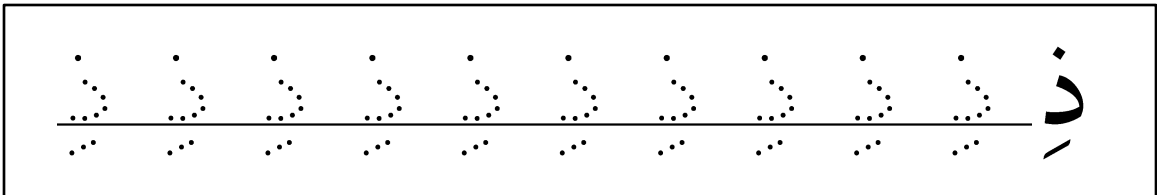
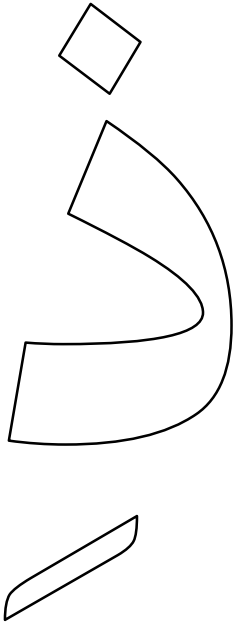
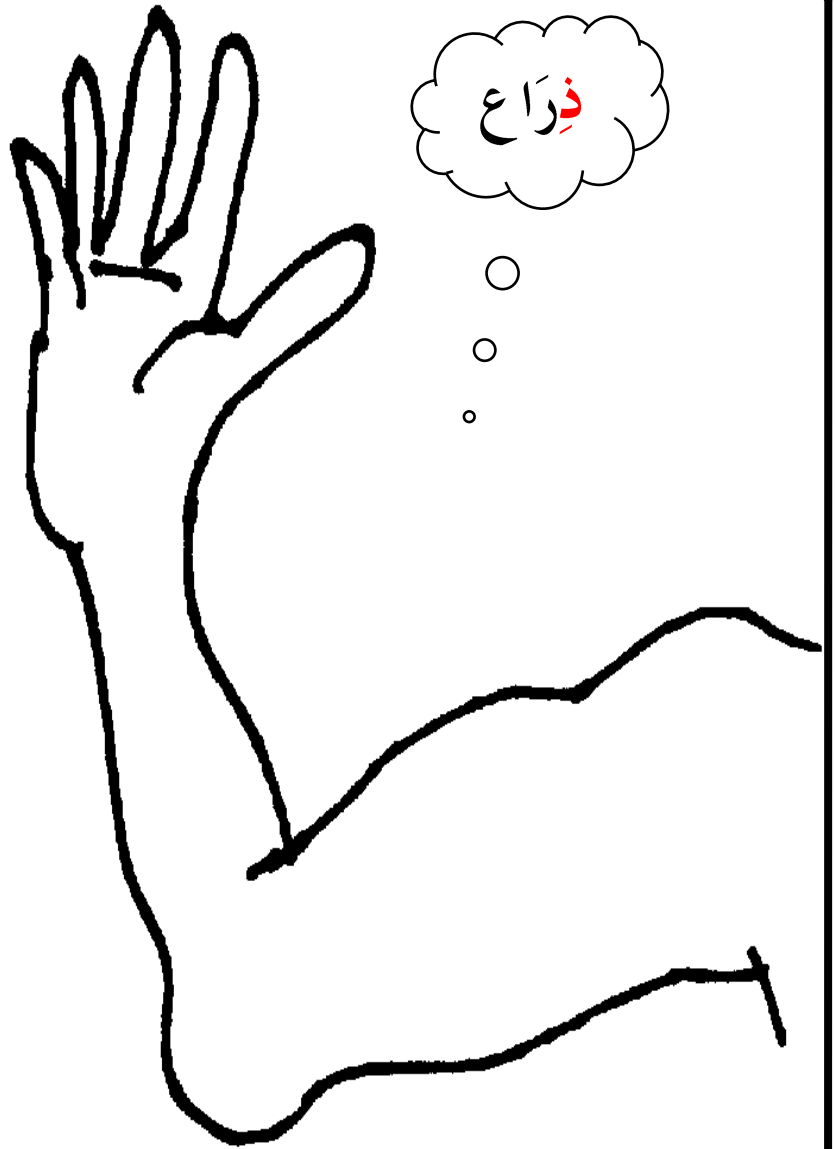

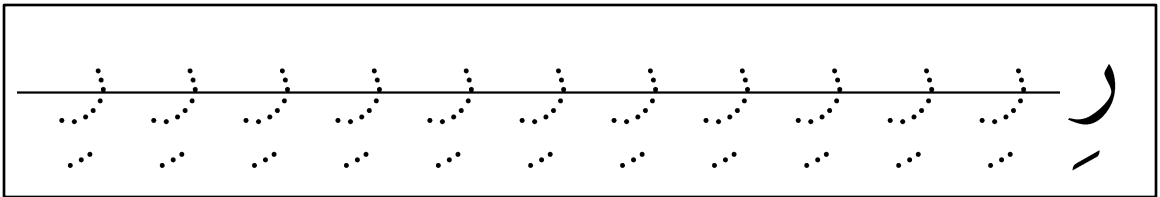
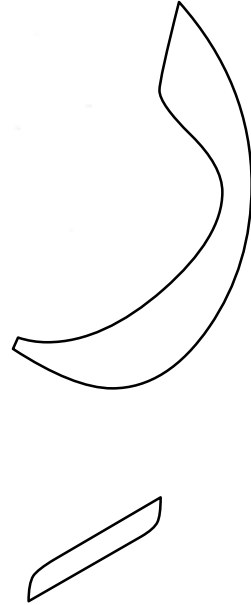

زِيَارَةُ الْمَرِيضِ



ز ز ز ز ز ز ز ز ز ز

ز ز ز ز ز ز ز ز ز ز



6

س

س



س

س س س س س س س

س س س س س س س

شِتَاء



شِ شِ شِ شِ شِ شِ شِ

شِ شِ شِ شِ شِ شِ شِ

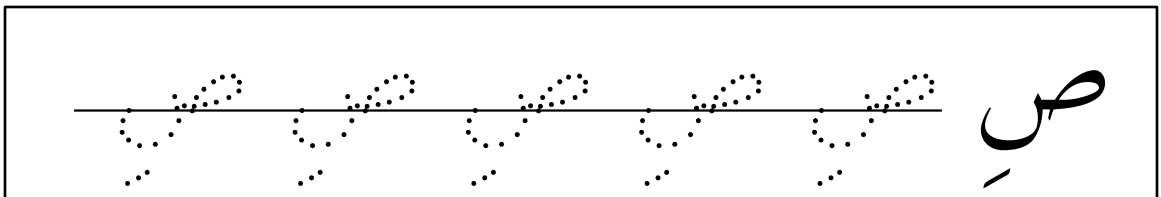
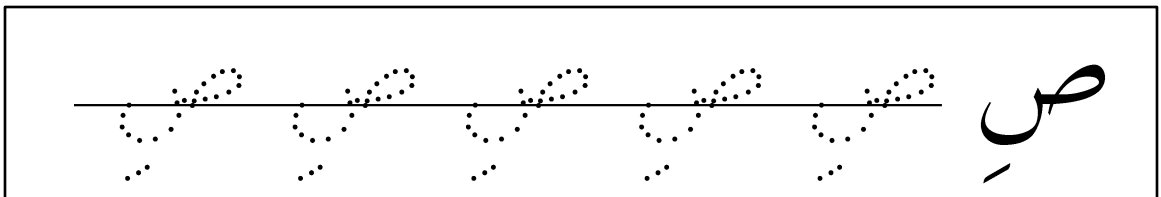
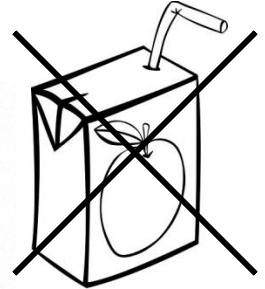
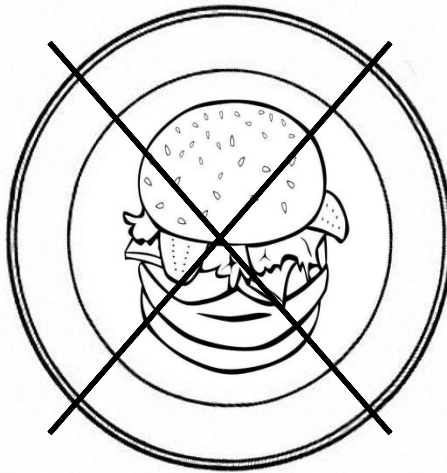
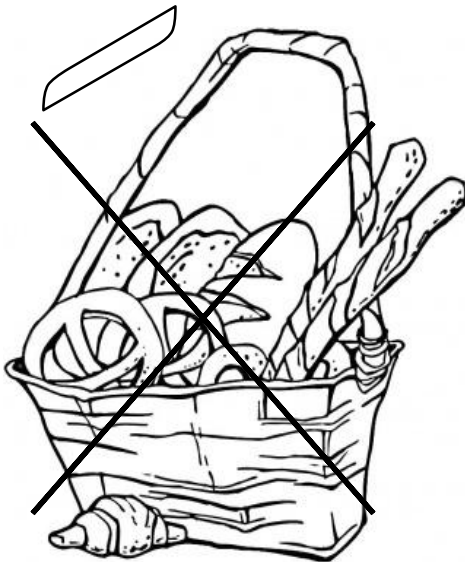
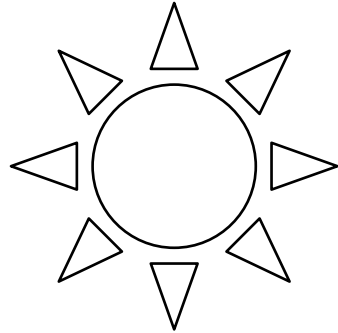
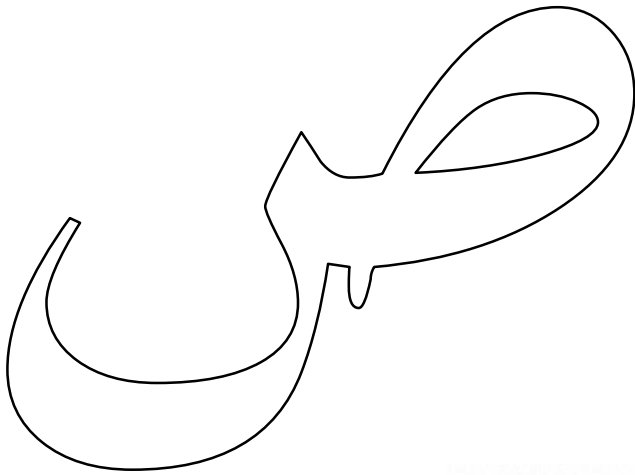

ط

طفل



ط ط ط ط ط ط ط ط ط ط

ط ط ط ط ط ط ط ط ط ط



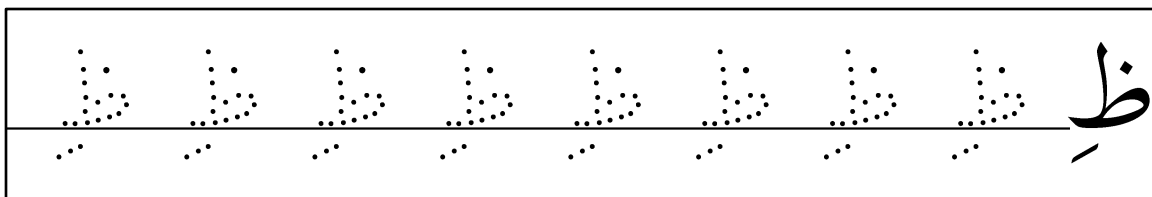
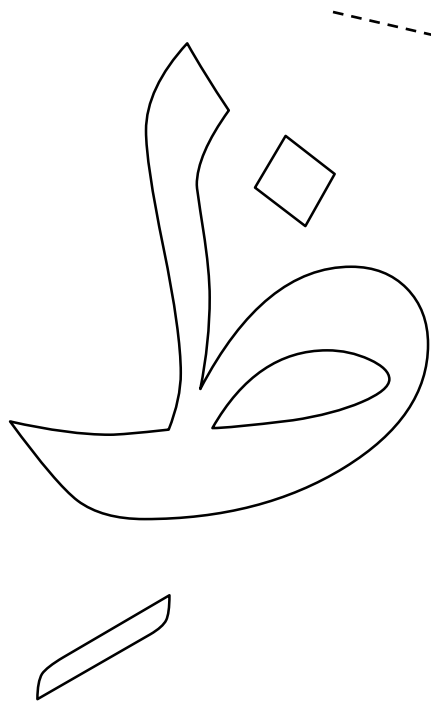

غلاف

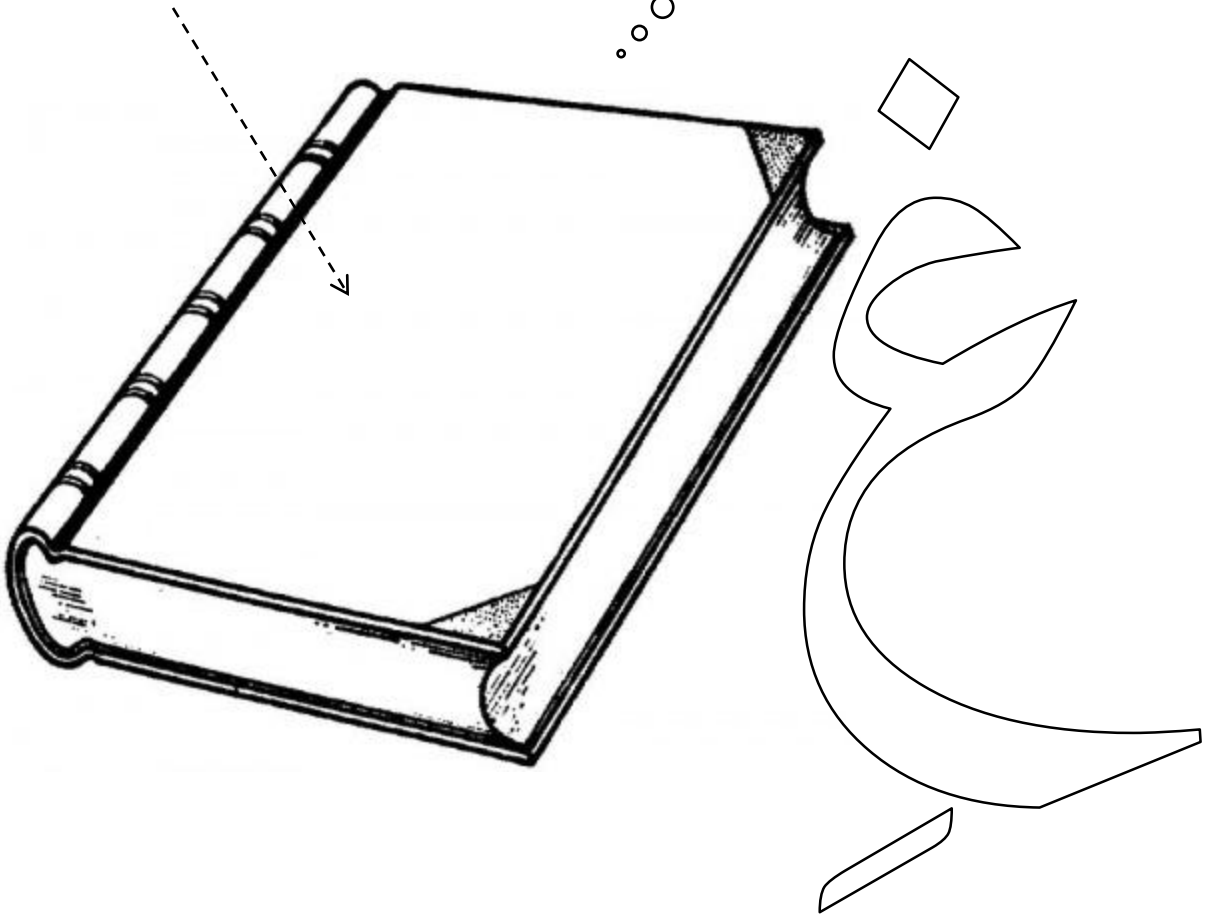

غ غ غ غ غ غ غ غ

غ غ غ غ غ غ غ غ



؟ الله أين

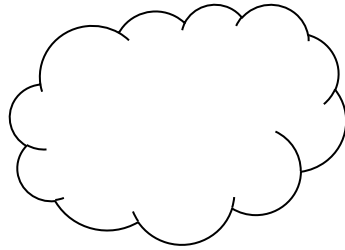
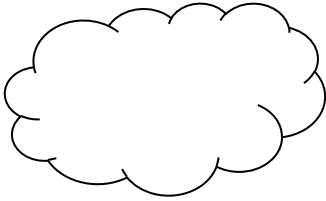

في السماء

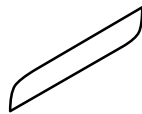
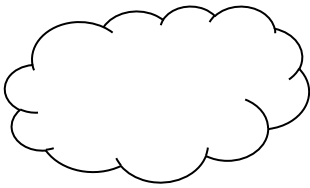
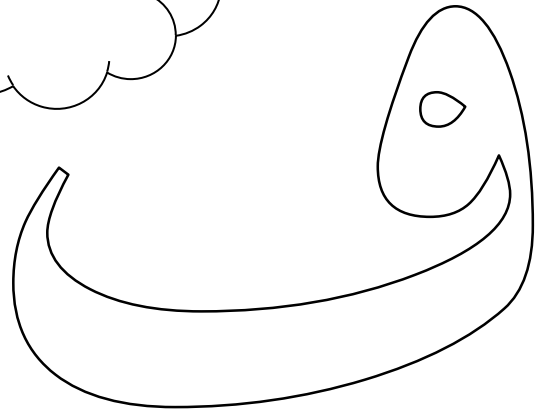

ف ف ف ف ف ف ف

ف ف ف ف ف ف ف



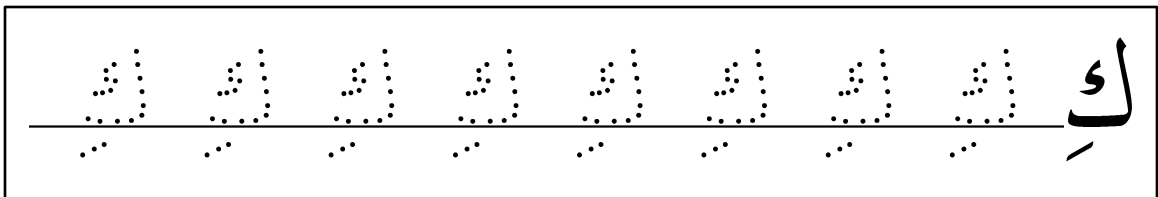
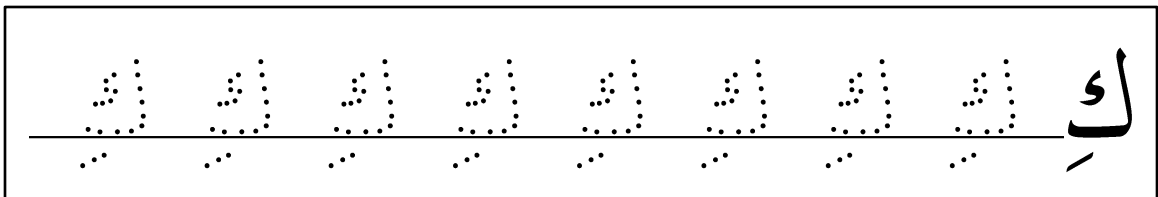
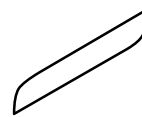
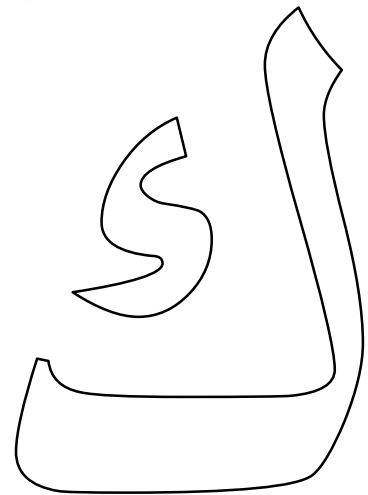
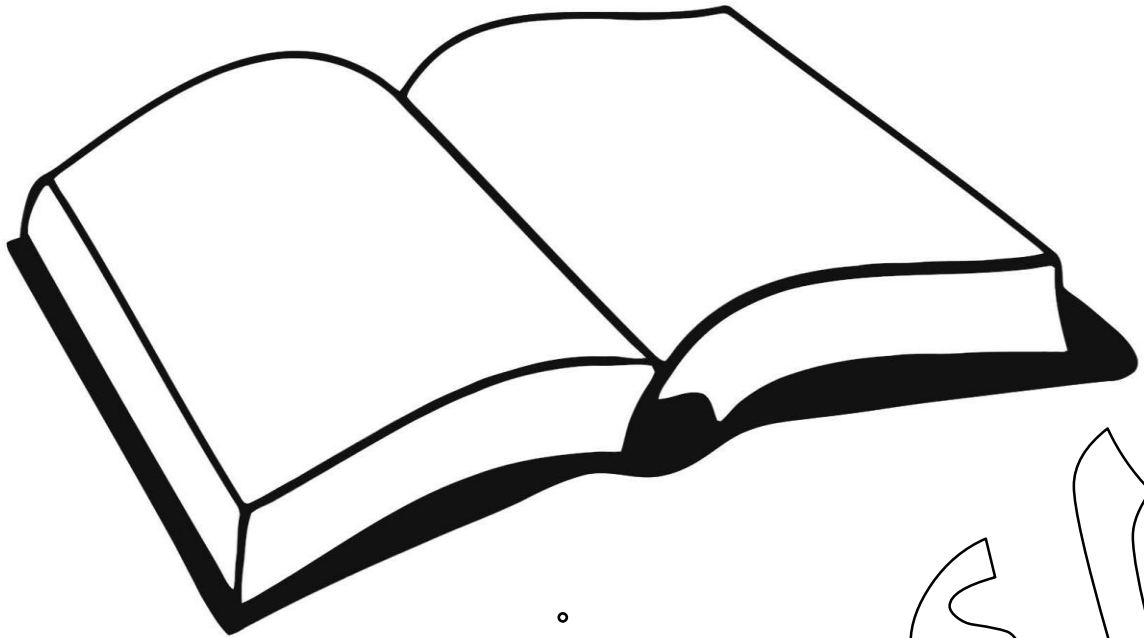

لسان

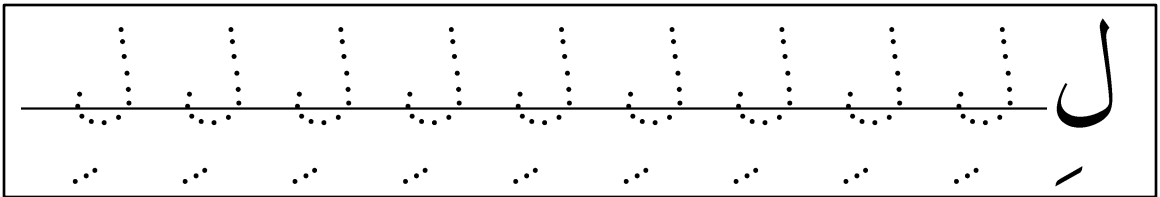
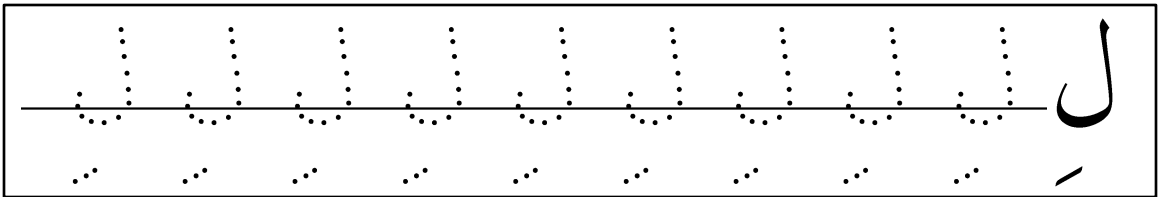
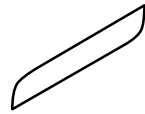
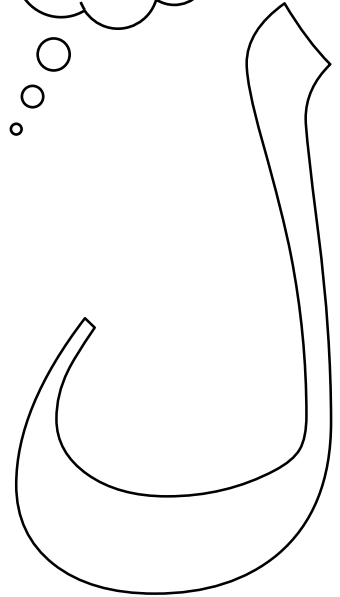
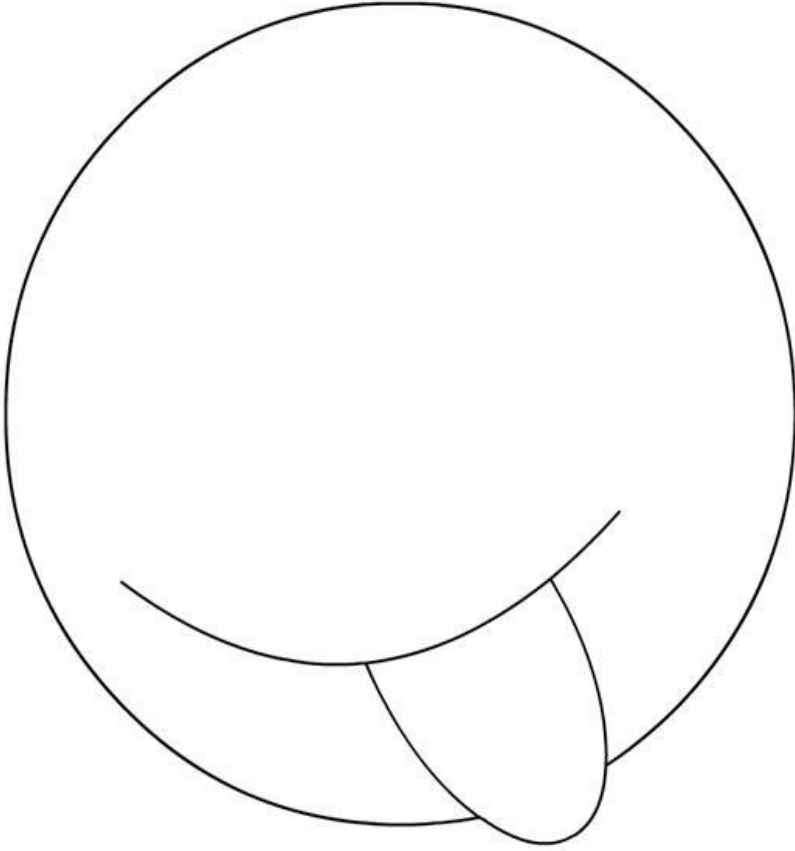

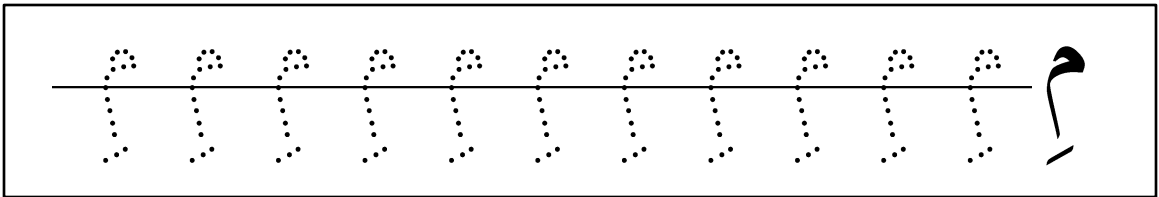
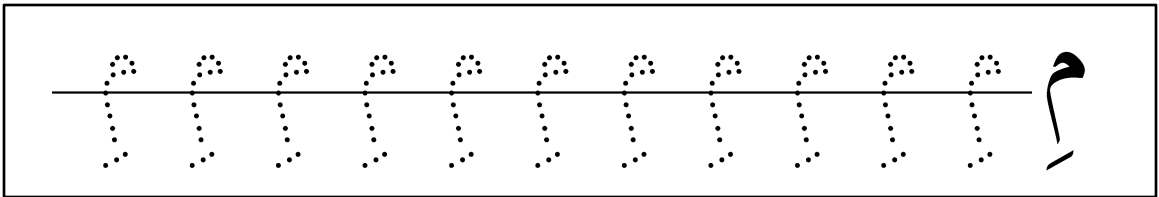
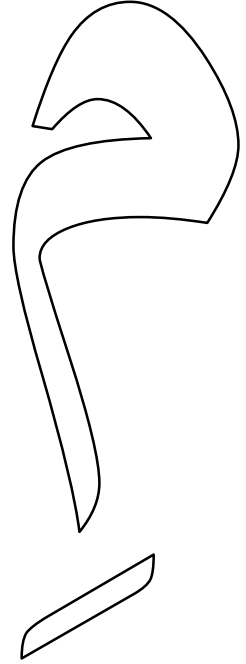
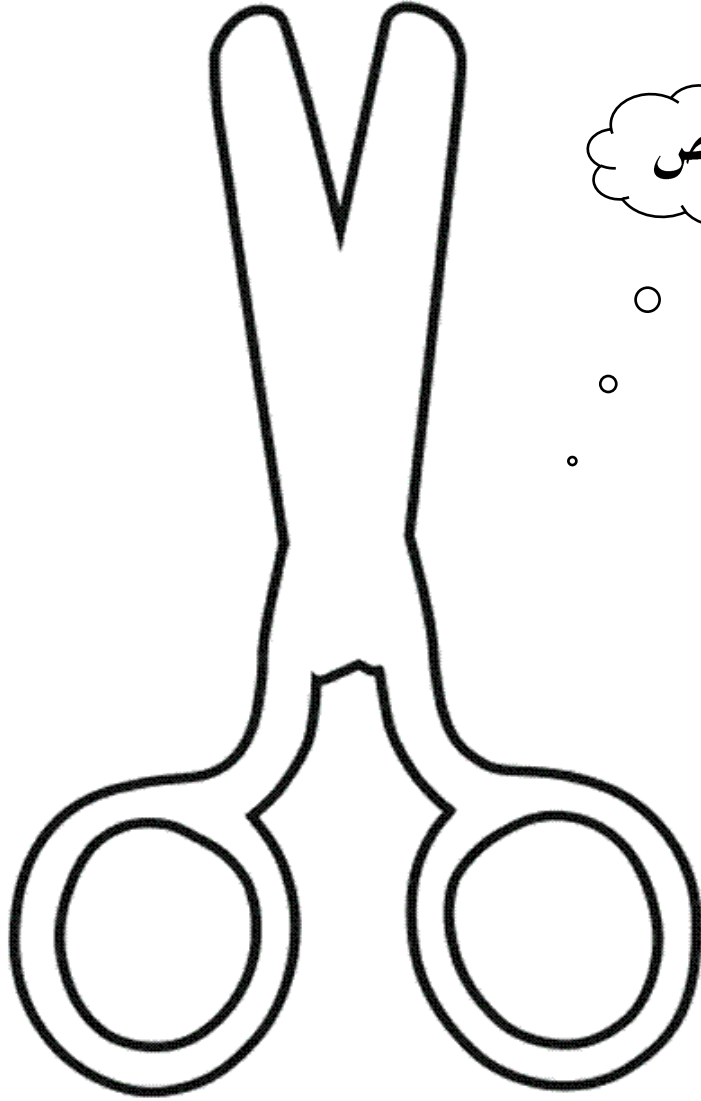

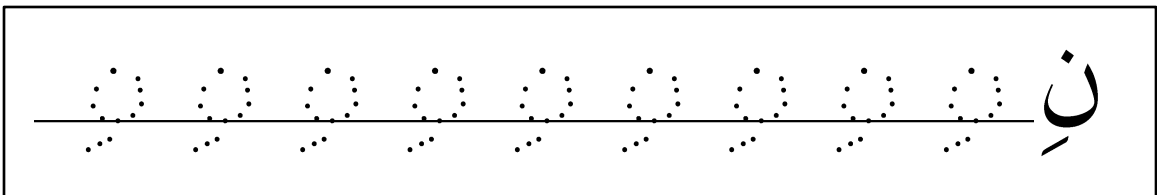
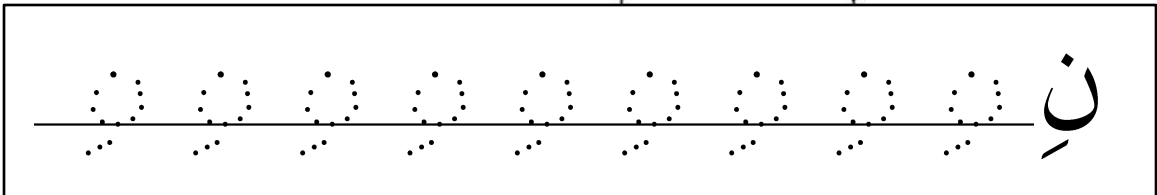
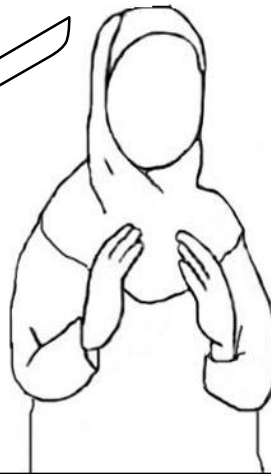
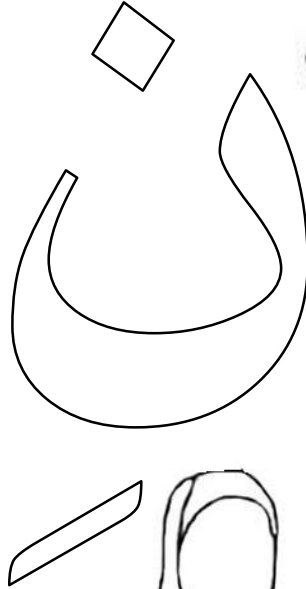
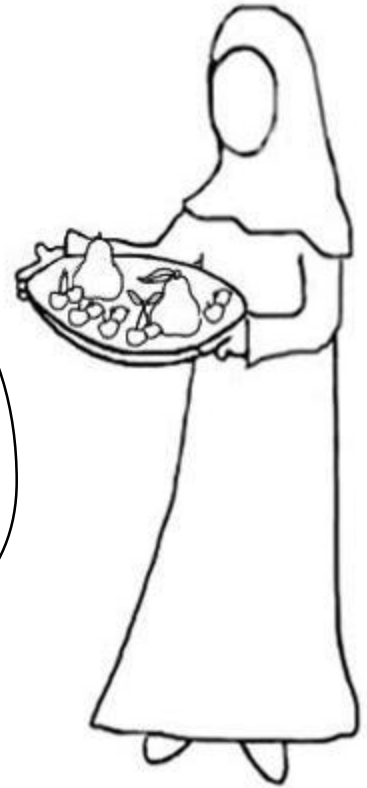

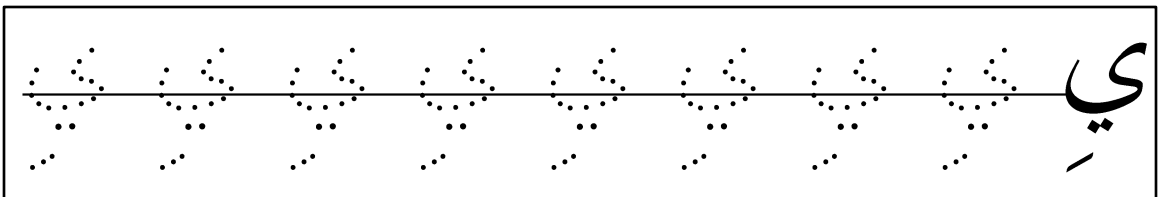
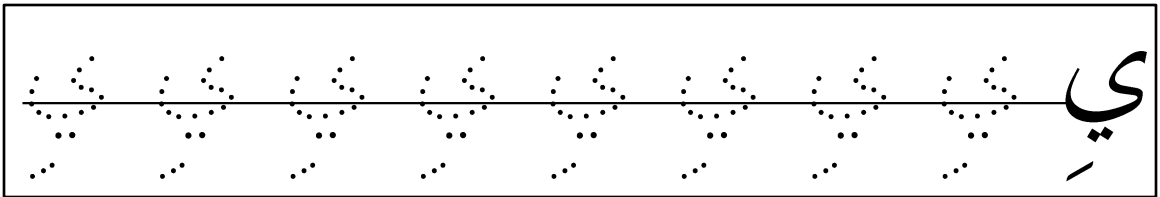
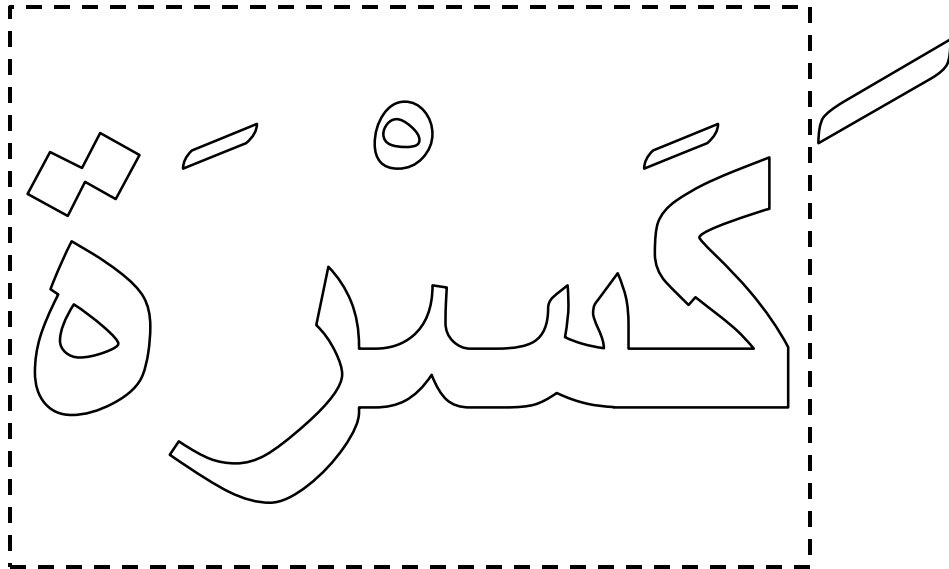
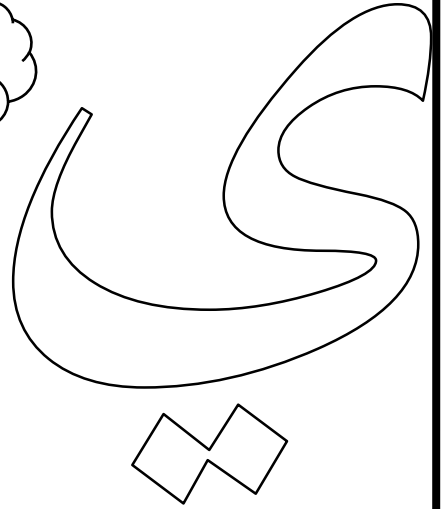
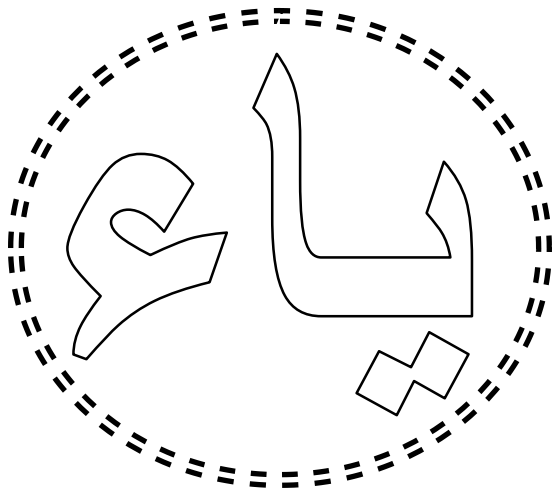



@Arabic_Books