



مدونة المناهج السعودية

<https://eduschool40.blog>

الموقع التعليمي لجميع المراحل الدراسية

في المملكة العربية السعودية

Aa

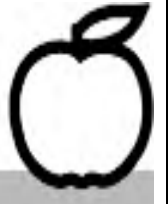

A A A A A A A

a a a a a a a a a a a

Aa Aa Aa Aa Aa

Aa

apple apple apple apple

apple

Aa



1-Colour and say:

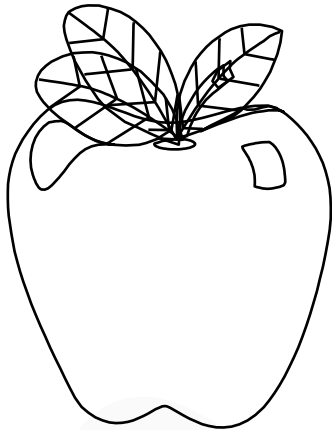

Apple



Ant

FUN ZONE

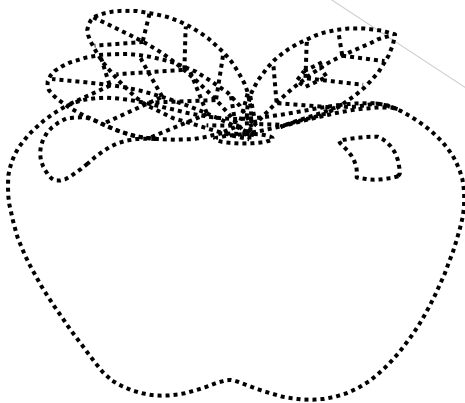

Apple

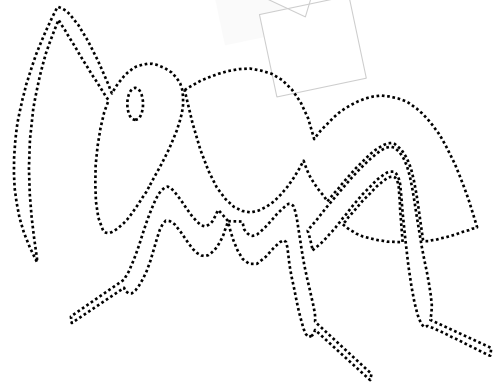

Ant

Aa

Bb



B B B B B B B B

b b b b b b b b b b

Bb Bb Bb Bb Bb Bb

Bb

ball ball ball ball

ball

Bb



2-Colour and say:

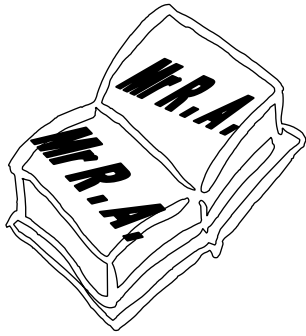

book

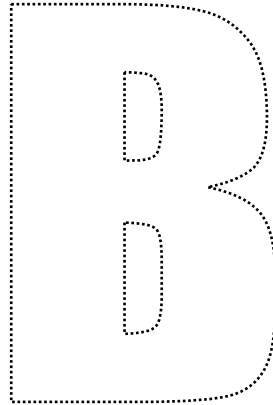

boy

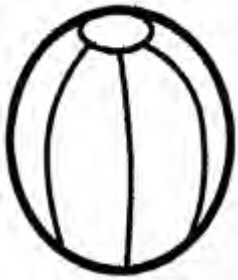

ball

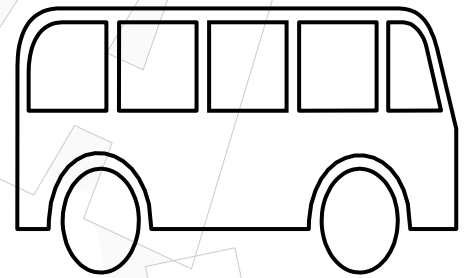
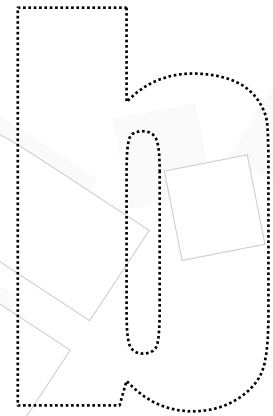

bus

FUN ZONE

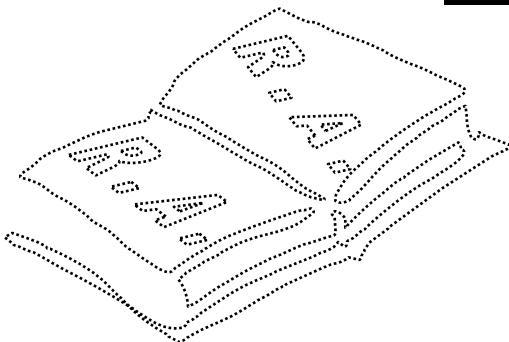

book

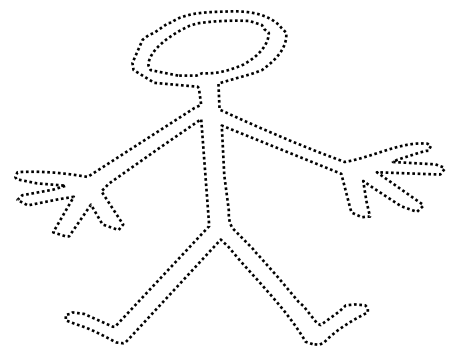

body

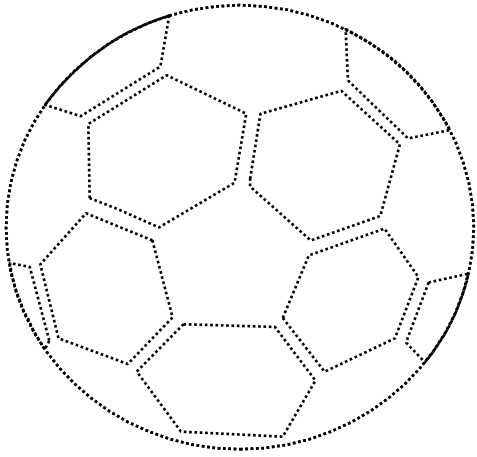

ball

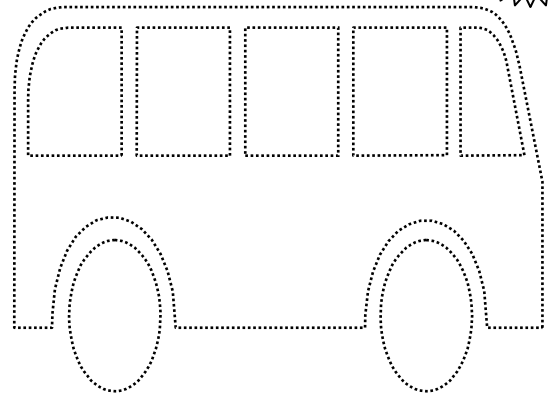

bus

1-Match the words with the pictures:

1- ball

2- apple

3- ant

4- book

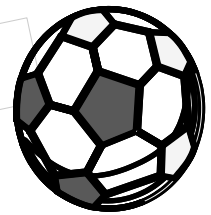
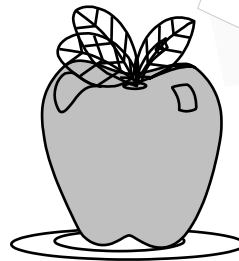

2-Write the first letter under each picture :

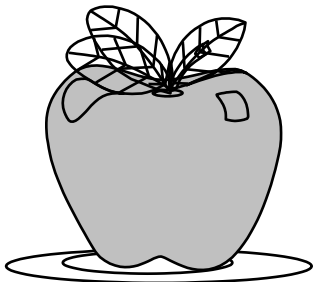

.....



.....

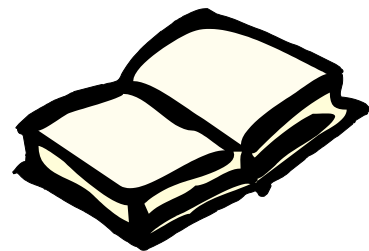

.....

Cc



C C C C C C C C

c c c c c c c c c c c c

Cc Cc Cc Cc Cc Cc

Cc

cat cat cat cat cat cat

cat

Cc

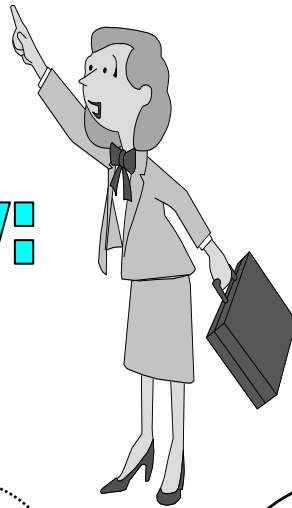

3-Colour and say:



car



cat



camera

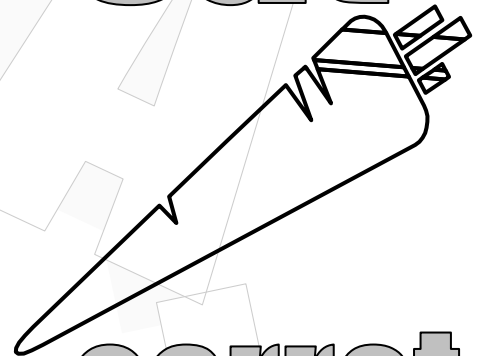
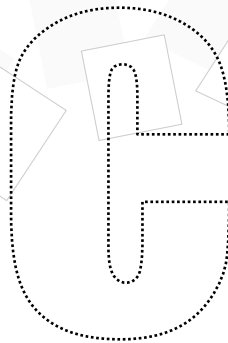

carrot

FUN ZONE

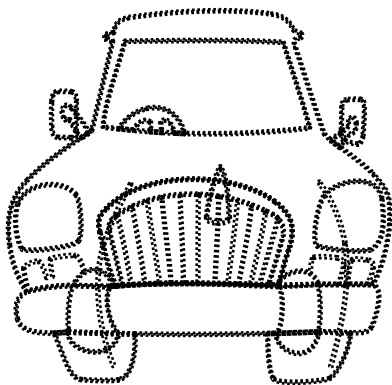

car

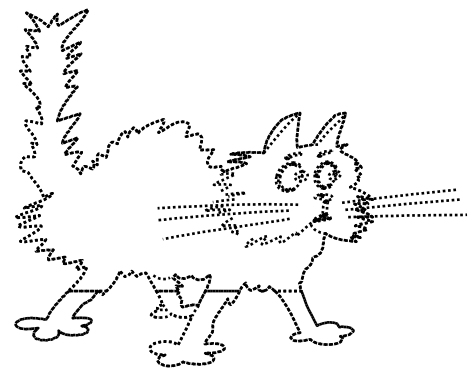

cat

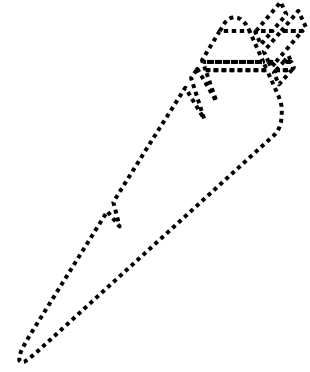
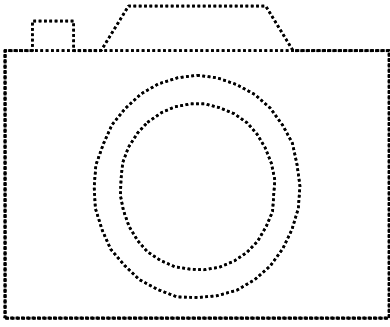

camera

carrot

1-Match the words with the pictures:

1- car

2- cat

3- camera

4- boy

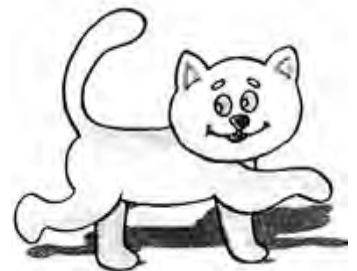

Dd



D D D D D D D

d d d d d d d d d d

Dd Dd Dd Dd Dd Dd

Dd

duck duck duck duck

duck

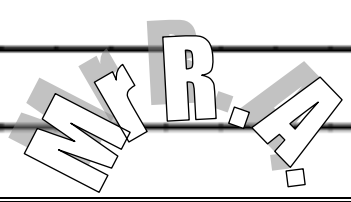

Dd



4-Colour and say:

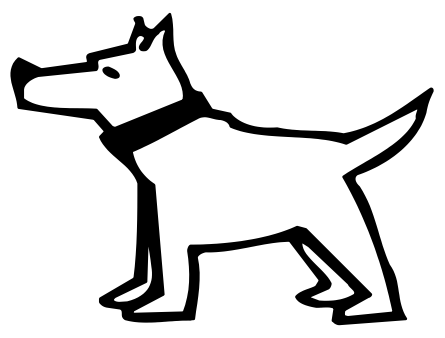

dog

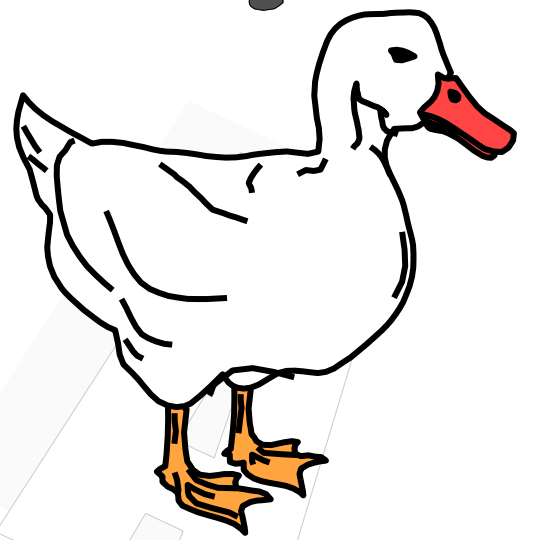
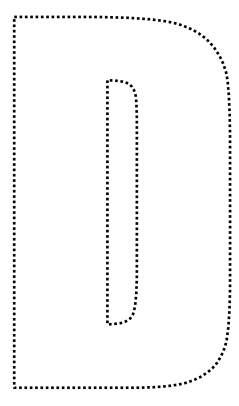

duck



dish

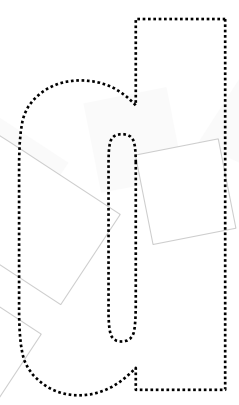

FUN ZONE

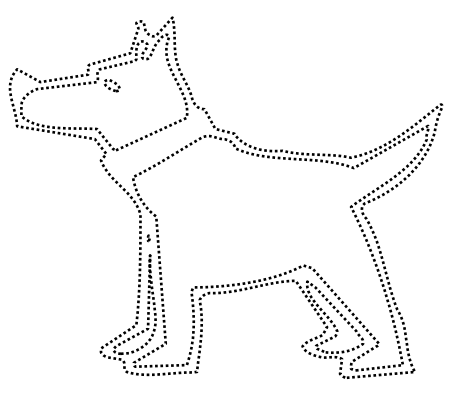

dog

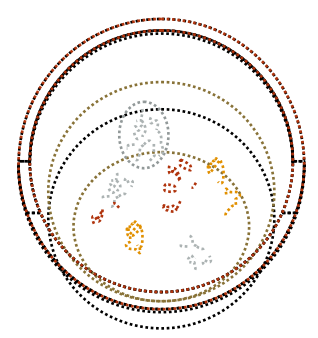

dish

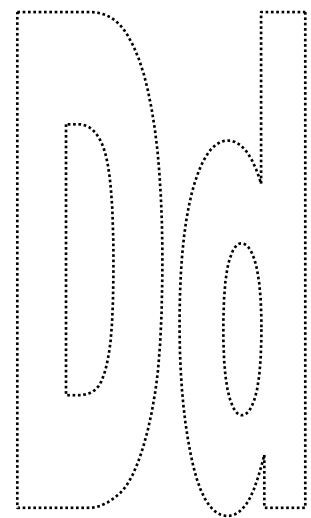
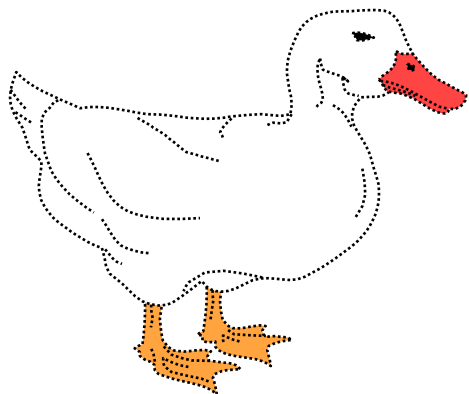

duck

1 -Write the first letter under each picture :

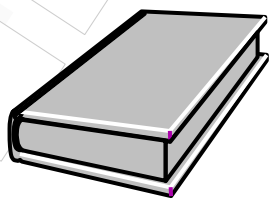
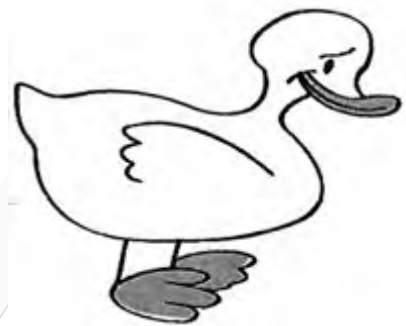
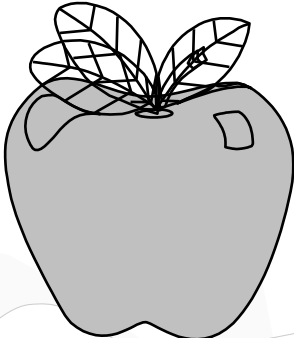

.....

.....

2-Write the capital letters for the following small letters :

a

b

c

d

.....

.....

.....

.....

Ee

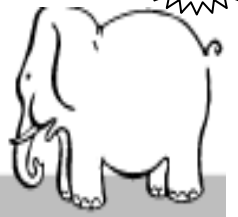

E E (with stroke order arrows) E E E E E E

e e (with stroke order arrows) e e e e e e e e e e

Ee Ee Ee Ee Ee Ee

Ee

elephant elephant

elephant

Ee



4-Colour and say:

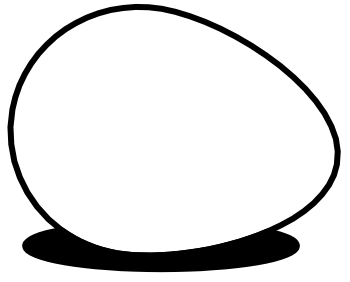

egg

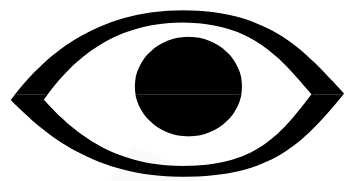
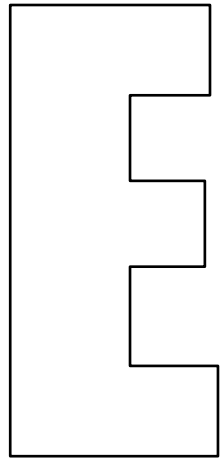

eye

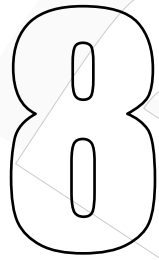

eight

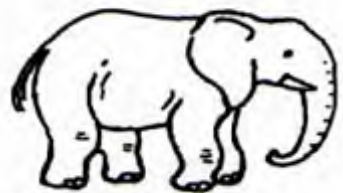
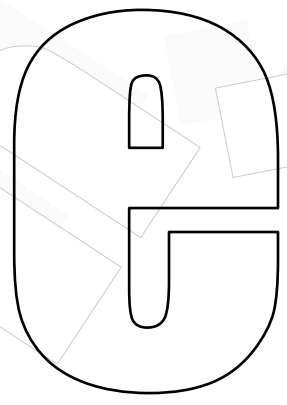

elephant

FUN ZONE

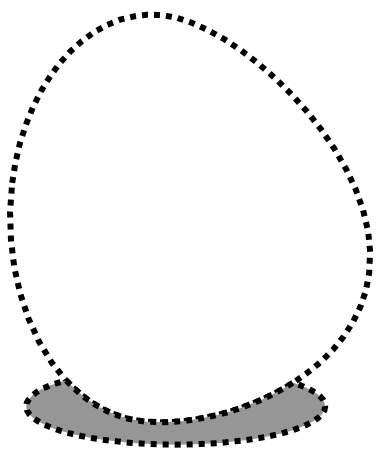

egg

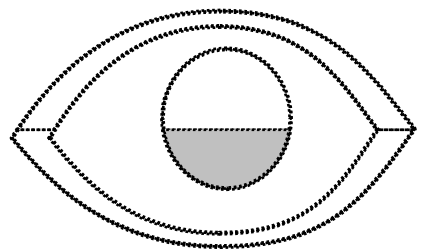

eye

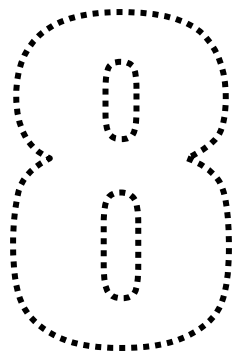

eight

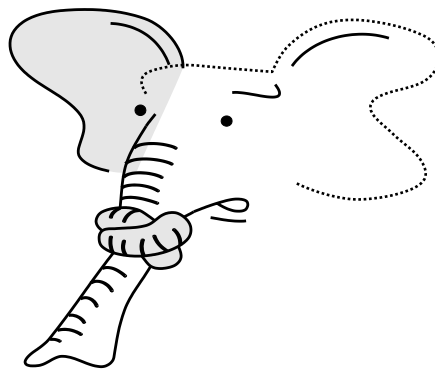

elephant

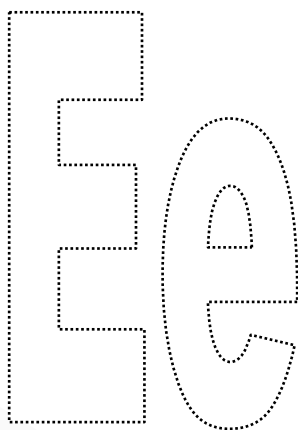

1 -Write the small letters for the following capital letters :

A

B

C

D

E

2- Circle the different picture:

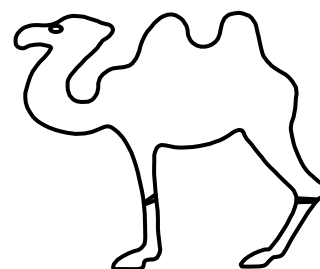

Ff



F F (with stroke order arrows: 1 down, 2 right, 3 right) F F F F F F F F

f f (with stroke order arrows: 1 curve down, 2 right) f f f f f f f f f f

Ff Ff Ff Ff Ff Ff Ff Ff

Ff Ff Ff Ff Ff Ff Ff Ff

fish fish fish fish fish fish fish fish

fish fish fish fish fish fish fish fish

Mr R.A.

Ff



6-Colour and say:

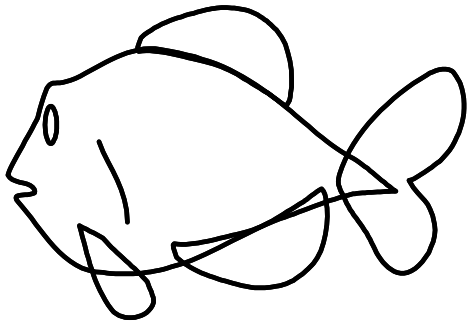

F

5

fish

f

five

FUN ZONE

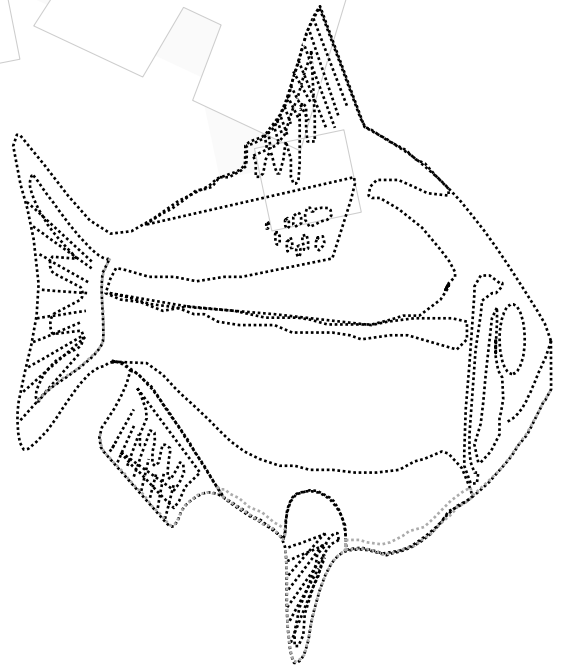
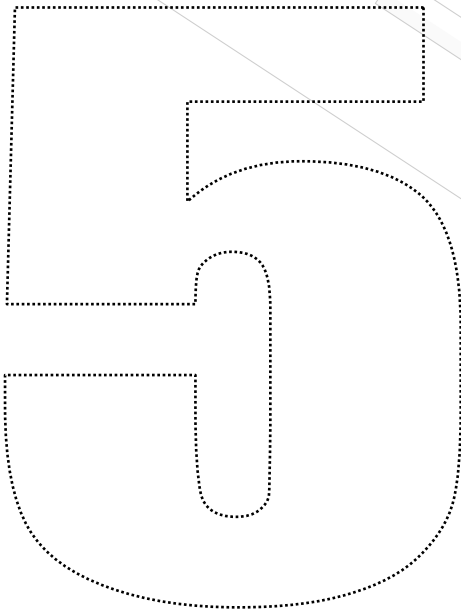

five

fish

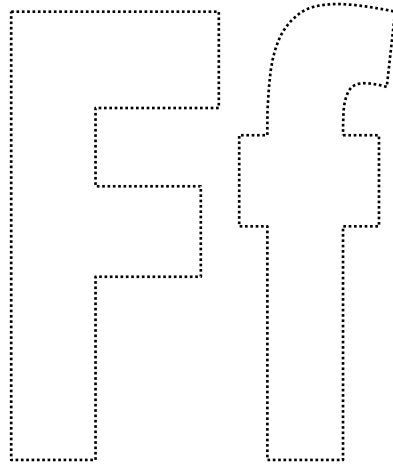

1- Complete the following letters :

Aa

...b

Cc

D....

E....

...f

2- Listen and circle the right picture :

1.



2.



Gg



Gg

G G G G G G G

g g g g g g g g g g

Gg Gg Gg Gg Gg

Gg

grapes grapes grapes

grapes

Gg



7-Colour and say:

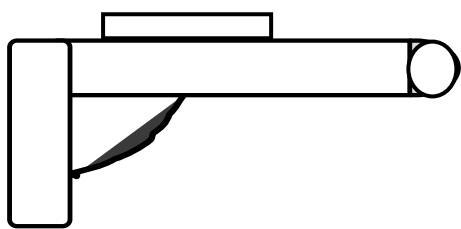

gun



girl

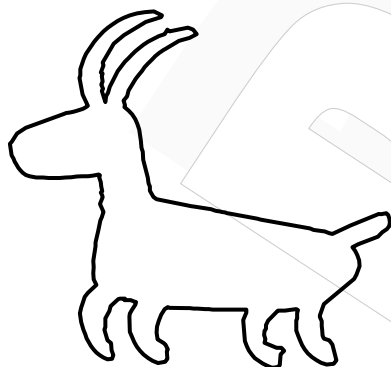

goat

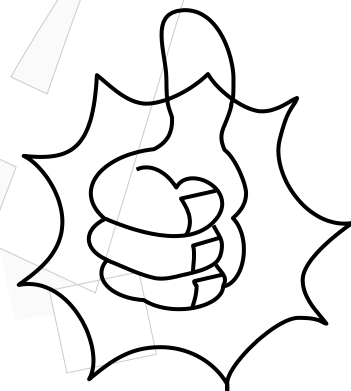
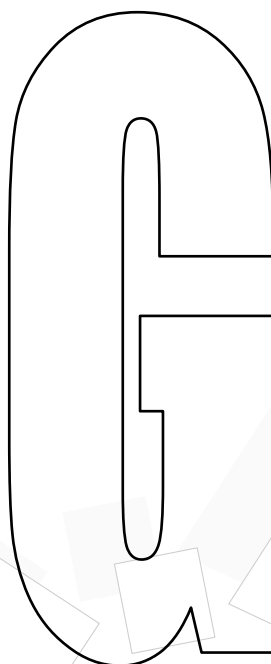

Good.



Goodbye.

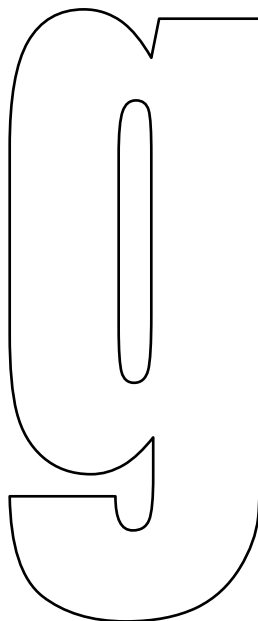

green

Fun Zone

1-Match and colour :

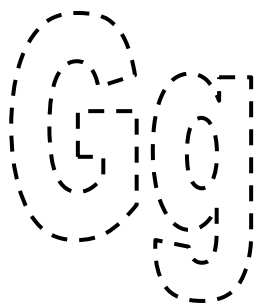
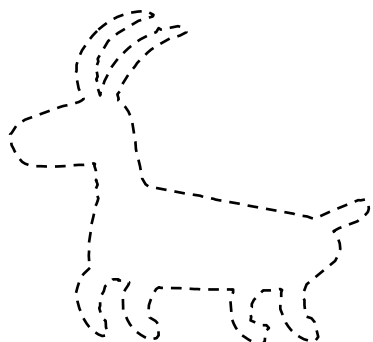

2-Match the words with the pictures:

1- Goodbye

2- G

3- good

4- gun

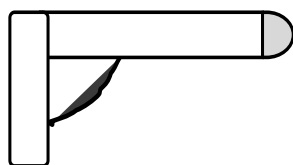
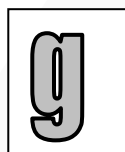

3-Write the first letter under each picture:

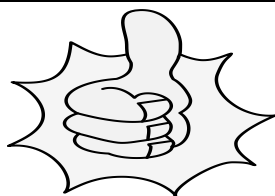
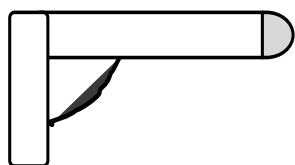

.....

.....

.....

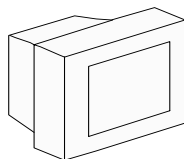

.....

.....

.....

Hh

Hh



H H H H H H H H H H H H H H H H H H

h h h h h h h h h h h h h h h h h h

Hh Hh Hh Hh Hh Hh Hh Hh Hh Hh Hh Hh Hh Hh Hh Hh Hh

Hh

house house house

house

Hh



8-Colour and say:

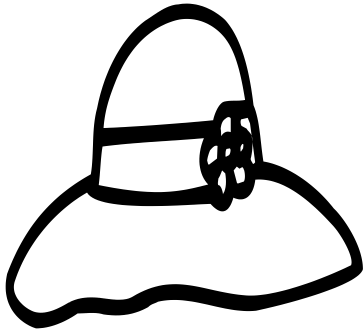

hat

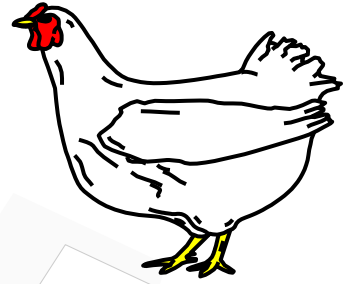
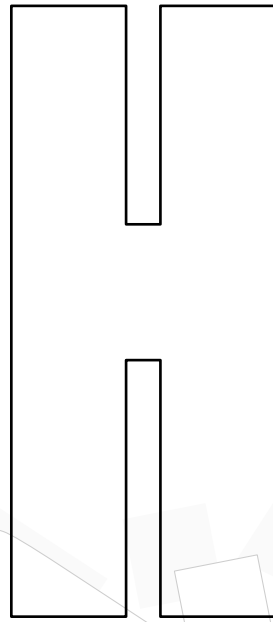

hen



hand

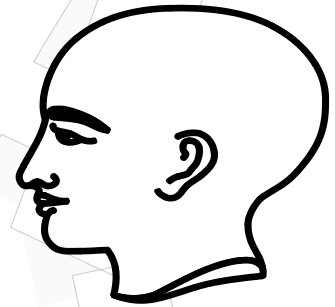

head

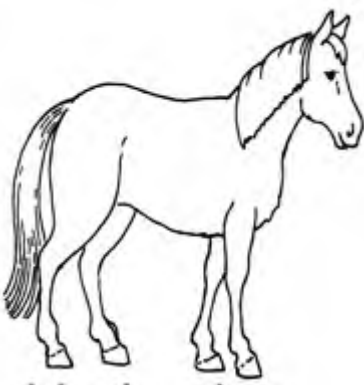

horse

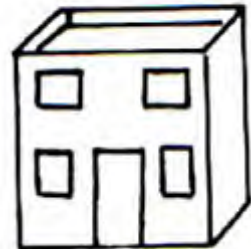
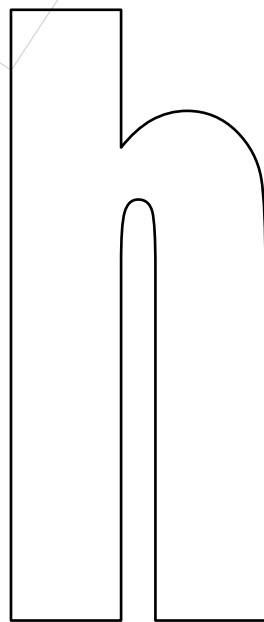





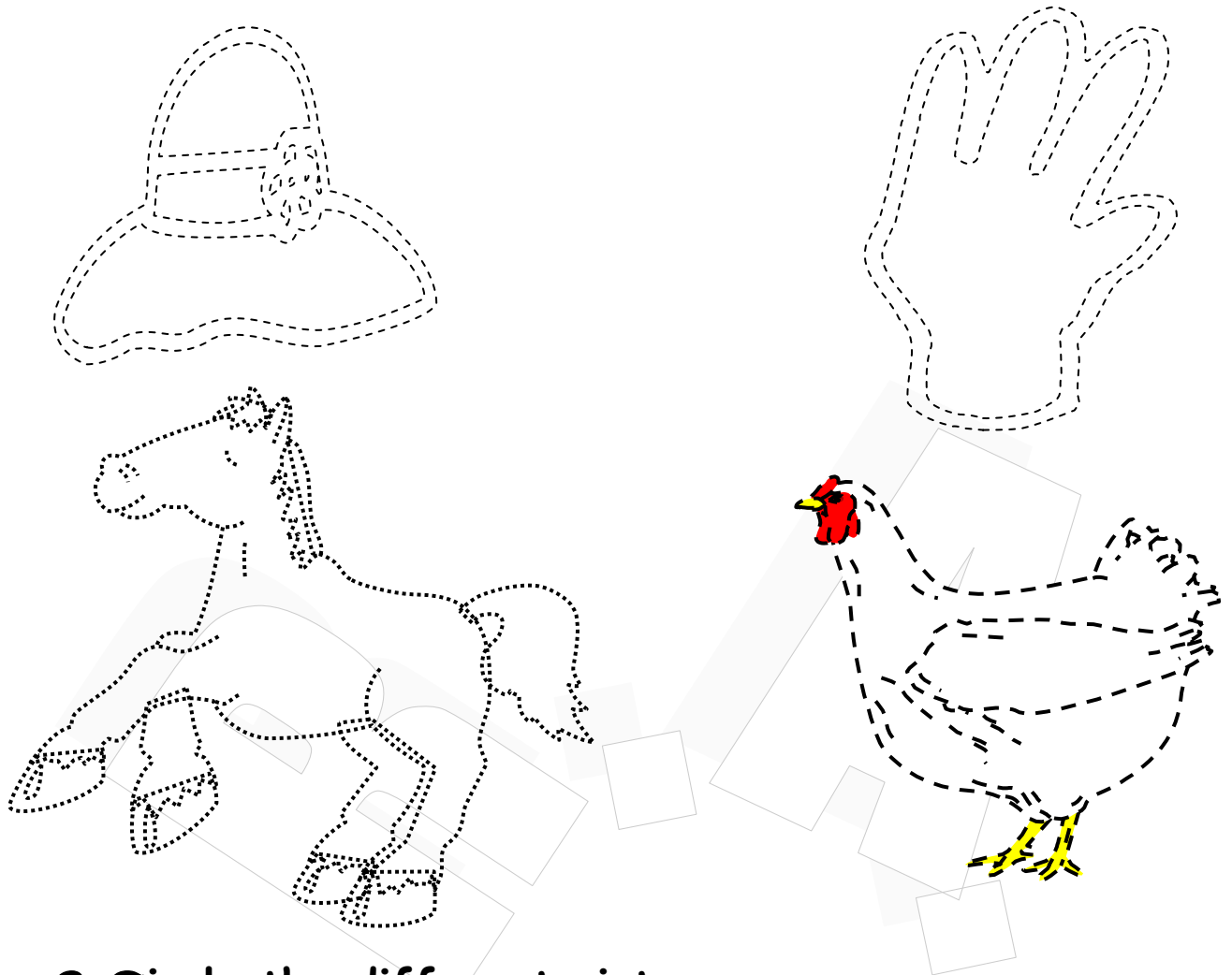

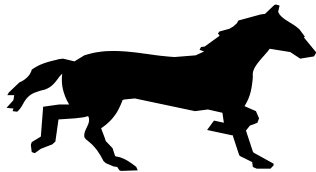

house

1-Match and colour :



2- Circle the different picture:

1-			
2-			
3-			

Ii

Ii



I I I I I I I I I I I I I I I I

i i i i i i i i i i i i i i i i i i

Ii Ii Ii Ii Ii Ii Ii Ii Ii Ii Ii Ii Ii Ii

Ii

ice cream ice cream

ice cream

Ii



9-Colour and say:



I



ice-cream

i

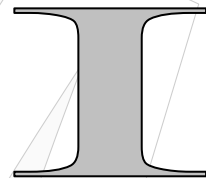
1-Supply the missing letters :

1- ice crea.....

2- appl.....

3- c..t

4- bo.....

5- han.....

6- hors...

2-Match the words with the pictures :

1- car

2- ball

3- I



Jj



Jj

J J J J J J J

j j j j j j j j j j j j j j j j

Jj Jj Jj Jj Jj Jj

Jj

jet jet jet jet jet jet jet

jet

Jj



10-Colour and say:

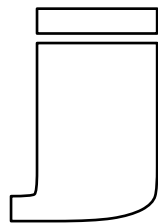
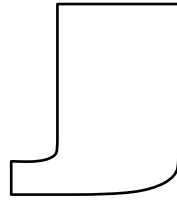

jacket

jump

1-Match the words with the pictures :

1-jump

2-egg

3-hen

4-duck

5- one

6-two



1

2

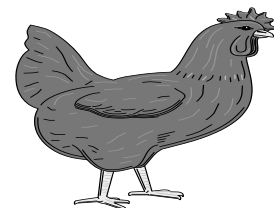

Kk

Kk

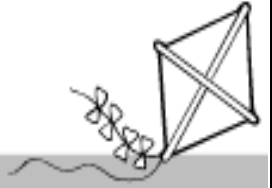

Kk Kk Kk Kk Kk Kk Kk Kk

k k k k k k k k k k k k

Kk Kk Kk Kk Kk Kk Kk Kk

Kk

kite kite kite kite kite

kite

Kk



11-Colour and say:

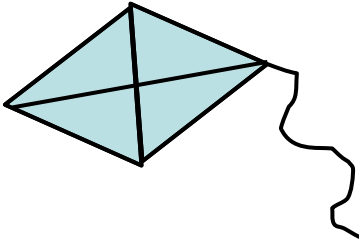

K

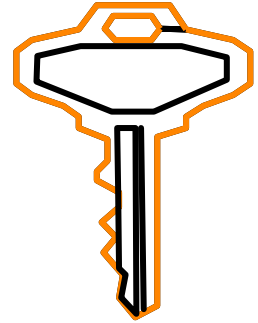

kite

k

key

Fun Zone

1-Match and colour :

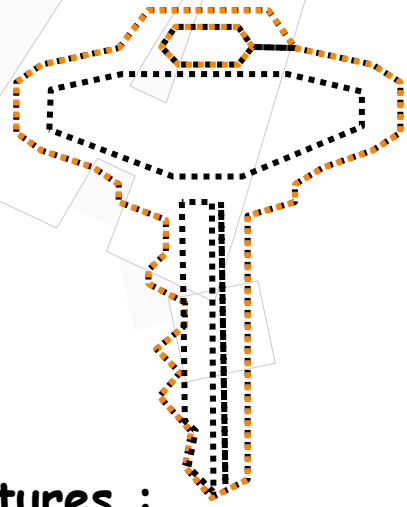
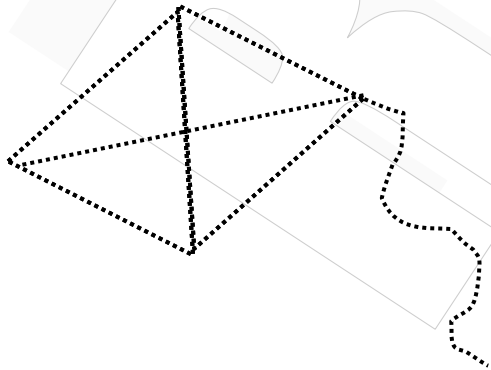

2-Match the words with the pictures :

1-key

2-kite

3-elephant

4-hat

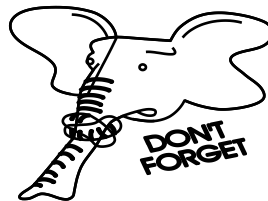
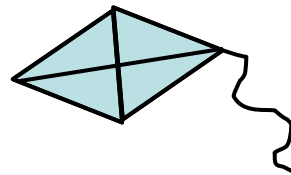

L l



L l

L l L l L l L l L l L l L l

L l L l L l L l L l L l L l L l L l L l L l L l L l L l

L l L l L l L l L l L l L l L l L l L l L l L l L l L l

L l L l L l L l L l L l L l L l L l L l L l L l L l L l

lemon lemon lemon

lemon

LI
12-Colour and say:



lion

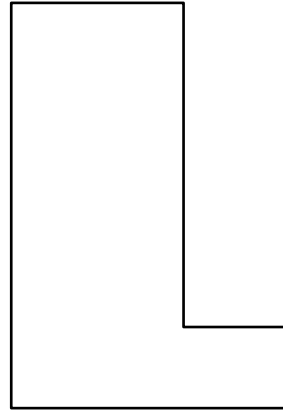

lollipop

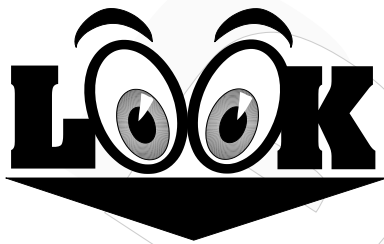

LOOK.

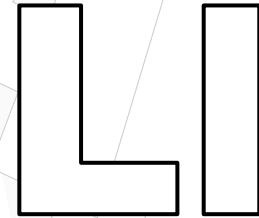
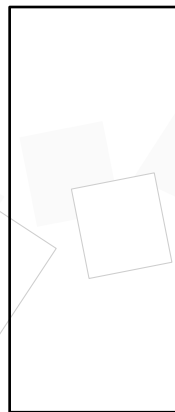

1-Match the words with the pictures :

1- look

2- lion

3- lollipop

4- kite

5-jacket

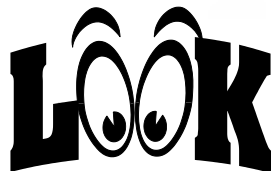

Mm



Mm

M M M M M M M M M M

m m m m m m m m m m

Mm Mm Mm Mm

Mm

mouse mouse mouse

mouse

Mm



13-Colour and say:



monkey

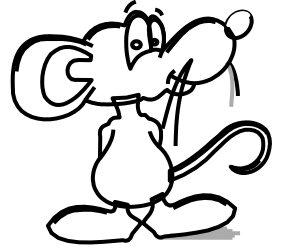
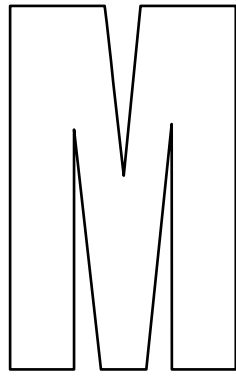

mouse



mother

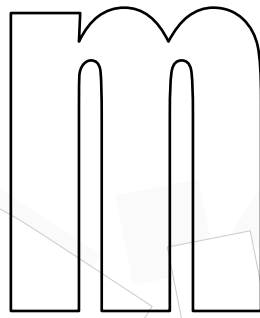

mat

Fun Zone

1-Match and colour :

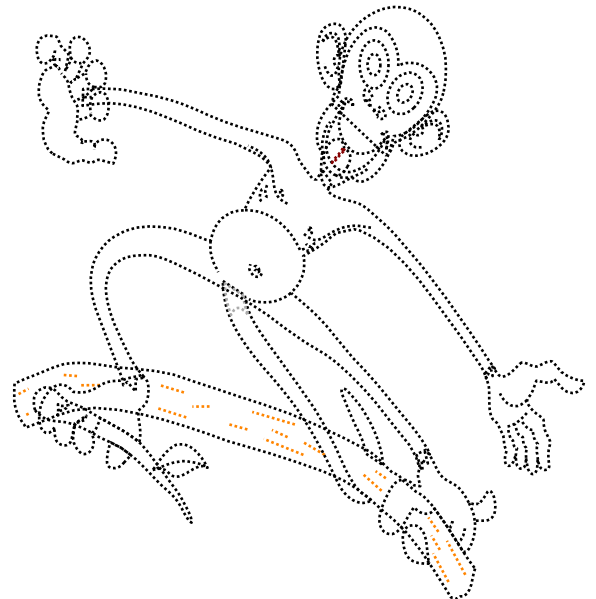
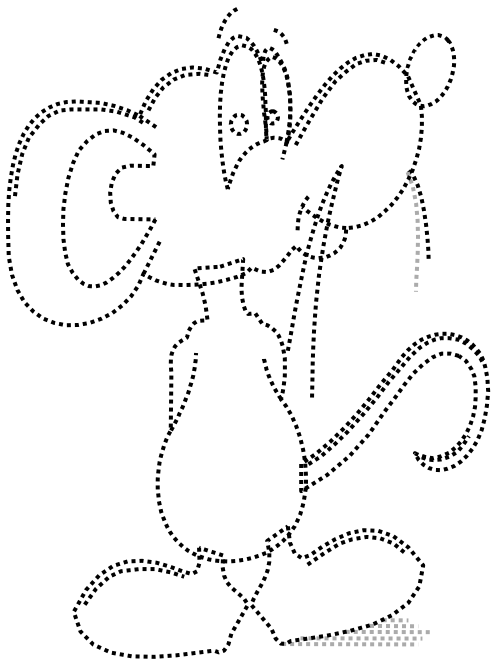

2-Match the words with the pictures:

1-man

2-mother

3-mat

4-moon



3- Write the words under each picture:

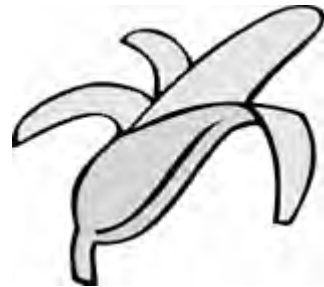
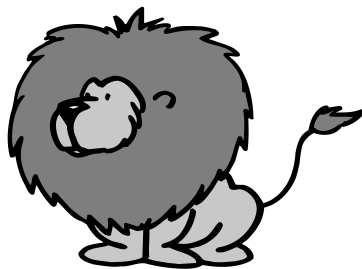
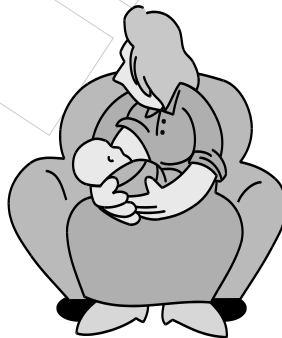
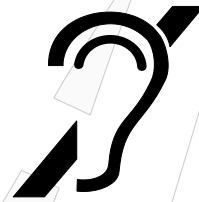

Nn

Nn



N N N N N N N N N N N N N N N N

n n n n n n n n n n n n n n n n

Nn Nn Nn Nn Nn Nn Nn

Nn

nest nest nest nest

nest

Nn

14-Colour and say:



9

nine

N

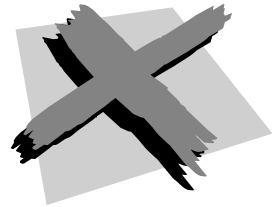

NO

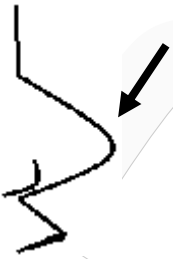

nose

n

Nn

1-Match the words with the pictures :

1-nose

2-No

3- nine

4-fish

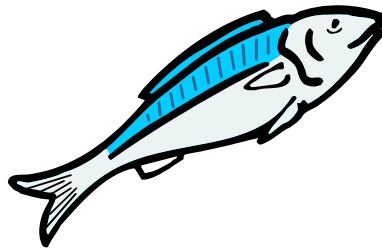

9

Oo

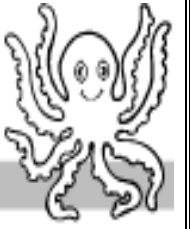

Oo

O O O O O O O

o o o o o o o o o o

Oo Oo Oo Oo

Oo

octopus octopus

octopus

Oo



15-Colour and say:

1

O

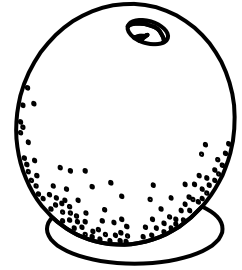

one

O

orange

Fun Zone

1-Match and colour :

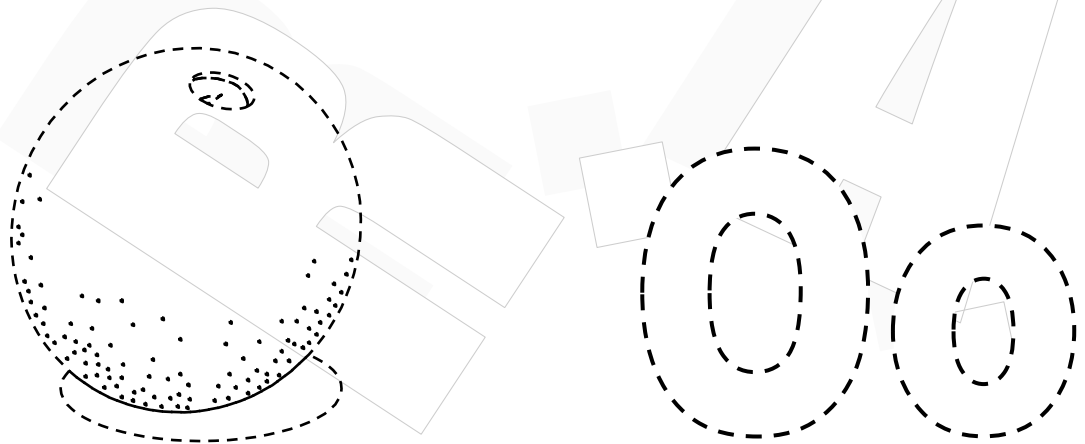

2-Match the words with the pictures :

1-five

2-one

3-orange

4- hen



5



Pp



Pp

P P P P P P P P P P

p p p p p p p p p p

Pp Pp Pp Pp Pp Pp Pp Pp

Pp

parrot parrot parrot

parrot

Pp



16-Colour and say:

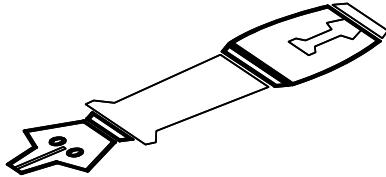

pen

P



pencil

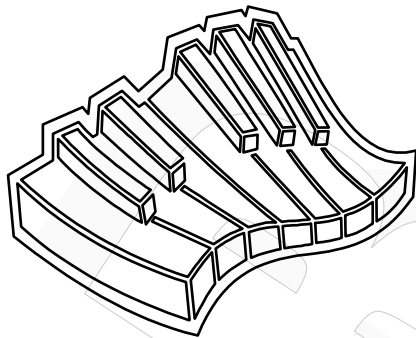

piano

p



play

Fun Zone

1-Match and colour :

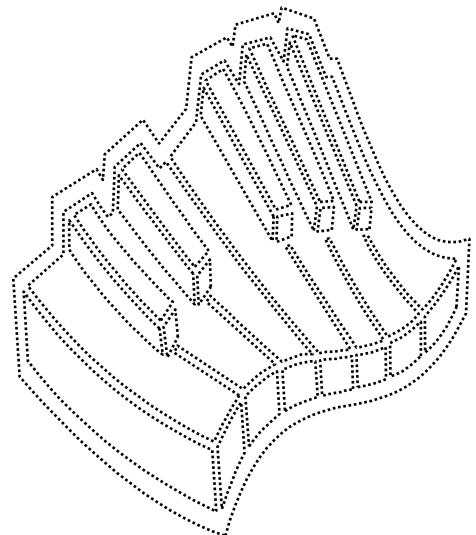
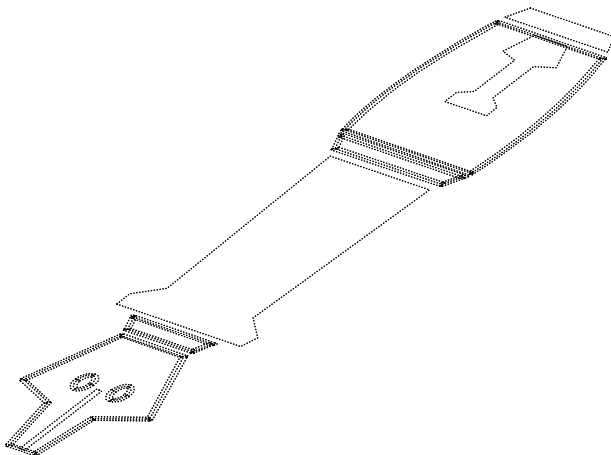

2-Match the words with the pictures :

1-pen

2-pencil

3-play

4-plane

5- piano

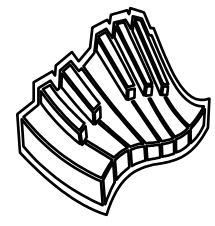

3- LISTEN AND CIRCLE THE CORRECT PICTURE

1.



2.

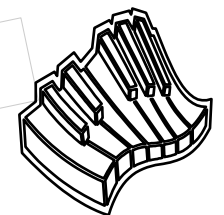

3.

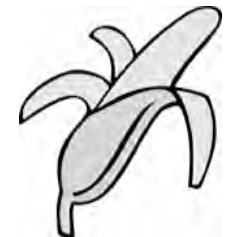

4.



Qq



Qq

Q Q Q Q Q Q Q

q q q q q q q q q

Qq Qq Qq Qq Qq

Qq

quilt quilt quilt quilt

quilt

Qq



17-Colour and say:



queen

Qq

1-Rearrange the following letters to make meaningful words:

1- pne

2- pencli

3- plya

.....

.....

.....

5- piaon

7- kiet

6- cta

.....

.....

.....

2-Match the words with the pictures :

1-queen

2-kite

3- banana

4-book

5-bee

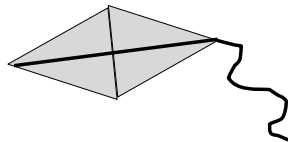

Rr



Rr

R R R R R R R R R R R R R R R R

r r r r r r r r r r r r r r r r

Rr Rr Rr Rr Rr Rr Rr Rr Rr Rr

Rr

rabbit rabbit rabbit

rabbit

Rr



18-Colour and say:

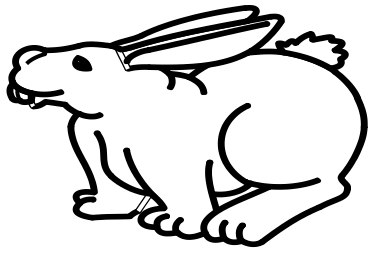

rabbit



rat

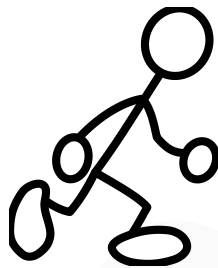

run

Rr

1-Write the first letter:



2-Match the words with the pictures :

1-rabbit

2-rat

3-run

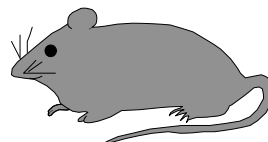

Ss



Ss

S S S S S S S S S

s s s s s s s s s s

Ss Ss Ss Ss Ss Ss

Ss

star star star star

star

Ss



19-Colour and say:

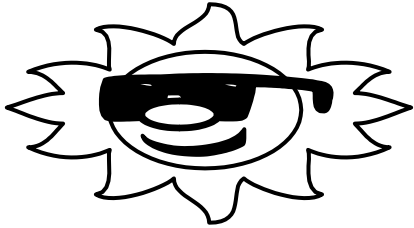

sun



star

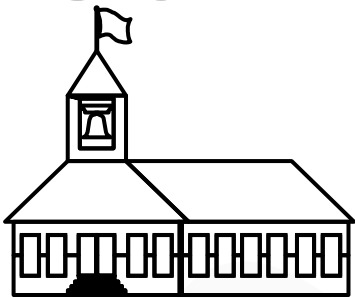

school

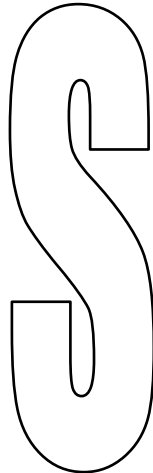

6

six

7



Ss

seven

Fun Zone

1-Match and colour:

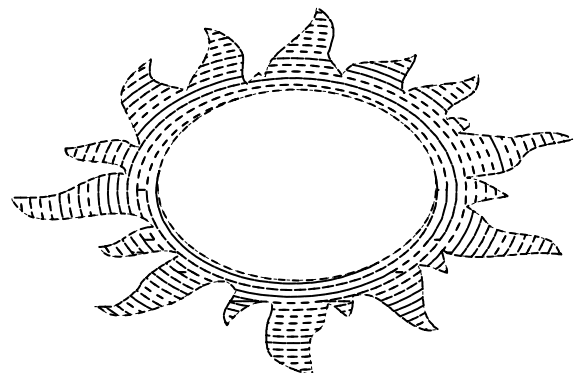
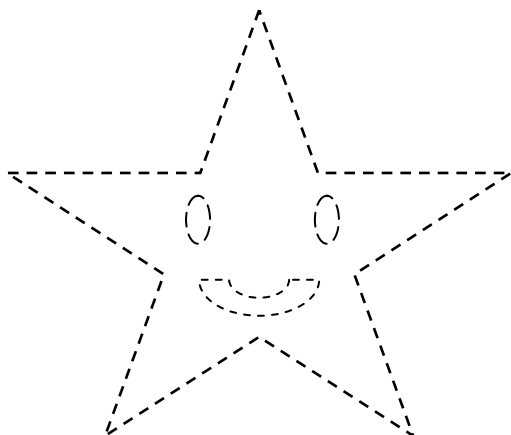

2-Listen and do :

- 1- Stand up.
- 2- Sit down.
- 3- Open your book.
- 4- Close your book.
- 5- Spell your name.

3-Draw , colour and say:

one apple	two apples	three apples
one book	two books	three books
one boy	two boys	three boys

Tt



Tt

Tt (with stroke order arrows and numbers 1 and 2)

Tt (with stroke order arrows and numbers 1 and 2)

Tt (dotted for tracing)

Tt (solid)

tiger tiger tiger tiger

tiger

Tt

20-Colour and say:



2
two



tree

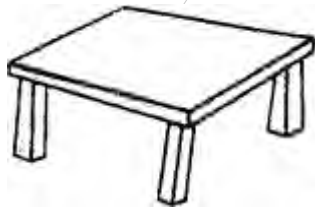

table

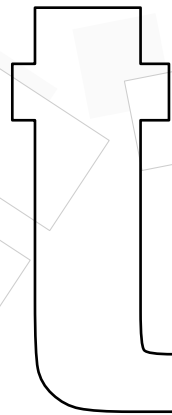
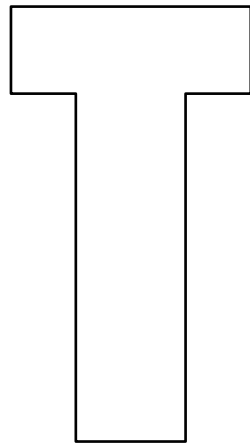

10
ten

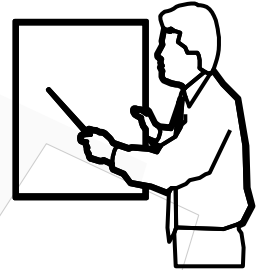

teacher



telephone

1-Match and say the numbers :

1- 4

2- 5

3- 6

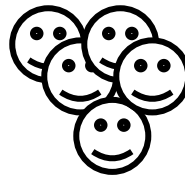
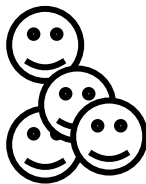

Uu



Uu

U U U U U U U U

u u u u u u u u

Uu Uu Uu Uu Uu

Uu

umbrella umbrella

umbrella

Uu

21-Colour and say:

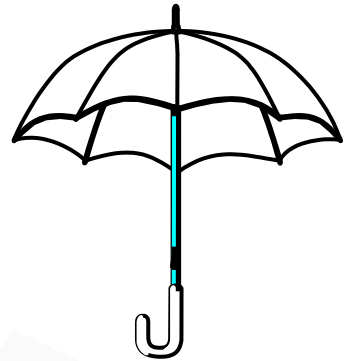
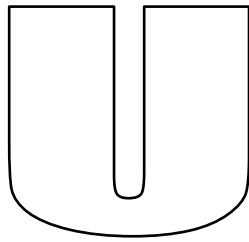

under

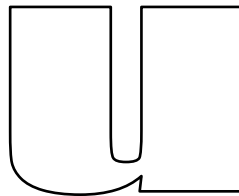

umbrella

1-Match the words with the pictures :

1- umbrella

2- book

3-tree

4-table

5-telephone

6-two

7-teacher

8-seven

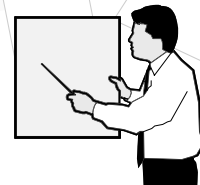

2- Write the capital letters for the following small letters :

a b c d e f

.....

g h i j k l

.....

m n o p q r

.....

s t u

.....

3- Look at the pictures. Read the words and circle (Yes) or (No):

Yes	✓	No	X
-----	---	----	---

1- A tree.

Yes

No



2- A boy.

Yes

No



3- A book.

Yes

No



4- An egg .

Yes

No

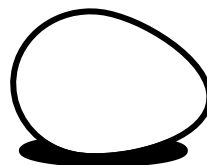

Vv

Vv



V V V V V V V V V V

v v v v v v v v v v

Vv Vv Vv Vv Vv Vv

Vv

vegetables vegetables

vegetables

Vv



22-Colour and say:



van

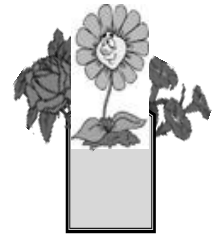
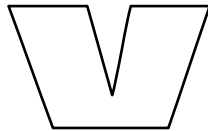
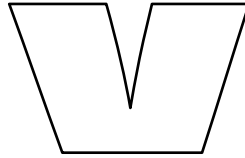

vase

1-Match the numbers :

- 1-one
- 2-two
- 3-three
- 4-five
- 5-four
- 6-six
- 7-seven

4

2

5

3

6

1

7

2- Look at the pictures and the letters , then write the words :

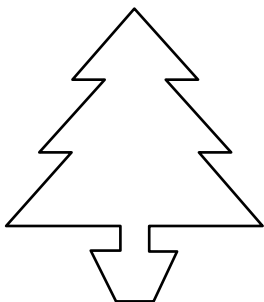

teer

.....

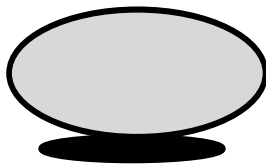

gge

.....



oby

.....

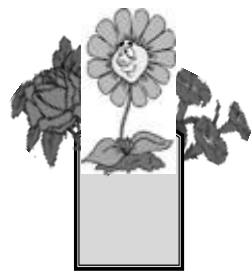

vaes

.....

Ww

Ww



Ww (with stroke order arrows 1-4)

w (with stroke order arrows 1-4)

Ww (dotted for tracing)

Ww (solid)

whale (solid) whale (dotted) whale (dotted)

whale (solid)

Ww



23-Colour and say:

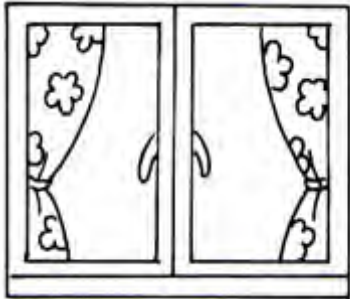

window



write

Fun Zone

1-Match and colour:

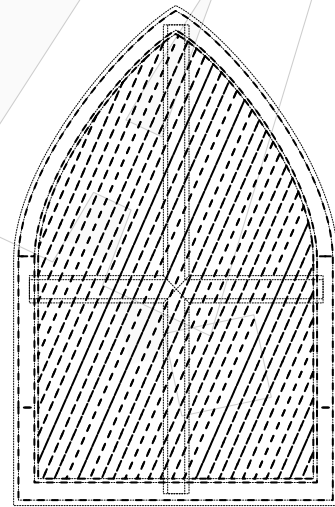

2-Match the words with the pictures :

1-window

2-write

3-van

4-vase

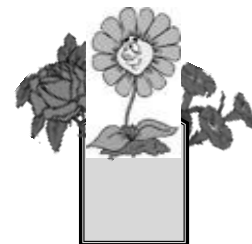
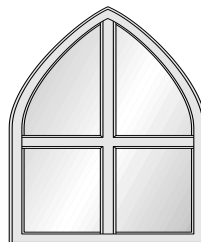

Xx

Xx



X X X X X X X X X X

x x x x x x x x x x

Xx Xx Xx Xx Xx Xx Xx Xx

Xx

xylophone xylophone

xylophone

Xx



24-Colour and say:

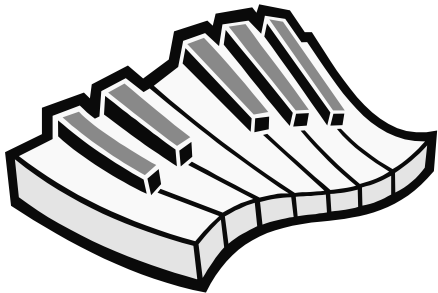

xylophone

Xx

Fun Zone

1-Match and colour:

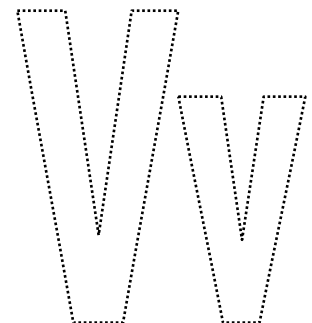
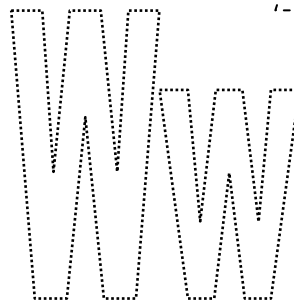
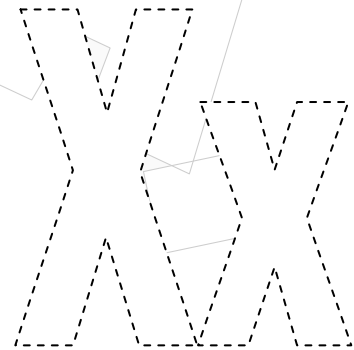
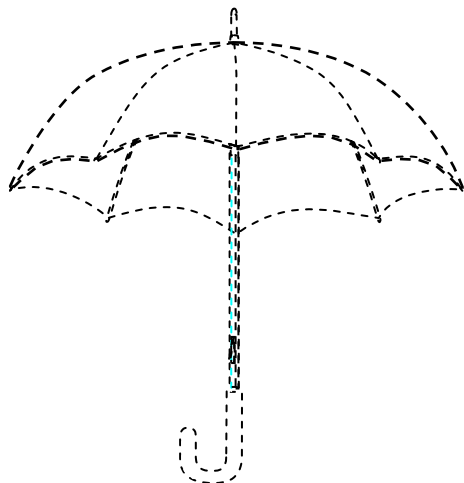
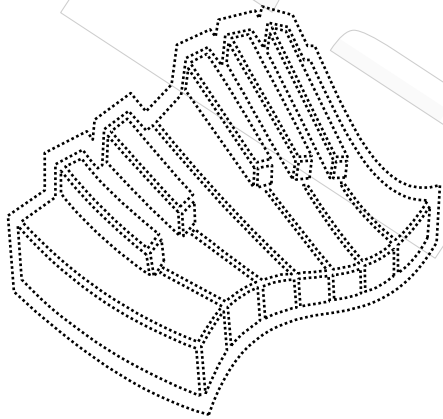

2-Match the words with the pictures :

1-six

2-ten

3-tree

4-xylophone

5-taxi

6-sun

7-star

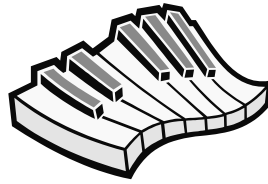

6

10



3- Listen to the words and circle the right picture :

1-

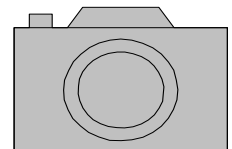
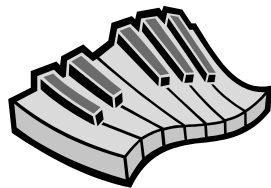

2-

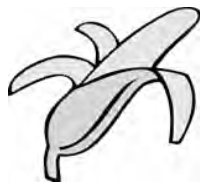

3-

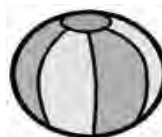

Yy

Yy



Y Y Y Y Y Y Y Y Y Y

y y y y y y y y y y

Yy Yy Yy Yy Yy Yy Yy Yy

Yy Yy

yarn yarn yarn yarn

yarn

Yy



25-Colour and say:



yoyo

Y



yellow



Yes

Y



you

1-Match the words with the pictures :

1-yoyo

2-yes

3-boy

4-fish

5-you

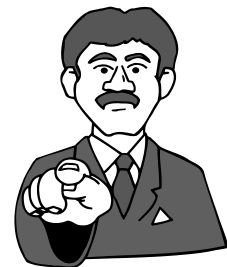
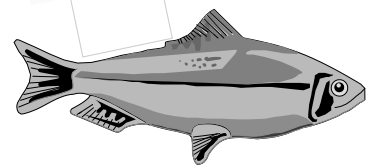

YOU!



Zz

Zz



Z Z Z Z Z Z Z Z

z z z z z z z z

Zz Zz Zz Zz Zz Zz

Zz

zebra zebra zebra

zebra

Zz

26-Colour and say:



zoo

Z



zebra

0

zero

Z

1-Match the words with the pictures :

1-zoo

2-zero

3-zebra

4-rat

5-queen

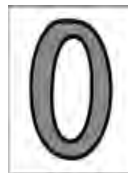

2-Write the number under each box:

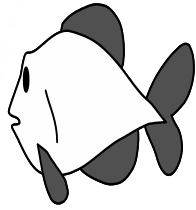



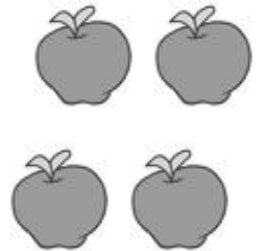

3- Look at the pictures. Read the words and circle (Yes) or (No):

Yes



No

X

1- A zoo.

Yes

No



2- A zebra.

Yes

No

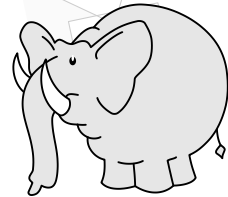

3- A hen.

Yes

No



4- A pen.

Yes

No

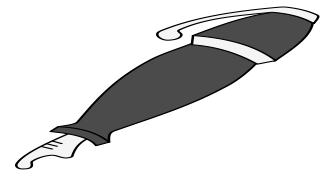

5- An arm .

Yes

No



Mr Ragab's Mini-dictionary

apple

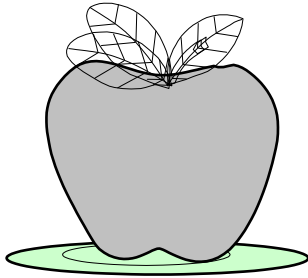

Aa

book

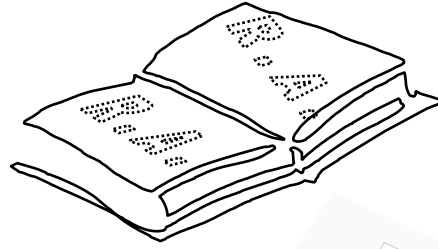

Bb

car



Cc

dog



Dd

egg

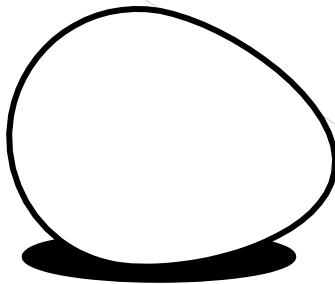

Ee

fish



Ff

girl



Gg

hat

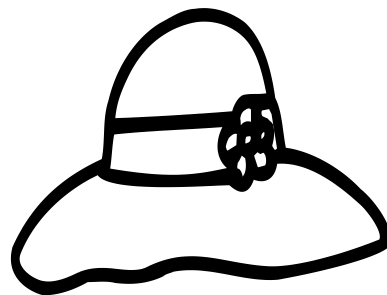

Hh

ice cream



Ii

jacket



Jj

kite

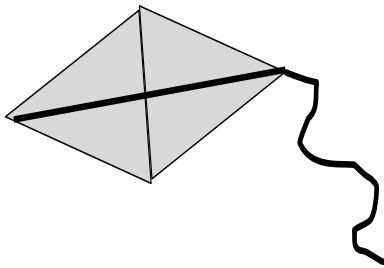

Kk

lion

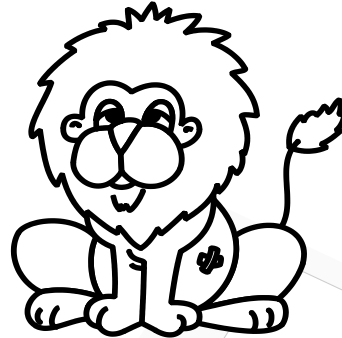

Ll

mouse



Mm

nose

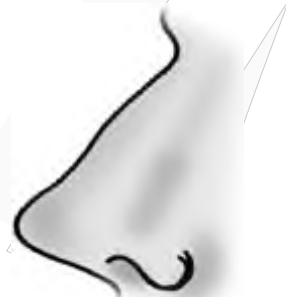

Nn

orange

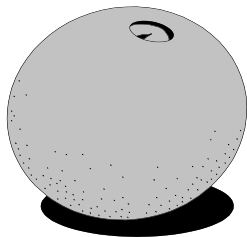

Oo

pencil

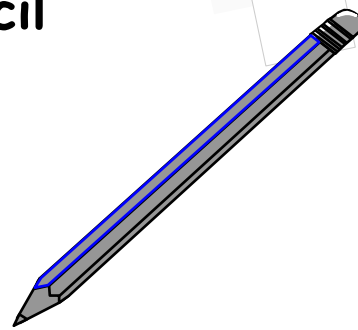

Pp

queen



Qq

rabbit

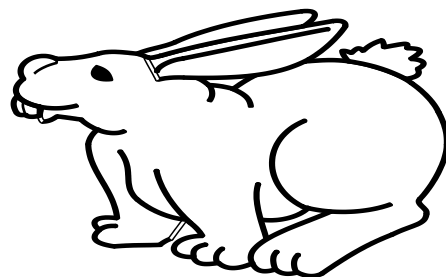

Rr

sun

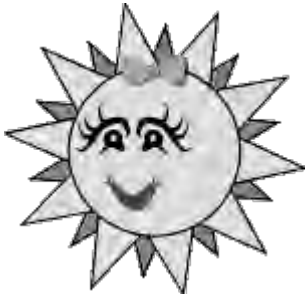

Ss

tree



Tt

umbrella



Uu

vase



Vv

window

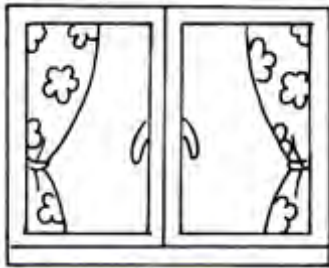

Ww

x

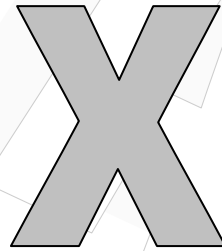

Xx

yoyo



Yy

zoo



Zz

By:

Mr Ragab Ahmed

Compiled by: Mr Ragab Ahmed



Mr Ragab's mini-dictionary



Aa

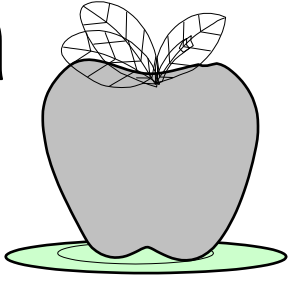

apple تفاحة



ant نملة

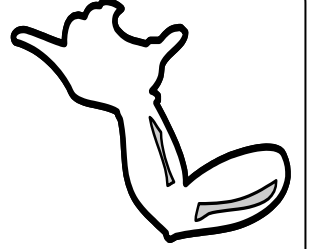

arm ذراع

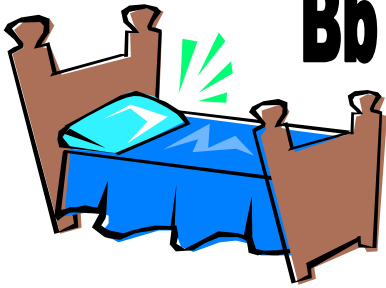

bed سرير



bag شنطة



bedroom حجرة النوم

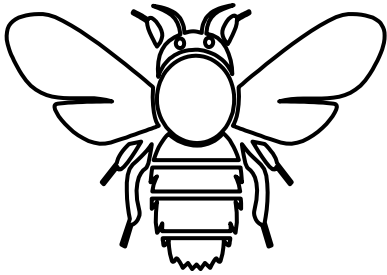

bee نحلة

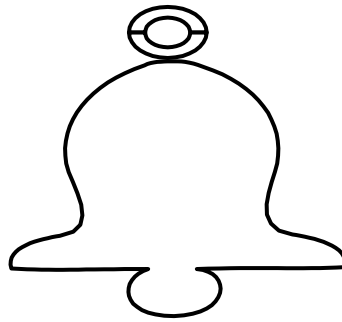

bell جرس



black اللون الأسود



blue اللون الأزرق



book كتاب



boy ولد

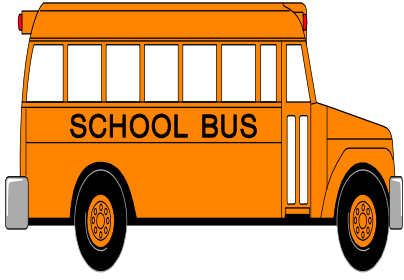

bus أتوبيس



ball كرة

Cc



cat قطة



car سيارة

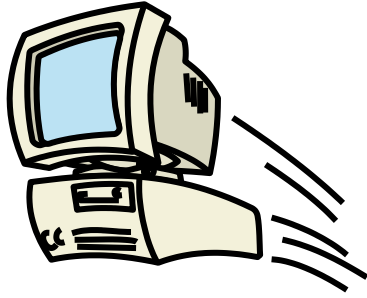

computer حاسب آلي

Dd

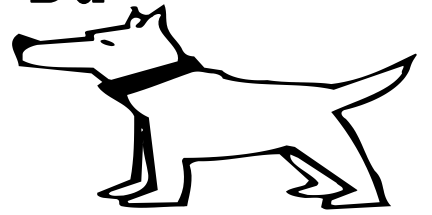

dog كلب



donkey حمار

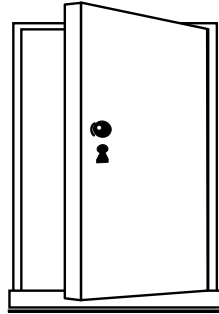

door باب

Ee

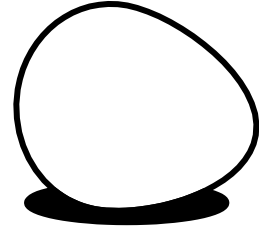

egg بيضة



elephant فيل

Ff



father بابا



family عائلة ، أسرة



fish سمكة

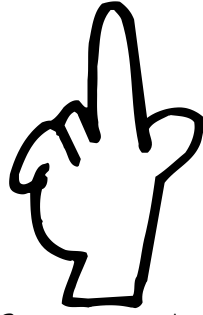

finger إصبع اليد



flag علم

Gg



girl بنت



goat معزة



green اللون الأخضر

Hh



hat برنيطة



house منزل



ice cream آيس كريم

Ii

Jj



jacket جاكيت



jump يقفز

Kk

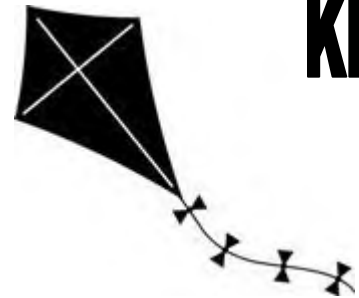

kite طائرة ورق

Ll

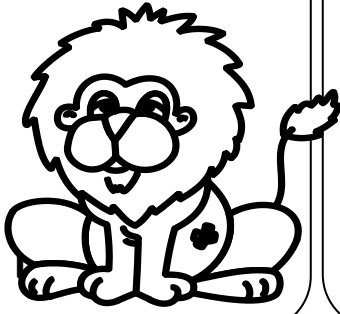

مصاصة
lollipop

Mm



فأر صغير
mouse



أم
mother



سجادة
mat

Nn



أنف
nose

9

تسعة
nine

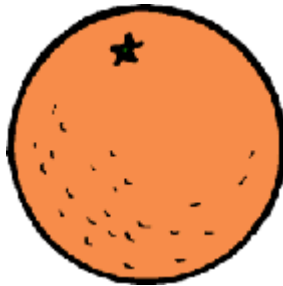

برتقالة
orange

Oo

1

واحد
one

Pp



قلم رصاص
pencil

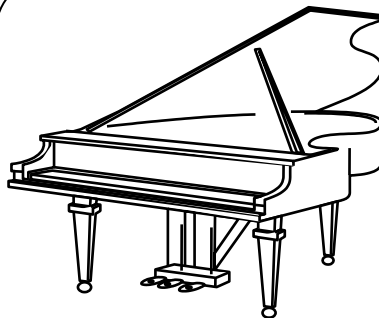

بيانو
piano

Qq



ملكة
queen

Rr



rabbit أرنب



run يجرى

Ss

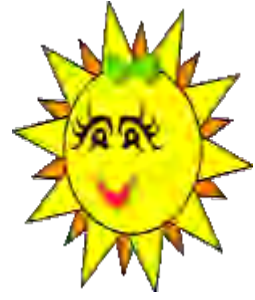

sun شمس

6

six ستة

7

seven سبعة

Tt

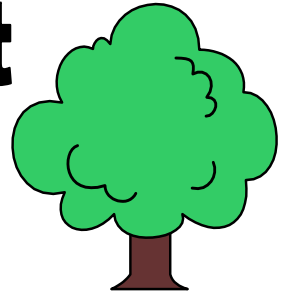

tree شجرة

Mr Ragab

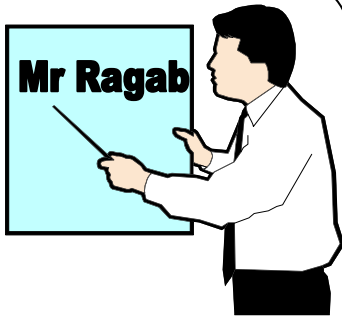

teacher مدرس

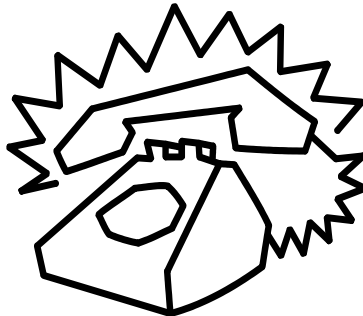

telephone تليفون

Uu



umbrella شمسية

Vv



vase زهرية

Ww



window شباك

Xx



xylophone آلة موسيقية

Yy



yoyo يويو

Zz



zoo حديقة حيوان



zebra حمار وحشي مخطط

Songs أغاني

✂ Leila has a little cat, a little cat, a little cat.

✂ Leila has a little cat.

✂ Its name is Mr Cat.



Children: Hello, teacher. Hello, teacher.

How are you? How are you?

Miss Mona: I'm fine, thank you.

I'm fine, thank you.

How are you? How are you?



Hi, rabbit! , Hi, rabbit!

Run! Run! Run!

Hi, rabbit! Hi, rabbit!

Run! Run! Run!

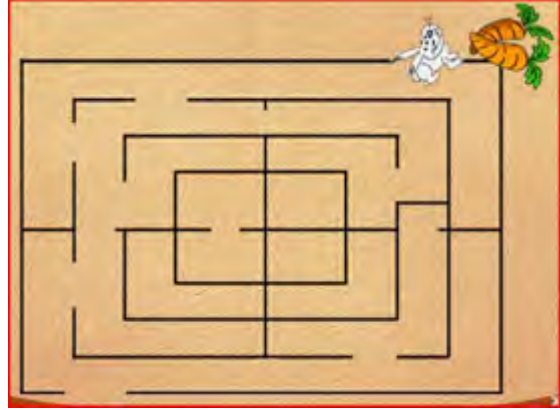

Singular & plural لمفرد و الجمع

Singular المفرد

Plural الجمع

car سيارة (واحدة)



cars سيارات



cat قطة (واحدة)



cats قطط



boy ولد (واحد)



boys أولاد



The Alphabet



Aa Bb Cc Dd Ee

Ff Gg Hh Ii Jj Kk

Ll Mm Nn Oo Pp

Qq Rr Ss Tt Uu Vv

Ww Xx Yy Zz

Numbers

zero 0	one 1	two 2	three 3	four 4
five 5	six 6	seven 7	eight 8	nine 9
ten 10	eleven 11	twelve 12	thirteen 13	fourteen 14
fifteen 15	sixteen 16	seventeen 17	eighteen 18	nineteen 19
twenty 20	twenty-one 21	twenty-two 22	twenty-three 23	twenty-four 24
twenty-five 25	twenty-six 26	twenty-seven 27	twenty-eight 28	twenty-nine 29
thirty 30	forty 40	fifty 50	sixty 60	seventy 70
eighty 80	ninety 90	a hundred 100	two hundred 200	three hundred 300
four hundred 400	five hundred 500	six hundred 600	seven hundred 700	eight hundred 800
nine hundred 900	a thousand 1000			

والسلام عليكم ورحمة الله وبركاته
أخوكم / مستر رجب

Compiled by: Mr Ragab Ahmed